



Replacement Windows

Comfort. Beauty. Energy Efficiency.



Longevity



Trustworthy



Traditional



Charming





Durable



Timeless

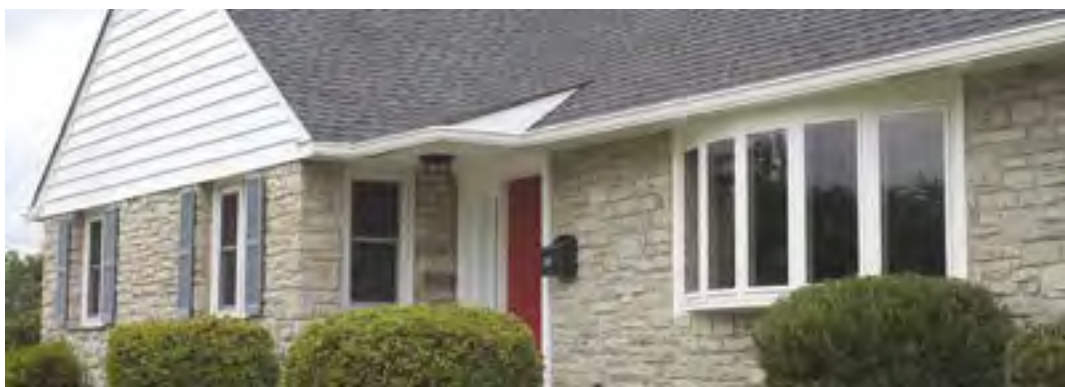

Reliable

Table of Contents

Introduction to Cambridge and Edgemont Windows	1
Glazing	3
Cambridge Replacement Windows	7
Cambridge Double-Hung Diagram	9
Edgemont Replacement Windows	11
Edgemont Double-Hung Diagram	13
Combination Units	15
Picture & Geometric Windows	17
Casement & Awning Windows	19
Sliding Windows	21
Bay & Bow Windows	23
Patio Doors	25
Options	27
Colors and Laminates	29
Simulated Divided Lites (SDLs) and Grids	31
Specialty Glass	32
Hardware	33
Screens	34





From the warmest parts of the country to the most frigid,

homeowners choose Viwinco's custom-built replacement windows for renovations large and small. Whether you're seeking to upgrade the look and value of your home, or increase its energy efficiency, Viwinco meets your needs. We do so quickly and with the personal attention that only a family-owned and operated company can provide. Our in-house production system enables us to fill standard orders with faster turnarounds. It also allows us control over each stage of the manufacturing process, from the moment your order is entered in our system up through the final steps, when we hand-clean and wrap your finished windows. We even ensure the safe delivery of your order on our own fleet of trucks.

Viwinco offers two high-performance replacement products to meet your needs.

Cambridge:

Our premier replacement window is loaded with top features and performance. Available with all our options, Cambridge windows come with a lifetime warranty—which also includes glass breakage.

Cambridge Styles

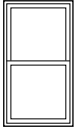
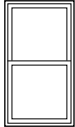
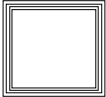
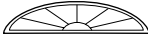
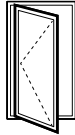
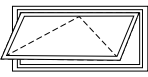
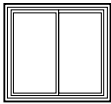
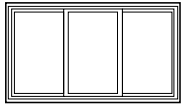
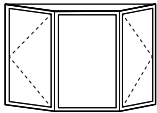
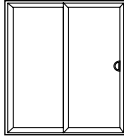
				
Double-Hung <small>(both sashes are operable)</small>	Single-Hung <small>(bottom sash is operable)</small>	Picture	Geometric	Casement
				
Awning	2-Lite Slider	3-Lite Slider	Bay & Bow	Patio Doors 2-, 3-, & 4-lite

Edgemont

An attractive, clean and simple design defines our Edgemont product line. Edgemont windows provide energy efficiency and affordability to every homeowner.

Edgemont Styles

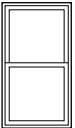
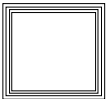
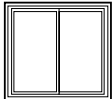
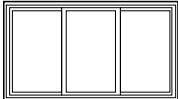
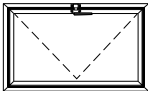
				
Double-Hung <small>(both sashes are operable)</small>	Picture	2-Lite Slider	3-Lite Slider	Hopper

Double-hung Cambridge windows with a custom grid pattern in the top sash and bronze exterior blend right in with the unique character of this historic home, built in 1875.







Year-Round Home Co.



Glazing

You spend a great deal of time and energy determining where you want to live and creating your ideal setting inside.

Living with drafts and heat loss can strain both your endurance and your wallet.

That's why replacing old windows constitutes a major home improvement—one that impacts the quality of your life. When you choose top-performing products, you transform the world within your home, making it more comfortable, more beautiful, and more energy efficient.

Glazing refers to the part of the window comprised of glass. It is the aspect of window design and production that determines everything from the amount of light your windows let in, to the level of thermal insulation they offer. Viwinco's high-performance glass package included in every window we manufacture, features **double glazing**, or two panes of glass.

A **Low-Emissivity (Low-E)**, microscopically thin, transparent coating is applied to one of these panes. It allows for optimal transmission of visible light (the light that brings brightness to your home), while simultaneously preventing the transfer of invisible UV and infrared light.

- **Brightness:** Low-E transmits more than 70% of the sun's available light. More visible light = less electricity use, and healthier living; light has been shown to have a positive impact on a person's mood.
- **Protection:** Nearly 80% of UV energy—the invisible light that damages furniture, fabrics, and other surfaces—is reflected back outside.
- **Control:** In the summer, short-wave infrared energy, experienced as heat, is reflected back to the sun, keeping your home cool and your air conditioning working efficiently and effectively. In winter, long-wave infrared energy, which emanates from surfaces and objects within your home, is either absorbed by the Low-E coating or reflected back inside; the coating works like a thermos, blocking heat from escaping. No matter the season, the temperature within your home is maintained.

comfort.

In harmony with the environment: a combination of window styles creates balance and interest, magnifying the beauty of the surroundings.

Double Glazing, Continued →

Our Standard High-Performance Insulated Glass Unit (IGU)

- Double-strength Low-E glass
- Argon gas fill
- Energy efficient spacer

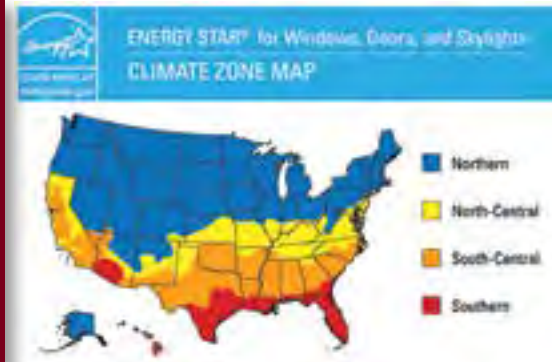

Typical Window
3/4" single-strength,
insulated glass unit

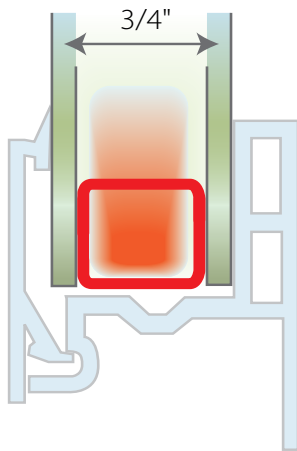

Viwinco Edgemont®
3/4" double-strength,
insulated glass unit with
Low-E glass and argon gas

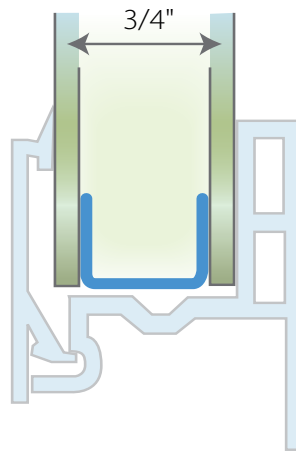

Viwinco Cambridge®
15/16" double-strength,
insulated glass unit with
Low-E glass and argon gas

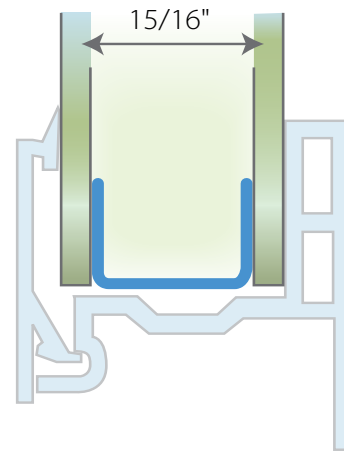

ARGON GAS:

An odorless, colorless, and nontoxic heavy inert gas with excellent insulating properties, argon gas fills the dead air space created by the double panes in an IGU. Its low-conductivity is great for thermal performance. After the unit is filled with the gas, it is hermetically sealed. In addition to increasing thermal efficiency, argon gas contributes significantly to sound reduction.

ENERGY EFFICIENT SPACER:

The spacer, represented by the blue, rectangular "U" shape in the center and right diagrams above, is a vital part of the IGU. It holds the glass panes together while acting as an insulating barrier at the edge of the unit, where an additional seal is essential. Constructed using high-performance grade materials for low conductivity and strength, the spacer we use effectively stops the transfer and loss of heat.

Seal Out Moisture and Drafts.



Vinco's three-panel patio door with center operating unit provides an unbeatable view of fields, forest, and mountains stretching before this cabin retreat. Since the unit leads into the kitchen/living area, products that offer excellent thermal insulation were imperative to the homeowner.

U-FACTOR and R-VALUE:

The U-factor is a numerical rating that indicates how much heat is transferred or lost through a window. Highly insulating windows have low U-factors. The R-value, on the other hand, expresses the window's resistance to heat flow; the higher the R-value, the better its insulating properties. The R-value is the inverse of the U-factor; a window with a .30 U-factor has an R-value of 3.3.

SOLAR HEAT GAIN COEFFICIENT (SHGC):

The SHGC is a measure of how much solar heat passes through a window. In colder climates, a higher solar heat gain is desirable; in warmer climates, the opposite is true. SHGC is measured on a scale of 0-1, with 0 denoting the lowest SHGC and 1 denoting the highest.

Ratings for U-factor, SHGC, and Visible Transmittance (the relative amount of visible light transmitted through the window) are displayed on the National Fenestration Rating Council (NFRC) Label, which you can find on all of our products. To view a sample label and learn more about thermal performance, go to www.Vinco.com for more information.



Tilt-*n*-Lock

HARDWARE

Exclusive Technology:

- One-handed operation
- Clean sight lines
- Easier cleaning

Available on *CAMBRIDGE*
single- and double-hung windows



Locked Position

Sash is securely locked.
Hidden tilt latches are
housed in sash channel
for added strength.



Unlocked Position

At the 150-degree position,
the hidden tilt latches are
engaged with the jamb,
and the sash can be lifted.



Tilt-In Position

When the lever is moved to
180-degrees, the hidden tilt
latches clear the jamb channel,
allowing the user to easily tilt
the sash inward.





Cambridge

Replacement Windows.

Excellence. It's built into every detail of our Cambridge window. When we designed the vinyl frame profile, we prioritized robustness: manufactured with more PVC than the competition, multi-chambered and fusion welded, it provides a lifetime of durability. The frame also offers top weatherability, color retention, and extremely low-maintenance. Unlike wood, vinyl never rots, chips or needs painting. In terms of glazing, the 15/16" double-strength glass package stands out for its superior insulating properties. The design, which features our Tilt-*n*-Lock hardware on hung windows, brings beauty, ease of use, and ingenuity together.

Cambridge windows come standard with some of the finest features our industry has to offer—and every option that Viwinco offers, too. See pages 27-34 to learn more about color choices, simulated divided lites, and more.

Cambridge Styles

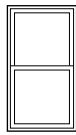

Double-Hung



Single-Hung



Oriel

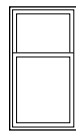

Reverse Oriel

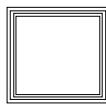

Picture



Geometric

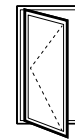

Casement

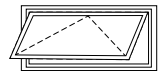

Awning

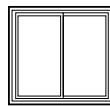

2-Lite Slider

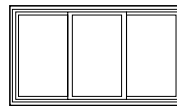

3-Lite Slider

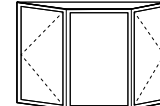

Bay & Bow

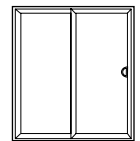

**Patio Doors
2-, 3-, & 4-lite**



The colonial home pictured left contains Cambridge **double-hung** and **twin double-hung** windows with deluxe contoured grids. Double-hung windows feature two operable sashes; the lower sash lifts up and the top pulls down. They offer classic looks, versatility, and great ventilation.

Our Cambridge **single-hung** windows also contain two sashes, but only the lower one is movable. The dual-sash design ensures a trouble-free installation. Since single-hungs match the look of our double-hungs, you can install both types of windows in different areas of your home and still achieve a consistent look.

Premier Performance

Cambridge. Available *in all Viwinco styles, with any of our options.*

Cambridge® single- and double-hung units include:

Our standard high-performance glass package with 15/16" double-strength insulated glass

- Tilt-*n*-Lock patented technology
- 3/4" Stainless steel constant-force balance system

Cambridge Standard Features

1. **Chambered, thick 100% virgin vinyl profiles** add thermal efficiency and structural strength for superior performance
2. **Beveled exterior** for a craftsman look and architectural appeal
3. **15/16" Double-strength insulated glass unit** with Low-E, thermally efficient spacer, and argon gas fill for top insulating value
- *4. **Tilt-*n*-Lock hardware**, standard on Cambridge single- and double-hung windows, provides strength where it's most needed—along the interlock. The reinforcement becomes the housing for the hardware that allows you to use the lock to tilt the sash in with just one hand. Tilt latches are not visible
5. **Sash interlock** hooks the sashes to each other and to the frame on hung windows, providing increased thermal efficiency by blocking air from entering or escaping
6. **5° True sloped sill** directs water and debris away from your home
7. **Screen track** keeps screen in place to better block insects
8. **Sill angle accessory pocket** simplifies sill angle installation
9. **Fully fusion-welded frames and sashes** for strength, durability and low-maintenance. Welded corners are permanently sealed
10. **Dual nite vents** for increased control over air ventilation
11. **Unique triple weatherstripping** for enhanced thermal efficiency
12. **Stainless steel, 3/4" constant-force balance** eliminates sash drift and never needs adjusting
13. **Coextruded glazing bead** around perimeter of glass is specifically designed with a flexible edge to ensure a weathertight fit
14. **1-3/8" Weatherstripped, replaceable sill dam** is mortised into the jamb, providing aesthetic appeal, ease of installation, and superior protection against drafts and water infiltration
15. **Molded-in, curved lift rails** on both sashes make operation easy and comfortable

Heavy-duty extruded locking half-screens are standard. See page 34 for a description and screen options.



Cambridge single-hung windows are engineered with two sashes for equal sight lines and to match the look of a double-hung. Only the lower sash is operable.

Our Cambridge warranty includes **LIFETIME GLASS BREAKAGE COVERAGE** in addition to limited lifetime coverage on sash, frame, and hardware. For more details see www.Viwinco.com

Cambridge Double-Hung



Edgemont[®]

Replacement Windows

Value. You add it to your home with every investment. Replacing inefficient windows is one of the most important upgrades you can make. Doing so saves you money on energy bills by reducing the drafts and heat loss older windows can contribute to in winter. It also increases energy efficiency during the summer because your air conditioning works faster and more effectively to cool your home.

Edgemont windows provide the long-lasting durability you deserve at an affordable price. Like all Viwinco windows, they're custom-sized to your exact dimensions to ensure a perfect fit, with no filling or patching necessary.

Edgemont windows are available in white or tan. Other options include grids, and colored glass.

Edgemont Styles:

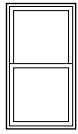

Double-Hung

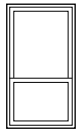

Oriel

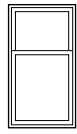

Reverse Oriel

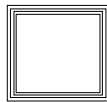

Picture

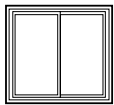

2-Lite Slider

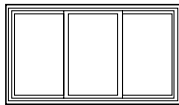

3-Lite Slider

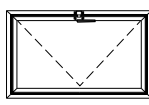

Hopper



Right: Edgemont replacement double-hungs add a touch of radiance to this homey split-level.

Above: Interior view of an Edgemont picture window flanked by double-hungs.

We offer varied combination units in our Edgemont line.





Performance

You Can Count On

Our Edgemont replacement line offers exceptional value at a cost-effective price.

Edgemont double-hung units include:

- ▶ Our high-performance glass package with 3/4" double-strength insulated glass
- ▶ Fusion-welded frame and sashes with interlock for increased thermal efficiency
- ▶ 1/2" Stainless steel, constant-force balance system

Edgemont Standard Features

1. **Chambered, 100% virgin vinyl profiles** add thermal efficiency and structural strength
2. **Beveled exterior** for traditional styling
3. **3/4" Insulated glass units** with Low-E double-strength glass, thermally efficient spacer, and argon gas fill are standard and contribute to excellent thermal performance
4. **Cam-style lock** with adjustable keeper for reliable alignment and positive locking
5. **Sash interlock** hooks the bottom and top sash to each other and to the frame on hung windows, providing increased thermal efficiency by blocking air from entering or escaping
6. **5° True sloped sill** directs water and debris away from your home
7. **Screen track** keeps screen in place to better block insects
8. **Sill angle accessory pocket** simplifies sill angle installation
9. **Fully fusion-welded frame and sashes** contribute to thermal performance, durability, and low-maintenance. Welded corners are permanently sealed
10. **Dual nite vents** limit sash travel for increased control over ventilation
11. **Low-profile tilt latches** provide an uncluttered view
12. **Double weatherstripping** adds to thermal performance
13. **Stainless steel, 1/2" constant-force balance** eliminates sash drift and never needs adjusting, allowing for easy window operation time after time
14. **1-1/8" Weatherstripped, replaceable sill dam** is mortised into the jamb, providing aesthetic appeal, ease of installation, and protection against drafts and water infiltration
15. **Molded-in, curved lift rails** on both sashes make sash operation easy and comfortable
16. **3/8" Trimmable leg flanges** can be cut down to fit slightly irregular rough openings

Heavy-duty extruded half-screens come standard on Edgemont products. For enhanced performance, we also offer the option of our heavy-duty extruded full screens. See page 34 for details.

Lifetime limited warranty coverage on insulated glass unit and hardware for as long as you own your home. For more details about our warranty, see www.Viwinco.com



Atmosphere.

Viwinco offers many different styles to match your vision for your home. If you love the idea of more light, consider joining two or more units together in a mull combination. Installed into one opening, mull units create the benefit of more visible glass and allow for expansive views.

Structural Mullions

Structural mullions provide increased integrity between horizontally and/or vertically adjacent mounted windows. A window-wall mull (integral mullion, below) is available for casements and awning windows; see page 19 for more information.

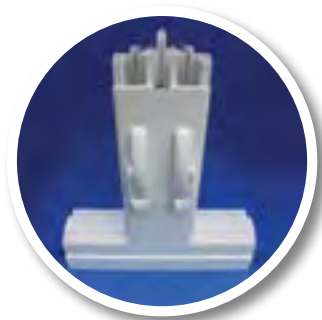

Integral Mullion
(continuous head and sill)
for mulling Cambridge casement,
casement picture, and awning windows.



Structural Mullion used to
mull two or more Cambridge units
together. Interior view.

Select Combinations

Available styles and combinations depend upon product line.

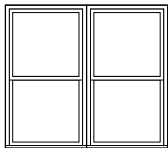

Twin Single- or
Double-Hung

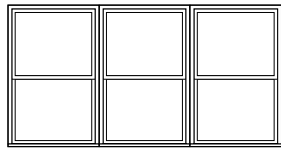

Triple Single- or
Double-Hung

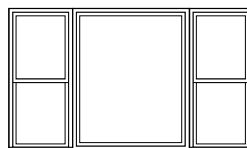

Double-Hung/Picture/Double-
Hung or Single-Hung/
Picture/Single-Hung

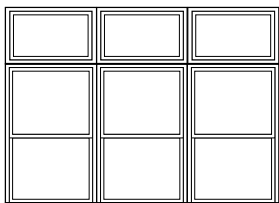

Triple Single- or Double-Hung
with Transoms above
(Cambridge only)

Colonial grids create the look of multiple panes of glass on these double-hung windows, capturing and enhancing the home's architectural style.

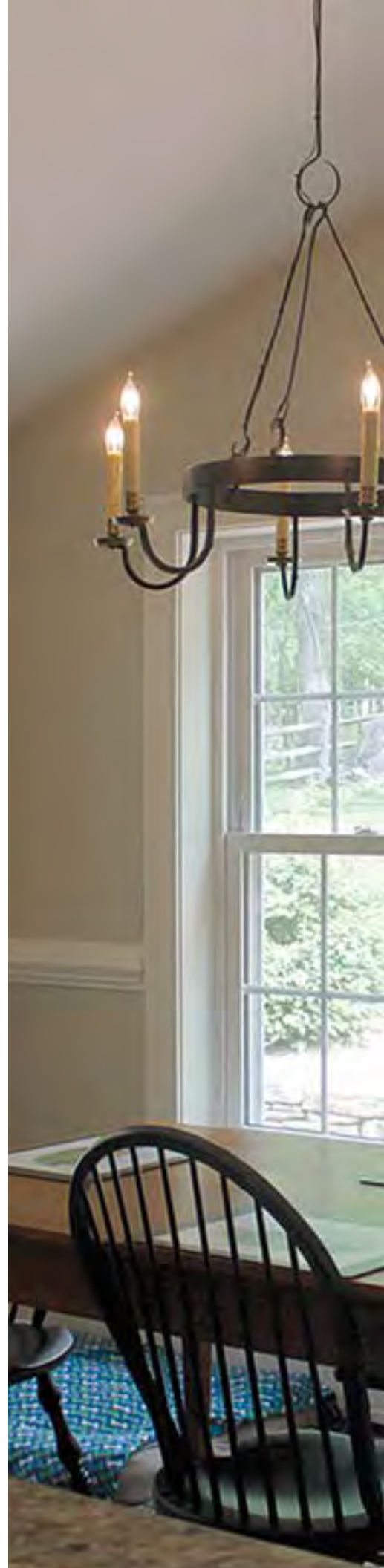







Picture Windows

A focal point. Picture windows add character to your home and provide one-of-a-kind, unforgettable views. Plus, their simple, open design enlarges the feeling in any room.

Picture windows keep out drafts and cold or damp air, and provide exceptional thermal performance in every season. At the same time, all the light they let in helps create a healthy, happy environment.

For color and option details, see pages 27-34.

Select Combinations

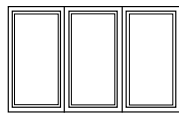

Triple Picture Unit



Transom over
Picture

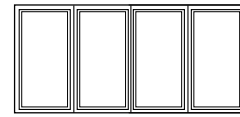

Quad Picture Unit
(Cambridge Only)

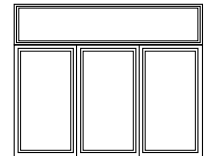

Transom over
Triple Picture Unit
(Cambridge Only)

Picture & Geometric Window Features

1. Our standard high-performance insulated glass unit with Low-E glass, thermally efficient spacer (Super Spacer® used on Geometric windows), and argon gas fill
2. Extruded glazing bead is mitered in the corners for a hand-crafted look
3. Fully fusion-welded frame for strength, durability and low-maintenance

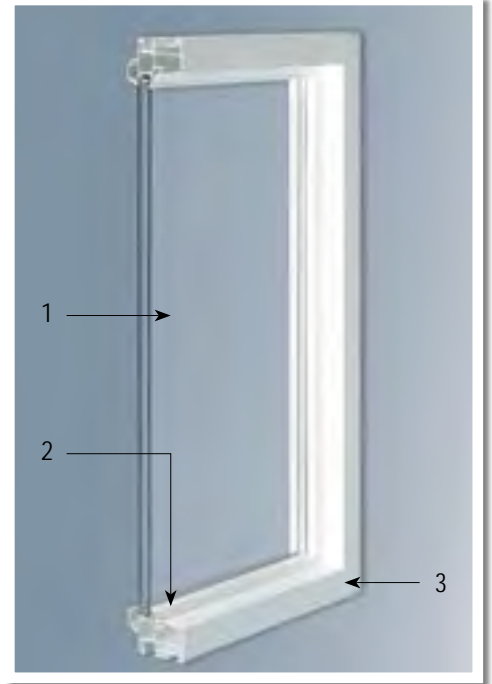

Geometric shapes such as this extended half-round (inset, left) are also available. Go to www.Viwinco.com for more information.



Large picture windows that extend nearly floor to ceiling are arranged next to each other for optimal natural light.

Casement and Awning Windows

Hinged on the side, casement windows swing open to the right or left. A great choice for anywhere in your home—or, for that matter, throughout. Since the entire sash opens, ventilation is maximized.

Colonial casements (near right) match the look of hung windows but include the added benefit of casement egress features. Fixed casements are available, too.

Offered only in our Cambridge line, casement windows are available with all of our color options. See pages 27-34 for option details.



Select Combinations

Handing is viewed from the outside.

Multiple casements or awnings may be combined to create a window-wall up to 144" wide. Our structurally reinforced window-wall mull maximizes visible glass between sashes.

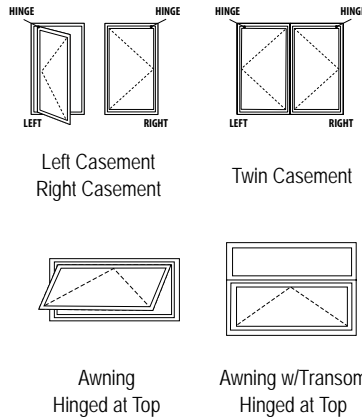

Casement & Awning Window Features

Casements include our 15/16" high-performance insulated glass unit with Low-E glass, thermally efficient spacer, argon gas, stainless steel hardware, and...

1. Operating hinges that open 90° to allow for easy cleaning. Optional egress hardware available
2. Multipoint lock for added security and snug sash closure
3. A folding handle design that tucks away for a streamlined, clean look. It means less interference with window treatments and easy removal of screens
4. Hardware attachment points that are reinforced for a lifetime of reliable operation
5. Integral glazing bead for a weather-tight seal

Triple weatherstripping for a tight seal against wind, water, sound, and airborne particles—as well as top thermal performance

Aluminum reinforcement in the sash and frame provides structural integrity

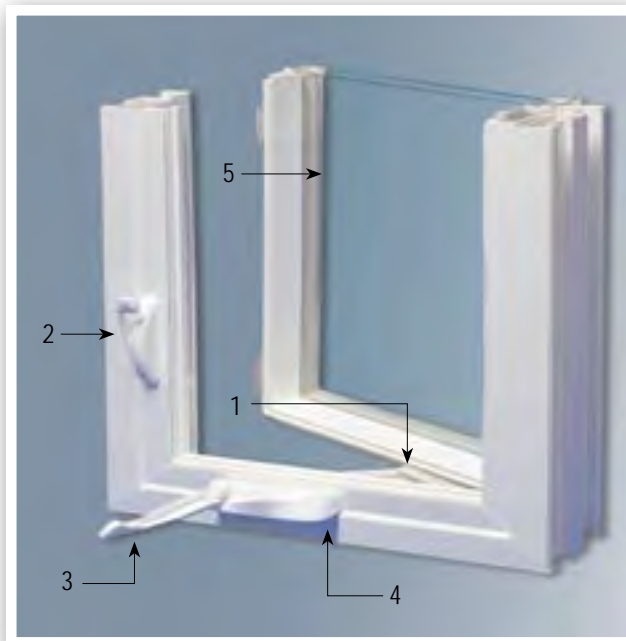

Far right: this casement/casement picture/casement combination adds a contemporary look and feel to the room, and emphasizes the view.

Inset: awning

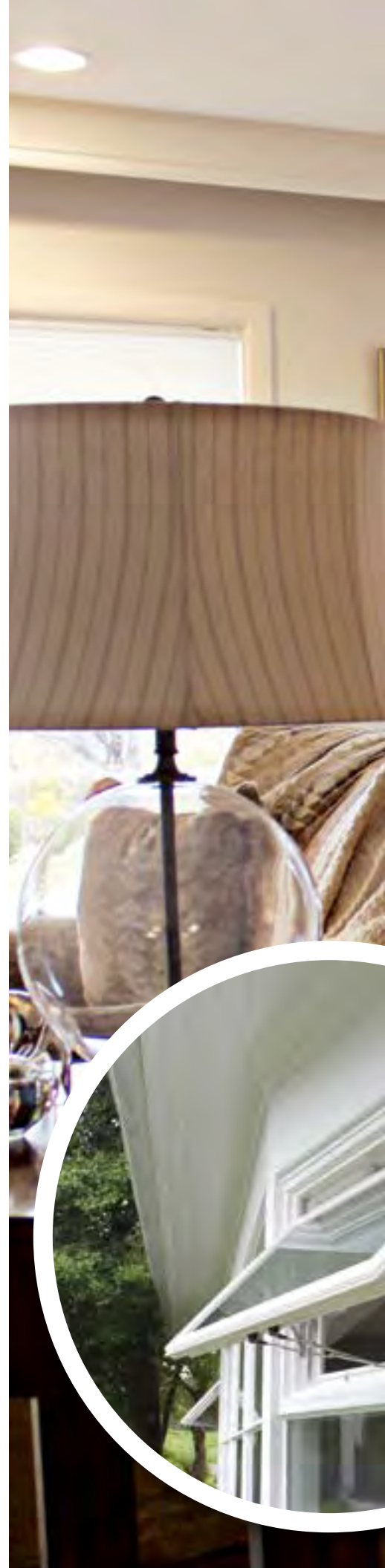



Awning windows offer the special feature of providing ventilation even during rainy days or nights. Hinged at the top, they swing outward, making them great for use above or below picture windows, or stacked on top of each other.





Sliding Windows, *also referred to as sliders,*

share the best feature of a casement window: the sash opens entirely, allowing in plentiful air and light. Unlike casements, sliders operate horizontally. Since they don't require any lifting force, they're particularly easy to operate.

For color and option details, see pages 27-34.

Style Options

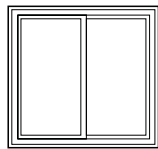

2-Lite (1/2-1/2)

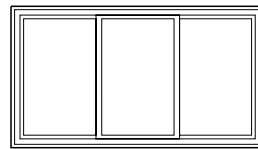

3-Lite (1/3-1/3-1/3)

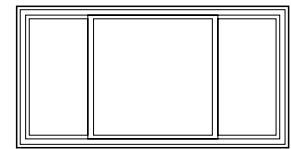

3-Lite (1/4-1/2-1/4)

Our 3-lite sliders feature a fixed center lite and venting end lites

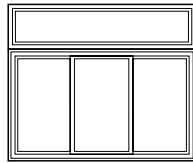

Transom over 3-Lite
(1/3-1/3-1/3)
(Cambridge Only)

Slider Features

1. Cam-style lock with adjustable keeper for reliable alignment and positive locking
2. Sash interlock for thermal performance, alignment, and strength
3. Our standard high-performance insulated glass unit with Low-E glass, thermally efficient spacer, and argon gas fill
4. Sash track with monorail-design slider pad on Cambridge windows provides smooth glide operation
5. Both sashes operate for ventilation, and both lift out for safe cleaning from inside your home
6. Extruded designer pull rails (on both sashes) make sash operation easy and comfortable
7. Fully fusion-welded frame and sash for structural strength and durability

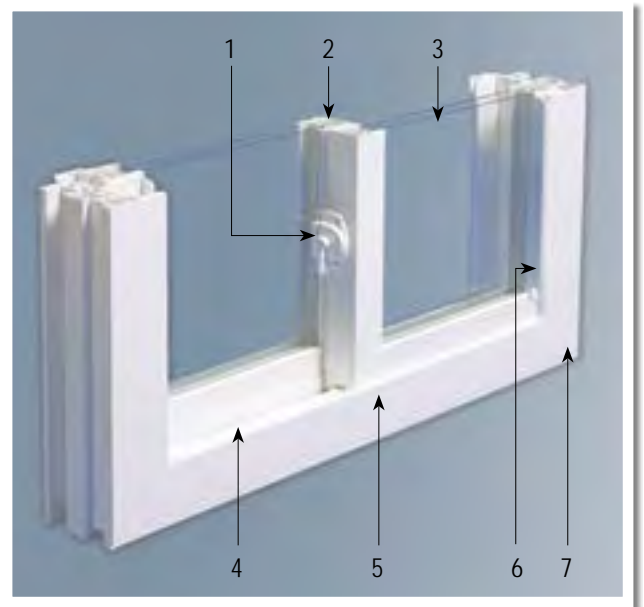

This clay Cambridge 2-Lite sliding window is the perfect fit, allowing plenty of light in while having the option to ventilate if desired.

Bay & Bow Windows

Some transformations to your home will change the way you feel about it forever. The addition of new replacement bay or bow windows is one of them. Both styles project outward, creating fluidity between inside and out.

Design your own bay or bow unit with Cambridge single-hung, double-hung, casement or picture styles. Custom jamb depths and projections are available.

- Fully fusion-welded vinyl frames for strength, durability and low-maintenance
- Chain suspension system attaches directly to the frame of the house for a structurally sound installation
- Tie rods uniting the headboard and seat board provide stability
- Headboard and seat board are manufactured from insulated marine-grade plywood with birch veneer. They're paintable or stainable to match your décor (oak veneer headboard and seat board also available as an upgrade)

Bays and bows are available with all of our color options. For color and option details, see pages 27-34.

Select Combinations

All Bays and Bows are comprised of Cambridge windows

Bay Windows

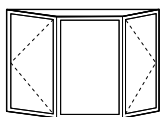

30° Bay

Casement/Casement Picture/
Casement

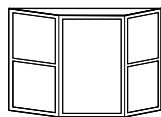

30° Bay

Double-Hung/
Picture/Double-Hung

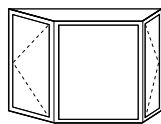

45° Bay

Casement/Casement Picture/
Casement

10° Bow Windows

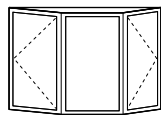

3-Lite

Casement/Casement Picture/
Casement

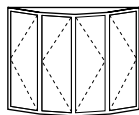

4-Lite

Casement/Casement/
Casement/Casement

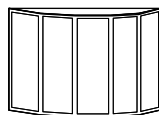

5-Lite

Picture/Picture/
Picture/Picture/Picture

Spaciousness abounds: this 5-lite bow unit, featuring two operable casement windows at each end with casement picture units in between, opens up the living area and recasts the front of this suburban home.







Style Options

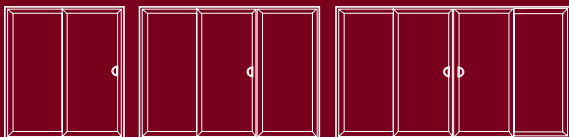

2-Lite

3-Lite

4-Lite



2-Lite

w/Transom

2-Lite

w/Elliptical

2-Lite

w/Half-round

NEW Door Handle Options



Our new patio door handles will be used to replace our existing "D-Handle". These patio door handles feature a more-modern look, a two-point locking system and are comprised of heavy-duty components to assure positive locking. The robust squared handle enhances the overall finish of the door with its sleek lines and ergonomic design. These handles contain the same punch settings as the D-Handle and can easily replace the existing handle if needed. The new locks may be either keyed or non-keyed.



Patio Doors

The abundance of light and the feeling of inclusiveness created by large panes of glass makes any home feel more airy and look brighter. Vivinco's patio doors slide open smoothly to allow for easy indoor/outdoor access.

Patio Door Customization

- 2-Lite, 3-lite, and 4-lite patio doors come standard with a vinyl sill
- Grid patterns include colonial and prairie, in flat or deluxe styles. SDLs also available
- Knock down assembly option available for 2-lite, 3-lite, and 4-lite patio doors
- Blinds between glass available on select sizes for 2-lite, 3-lite, and 4-lite patio doors

Patio doors are available with all of our color options. See pages 27-33 for option details

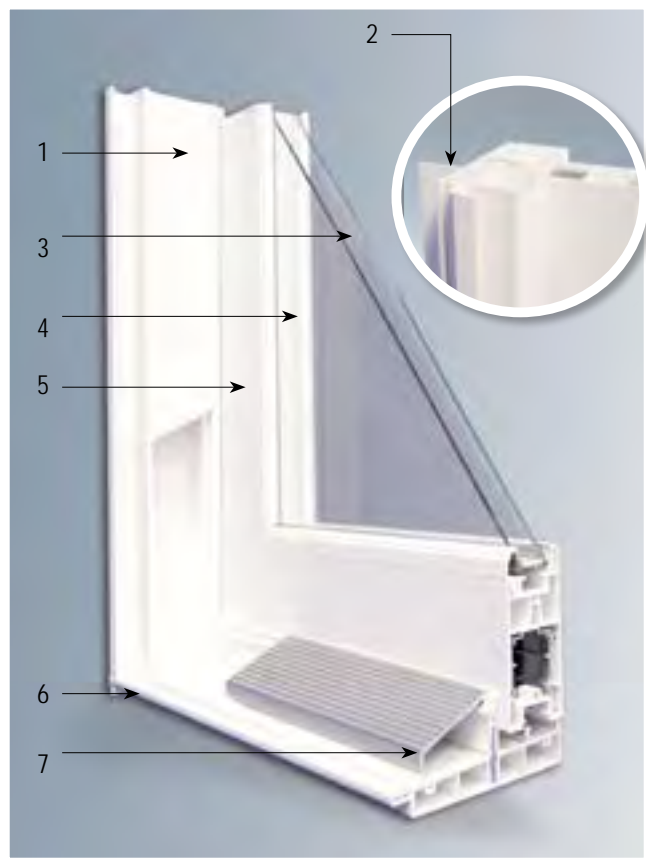

Patio Door Features

1. Head and jamb track covers for a finished appearance
2. Snap-in J-channel accessory is available to allow for a 3/4" or a 1-1/4" J-channel pocket for siding with a brick mold look on the exterior
3. 1" Tempered, double-strength, Low-E glass, thermally efficient spacer, and argon gas fill for strength and thermal efficiency
4. Extruded glazing bead is mitered in the corners for a hand-crafted look
5. Precision-cut and fusion-welded frame creates a powerfully-built sliding patio door. 4" stiles and a slim frame maximize the viewing area
6. Independent screen track keeps screen in place during travel
7. Threshold cover keeps out dirt, grass and leaves

Patio Door Handing Options

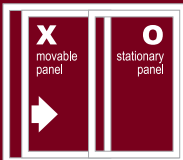

Left-Hand Operation
Viewed from outside

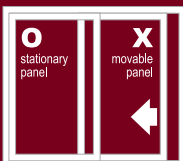

Right-Hand Operation
Viewed from outside

2-Panel patio door with Blink Blinds - blinds between the glass.

Options for every project.

Unparalleled quality. Viwinco provides it not only in our windows, but also in the details you choose to customize them. We have the options you're looking for, and maybe even some that will surprise you.

Product Line Option Availability

Product Line	Structurally Mullled Units	Solid Extrusions	Exterior Laminates	Grids/Simulated Divided Lites	Specialty Glass	Brushed Nickel Hardware	Screens
CAMBRIGE	✓ (see p. 15)	✓	✓	✓	✓	✓	✓
EDGEMONT	--	White/Tan (see p. 29)	--	Grids (see p. 31)	✓	--	✓

Staying true to the home's centuries-old architecture was extremely important to the homeowner of this historic saltbox home—one of the first buildings in the town of Vienna, Maryland. This presented a challenge, especially because the owner had another priority, too: low-maintenance, energy efficient windows that would last. The simple elegance of Cambridge white double-hungs fit the bill. They feature simulated divided lites in a colonial pattern to recreate the traditional appearance of small panes of glass.



AFTER



Colors

Windows and doors are one of the most eye-catching aspects of a home, and adding color is one of the easiest ways to add personality. Viwinco's exterior laminates do more than bring character to your home, however, they are the most robust and enduring you can find. Engineered to outperform some of the harshest conditions, our exterior laminates are proven to withstand the test of time while maintaining the bold colors you want. Did we mention our laminates also provide exceptional thermal performance? Our premium laminates are comprised of multiple thin layers that result in a finish that is highly resistant to harmful ultraviolet light and salty air (ideal for coastal applications). Durable, efficient, and bold, our exterior colored laminates are the perfect solution to adding personalization to any project.

Traditional Solid Extrusions:



White



Tan



Clay

Cambridge:
White, Tan, or Clay.
Edgemont:
White or Tan only.

VIWINCO COLORS Available with white interior only

Available on Cambridge windows



Bronze



Midnight Black

- ▶ Triple-layer construction for exceptional durability
- ▶ More robust than paint: won't chip, crack, or fade
- ▶ Heat-reflective technology
- ▶ Impervious to the damaging effects of moisture and salt; ideal for coastal regions

Viwinco Casement/casement/casement unit with colonial grid pattern and a single casement window with diamond grid pattern.

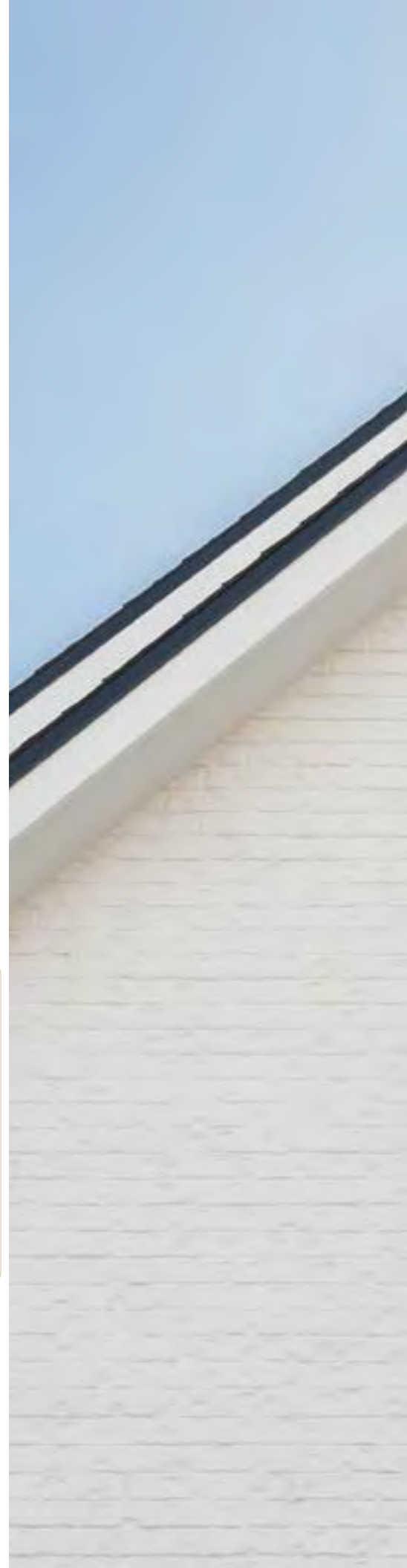





Above: Cambridge Casement/Casement Picture/Casement with simulated divided lites, exterior view.

Inset: Close-up exterior view of simulated divided lites.

Simulated Divided Lites (SDLs)

Only available on Cambridge windows.

Achieve the classic look of authentic divided lites while enhancing your window's energy efficiency.

- Great for historic restorations
- Permanently adhere to the inside and outside of the glass
- Offered in all of our solid extrusions, and exterior colors



Simulated Divided Lites and Deluxe Grids may be laminated to match your window. Shown above in Midnight Black and white.

Grids

Grids add definition to your window, dimension to a room, and character to your home. Sealed between the glass for easy cleaning, they are available in two styles—flat internal or deluxe internal.

Windows with an exterior laminate are available with color-matched deluxe grids or simulated divided lites.



Deluxe top, Standard bottom

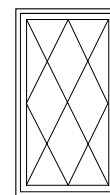

Diamond

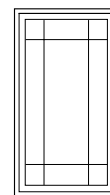

Prairie

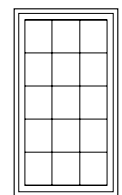

Colonial

Patterns:

Colonial, Prairie, Double Prairie, Diamond (flat internal only), Queen Anne, Valance, or specialty designs.

Note: Option availability depends upon product line.



Above: Obscure glass provides privacy and lets in natural light, making it the ideal choice for this steamroom. A twin casement with stainless steel hardware.

Specialty Glass

Glazing options include gray tint or obscure glass.

Gray tint reduces solar heat gain and obscure glass increases privacy.



Gray-tinted



Obscure glass



Above: Tilt-*n*-Lock Hardware gives you the ability to open, tilt and lock your window all with one hand while keeping your sight lines clean and free of tilt latches.

Hardware Finishes

Your hardware finish will automatically match the interior color of your window. **Brushed nickel hardware is also available as an option** for any Cambridge window or patio door with a solid extrusion or exterior laminate.

Cambridge Tilt-*n*-Lock hardware

Tilt-*n*-Lock provides a clean, uncluttered view. By eliminating tilt latches we've rid the window of unnecessary crevices that attract dust. The one-handed system allows you to tilt the window in with one hand and hold your cleaning supplies in the other. When you're done cleaning, simply push the window shut; there are no tilt latches to re-engage.



Available in white, tan, clay, and brushed nickel. For more pictures of the different finishes visit our website at www.Viwinco.com.

Casement Hardware

All casements and awnings come standard with stainless steel hardware for added strength and durability as well as our new modern handle and lock for a sleek finished look.



Window Operating Control Device Locks

We offer window operating control devices (WOCD) when required by code on our hung and casement products.



WOCDs for single- and double-hung windows



WOCDs for casement windows



Above: Cambridge double-hung windows in bronze exterior laminate and color-matched extruded full-screens.

Screens

Viwinco windows have two available screen options, extruded locking half-screen and extruded full screens. BetterVue® screening is standard on both screen options.

Extruded Locking Half-Screen: Locking screens can be securely locked in the up or down position. Only available on Cambridge.

Extruded Screens: Durable aluminum construction that's resilient, resistant to rust and won't warp or bow. Built to last the life of your window. Pull rails are located on all four sides, there are no pull tabs to obscure the view.

Cambridge windows come *standard* with our heavy-duty extruded locking half-screen and **Edgemont** windows come *standard* with an extruded half-screen. **Full extruded screens** are available as an *upgrade* for both **Cambridge** and **Edgemont** windows.



Heavy-duty extruded locking half-screen.

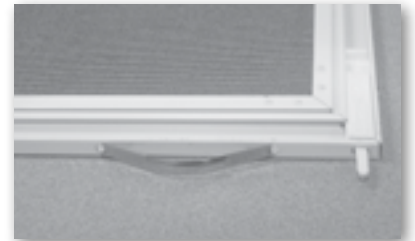

Extruded full-screen with reinforced corners.





Joined together in a continuous mainframe, this casement/casement picture unit features an eye-catching design and maximized viewing area.

Your home is a part of you. The comfort and beauty you create inside and outside reflect the life you are building for yourself and your family. Perhaps nothing is more important to your home's atmosphere than your windows. They provide light, air, character, warmth—as well as the views that connect you to your surroundings. For more than thirty-five years, homeowners have counted on Viwinco's custom-made replacement windows to provide benefits ranging from top energy efficiency to curb appeal. Over those same thirty-five years, our family-owned and operated business has grown into one of the most innovative and trusted in the industry.

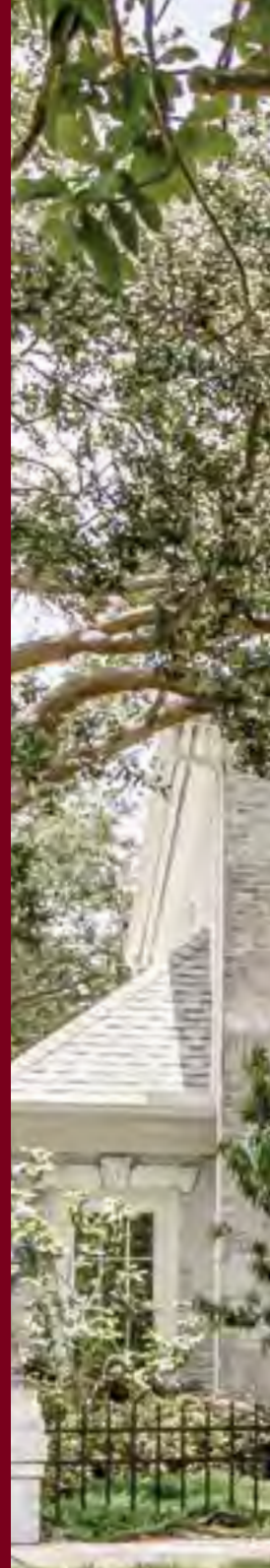

851 Hemlock Road · Morgantown, PA 19543
610-286-8884 | www.Viwinco.com



REP100 Updated © 2/2022 Viwinco Inc.

