



COMMERCIAL DOORS

REEB[®] IN-STOCK COMMERCIAL CATALOG



Introduction



Do you need a Fire-Rated Door?

When considering a fire door, it is crucial to determine if the door is for a Commercial or Residential application. Both applications require different doors, and it is vital to choose the correct one for your needs. Reeb stocks a wide variety of hollow metal doors, flush wood doors, and frames from the industry's top manufacturers.

Typical Reeb commercial projects include:

- Doctor's offices
- Banks
- Churches
- Small office buildings
- Small hotels
- Strip mall receiving doors
- And more...

Table of Contents

Introduction	2
How to Choose A Commercial Door	3
Understanding Fire Ratings	4
Hollow Metal Doors	6
Commercial Flush Wood Doors	8
Lites & Louvers	10
Frames	12-16
Masonry Frame.....	12
Drywall Frame	14
Commercial Split Steel Frame.....	16
Hardware and Accessories	18-22
Heavy Duty Exit Devices.....	18
Standard Duty Exit Devices	19
Closers, Hinges and Locks	20
Additional Accessories.....	22
SteelCraft Specifications?	24
Delivery Details	24
Neutral and Positive Pressure	25
Handing	26
Education Tools	27

How To Choose A Commercial Door

STEP 1

Determine if a fire rating is required

Laws and regulations regarding fire ratings can vary between states, cities, townships, and municipalities. Always be sure to check all regulating authorities to ensure the door units you order and install will comply with applicable laws.

STEP 2

Choose a door

After determining what fire rating is needed, the next step is choosing a door. Reeb® stocks two types of commercial doors: hollow metal and commercial flush wood. Other residential stile and rail and molded doors are available on request.

STEP 3

Choose a frame

To choose the correct frame type, determine if your wall construction is drywall or masonry. If drywall, we stock two types of steel frames: hollow metal and commercial split steel. Masonry frames are hollow metal.



STEP 4

Choose your lites and louvers

Reeb stocks a variety of lites and louvers for the most common applications. All lites and louvers can be installed in hollow metal and wood doors, just select your preferred shape, size and position.

STEP 5

Select your hardware and accessories

Reeb offers an extensive line-up of commercial hardware including exit devices, closers, locks and more.

Fire Ratings



Fire doors and their respective frames and hardware are rated by the amount of time, in minutes or hours, that a door can withstand fire in test conditions.

Laws and regulations can vary widely between states, cities, townships and municipalities. Always be sure to check with all regulating authorities to ensure the door units you order and install comply with all applicable laws.

Reeb's commercial doors are stocked as Category "B" doors meaning they do not have a built-in system to comply with the positive pressure requirements. Therefore, all commercial doors are neutral pressure rated. Reeb can offer the Hollow Metal doors as positive pressure rated by supplying an intumescent strip that must be applied after installation and finishing. An architectural wood flush commercial door must be special ordered to have a positive pressure rating.

For more information on neutral and positive pressure rated doors please see page 25.

For additional information on Fire Ratings please visit learn.reeb.com

Intumescent strip applied to hollow metal frame by the installer in the field

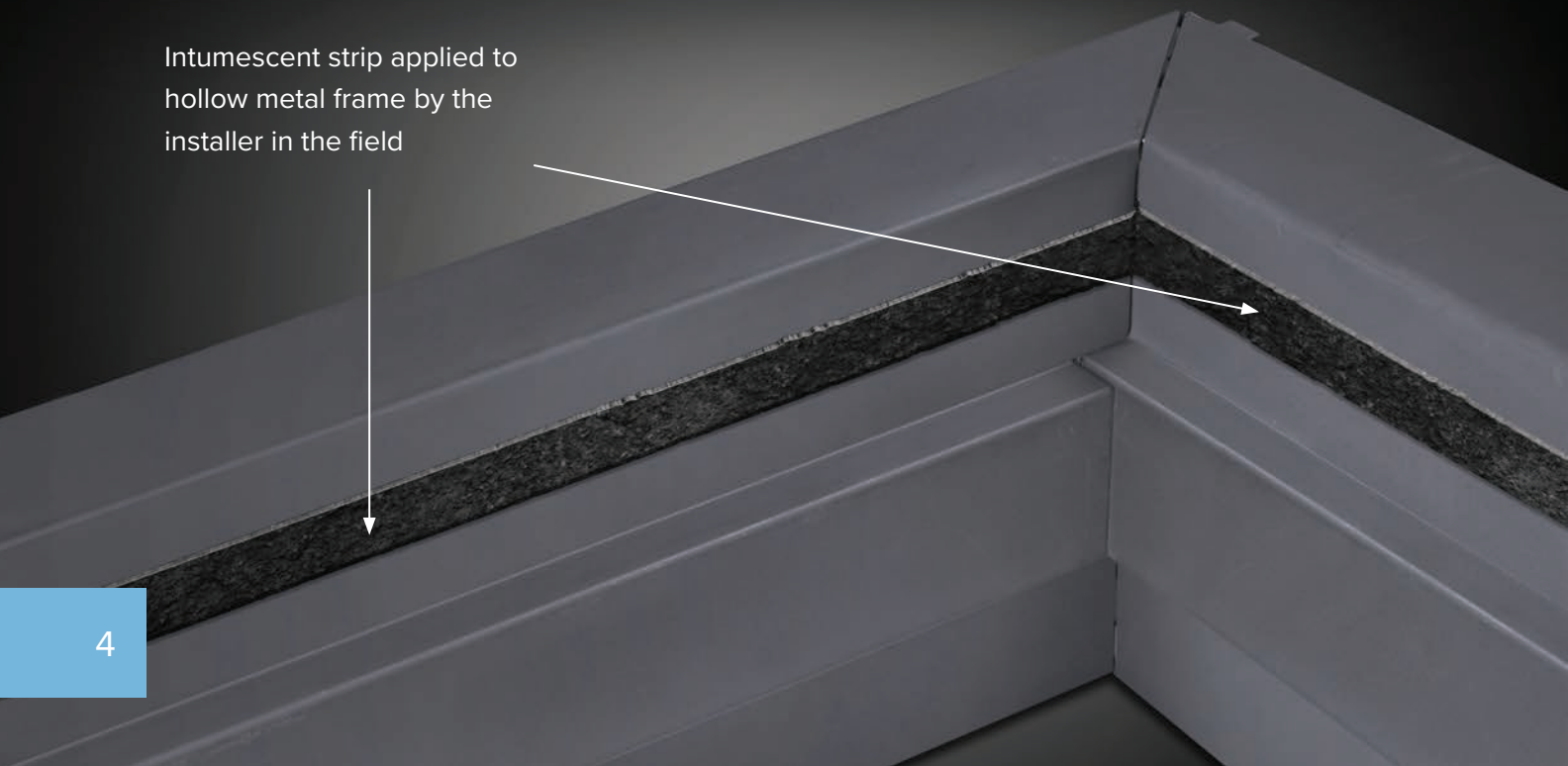



The following is a list of basic fire door requirements. This list may not encompass all requirements so make sure to check your local building codes.

1. The unit must be self-closing.
2. The unit must be self-latching.
3. The unit must have a Label attached.
4. The Door Frame must have an attached or embossed Label.
5. The unit must have Steel Bearing Hinges.
6. The unit must have "Listed" Hardware.
7. If a Fire Door is held open, it must have a "UL-Listed", heat fusible link or smoke detection device (or be tied into the fire alarm system).
8. A maximum of 1296 square inches of visible glass is allowed to achieve a 20 or 45 minute rating.
9. The maximum glass allowed in a 60- or 90-minute rated door is a 100 sq. in. per lite.
10. A Fire Door with a Louver requires a Fusible Link Louver.
11. No Louvers are allowed in fire-rated doors with lite kits.
12. No Louvers are allowed in doors with Panic Exit Hardware or Stairwells.
13. The maximum Fire-Rated louver size is 24" x 24".

Hollow Metal Doors

Reeb Hollow Metal Doors are constructed from 18-gauge galvanized steel with a polystyrene core and can be fire-rated for up to 90 minutes. These doors are factory machined to SteelCraft hinge and strike locations and can be prepped with either a single bore or with a RIM reinforced option.



HM 2 Panel



HM 6 Panel

Features

- 18-Gauge Galvanized Steel
- Reinforced for closer
- Undersized 1/4" in width and 5/8" in height
- Fire Rated up to 90 minutes
- Square Edges
- 161 Prep: 2-1/8" x 2-3/4" backset
- Extremely durable and easy to paint
- RIM Reinforced for Panic Hardware
- Polystyrene insulated core
- 4-1/2" Square Corner Hinge prep

Lites or Louvers can be installed in these doors and still maintain a fire rating depending on the glass or louver installed. The following layouts are available.

See page 10 for more information.

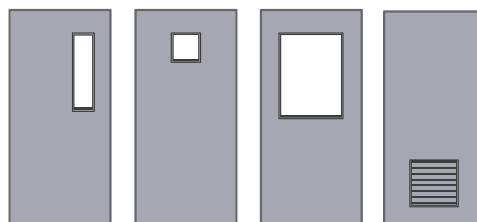

Hollow Metal Doors



Sizes	HM Flush		HM 2 Panel		HM 6 Panel	
	161 Bore	Rim Reinforced	161 Bore	Rim Reinforced	161 Bore	Rim Reinforced
2/0 x 6/8	X	X				
2/6 x 6/8	X	X				
2/8 x 6/8	X					
2/10 x 6/8	X	X				
3/0 x 6/8	X	X	X	X	X	X
3/6 x 6/8	X	X				
3/8 x 6/8		X				
4/0 x 6/8	X					
5/0 x 6/8	X/O	X/X				
6/0 x 6/8	X/O	X/X	X/O	X/X	X/O	X/X
2/0 x 7/0	X	X				
2/6 x 7/0	X	X				
2/8 x 7/0	X					
2/10 x 7/0	X	X				
3/0 x 7/0	X	X	X	X	X	X
3/6 x 7/0	X	X				
3/8 x 7/0		X				
4/0 x 7/0	X					
5/0 x 7/0	X/O	X/X				
6/0 x 7/0	X/O	XX	X/O	X/X	X/O	X/X

X = Stock Single Door
 X/O = Stock Double Door with Flushbolt Prep
 X/X = Stock Double Door for use with Vertical Rod Panic Hardware

Commercial Flush Wood Doors

Reeb® stocks commercial flush wood door products in two species - **Birch** and **Oak**. Each door is 1-3/4" thick with a choice of 20 minute (particle core) or 90 minute (Mineral core).



Unfinished Birch

Finished Birch



Unfinished Oak

Finished Oak

Features

- Prefit 3/16" in width and 3/4" in height with a Beveled Edge
- Specifically designed for Hollow Metal frames
- Will not work in Reeb's Standard Exterior Frame
- Shop can prep for Hinges, Bore, Flushbolts and ASA Strikes
- Machined to standard SteelCraft Specifications
- Custom Hinge and Bore locations available upon request and specification
- Extremely durable and easy to paint/stain
- Fire-Rated 90 minute double door needs metal edges installed

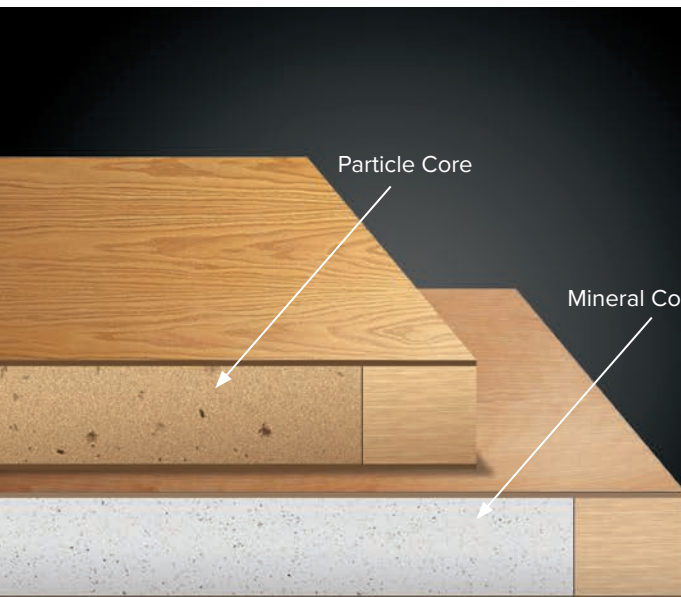

Particle Core

- 5 Ply Particle Core Birch / Oak Doors
- ASTM D5456-09 / ANSI A208.1
- Stiles = 7/16" Wood laminated to 1" SCL
- Rails = 1-7/16" SCL
- Core = Particleboard with density of 28-32 PCF LD1 Bonded
- Adhesive = Type I (waterproof) PVA (no urea formaldehyde) VOC<0.683 g/L

Mineral Core

- 5 Ply Fire-Rated Core Birch / Oak Doors
- Stiles = 7/16" Wood laminated to 1" (FPCM) (Fire Proof Composite Material)
- Rails = 1-1/2" (FPCM)
- Core = Non-Combustible Material
- Adhesive = Type I (waterproof) PVA (no urea formaldehyde) VOC<0.683 g/L

Commercial Flush Wood Doors

In-Stock Sizes

Birch

Natural Rotary
Stain Grade



Birch

Natural Rotary
Prefinished Clear

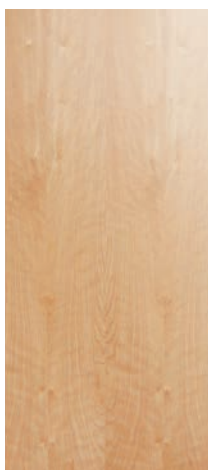

Red Oak

Plain-Sliced
Stain Grade



Red Oak

Plain-Sliced
Prefinished Clear

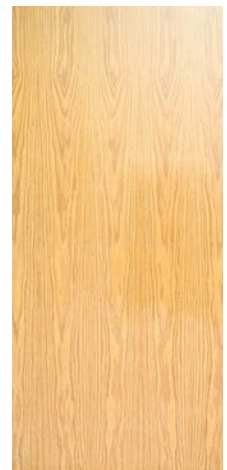

Sizes	20 Min.	90 Min.	20 Min.	90 Min.	20 Min.	90 Min.	20 Min.	90 Min.
2/0 x 6/8	X							
2/6 x 6/8	X	X	X					
2/8 x 6/8	X	X						
3/0 x 6/8	X	X	X	X	X	X	X	X
3/6 x 6/8	X	X						
5/0 x 6/8	X/O & X/X	X/O	X/O & X/X					
6/0 x 6/8	X/O & X/X	X/O & X/X	X/O & X/X	X/O & X/X	X/O & X/X	X/O & X/X	X/O & X/X	X/O & X/X
2/0 x 7/0	X							
2/6 x 7/0	X	X	X					
2/8 x 7/0	X	X						
3/0 x 7/0	X	X	X	X	X	X	X	X
3/6 x 7/0	X	X						
4/0 x 7/0	X							
5/0 x 7/0	X/O & X/X	X/O	X/O & X/X					
6/0 x 7/0	X/O & X/X	X/O & X/X	X/O & X/X	X/O & X/X	X/O & X/X	X/O & X/X	X/O & X/X	X/O & X/X

Lites or Louvers can be installed in these doors and still maintain a fire rating depending on the glass or louver installed. The following layouts are available. See page 10 for more information.

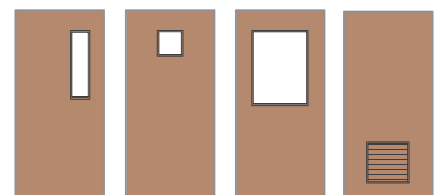

Lites

Adding a lite, or piece of glass, to a door is often wanted and the same can be said for commercial doors. The order size is the opening that is found in the door. Into this opening, the entire lite frame system is installed. The visible lite size, or exposed glass size, is 2" smaller than the order size.



Safe-Wire Fire Glass is able to hold a fire rating. It has a 3/4" x 3/4" diamond pattern that maintains integrity when fractured or subjected to a hose stream.



Pyran F Clear Glass is able to hold a fire rating. The fire rating of the door though relies on the size of the glass that is visible. Pyran F glass is a heavy duty 7 mil durable safety film with neutral coloration.



Clear Tempered Glass will hold no fire rating. Therefore, the size of the glass does not matter in relation to a fire rating. Tempered glass is a type of safety glass with increased strength compared with normal glass.

Adding a lite over 100 square inches to a fire-rated door though will decrease its rating by 50%. The overall unit can only be rated to the lowest rating possible.

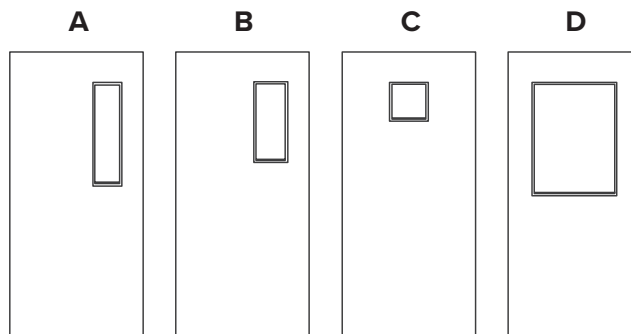

	Order Size	Exposed Glass Size	Safe-Wire Glass		Pyran F Glass		Clear Tempered Glass
			90 Min.	20 Min.	90 Min.	20 Min.	
A	6" x 27"	4" X 25"	Up to 90 Mins.	Up to 20 mins.	Up to 90 Mins.	Up to 20 mins.	Non-Rated
B	7" x 22"	5" X 20"	Up to 90 Mins.	Up to 20 mins.	Up to 90 Mins.	Up to 20 mins.	Non-Rated
C	12" x 12"	10" X 10"	Up to 90 Mins.	Up to 20 mins.	Up to 90 Mins.	Up to 20 mins.	Non-Rated
D	24" X 30"	22" X 28"	Up to 45 Mins.	Up to 20 mins.	Special Order	Special Order	Non-Rated

Louvers

Louvers provide ventilation when inserted into a hollow metal or architectural wood door. Due to their ventilation capabilities, louvers should only be installed in a door with a fire rating higher than 20 minutes.



AFDL (Fixed Blade Door Louver) louvers are fixed louvers to allow for ventilation but do not have any additional function, meaning they cannot withstand any fire scenario.

FLDL (Fusable Link Door Louver) louvers are louvers with slats to allow for standard louver functionality. When temperatures increase in a fire room, the slats slowly become vertical and interlock in place, making a flush door with a louver, turn into a flush door. Preventing the fire from spreading for 90 minutes when installed in the correct door slab.

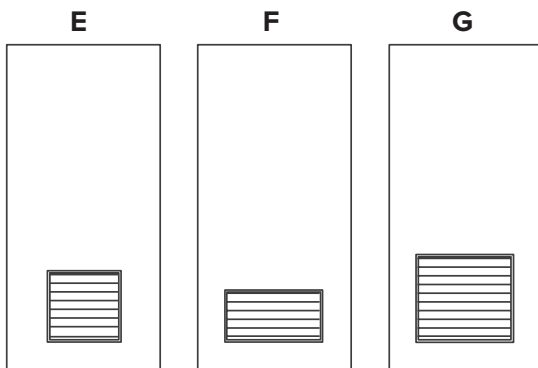

Order Size		AFDL Non-Rated	FLDL Rated Up To 90 mins
E	18" x 18"	X	
F	24" x 12"	X	
G	24" x 24"	X	X

AFDL = Fixed Blade Door Louver
 FLDL = Fusable Link Door Louver
 X = STOCK ITEMS

Masonry Frame

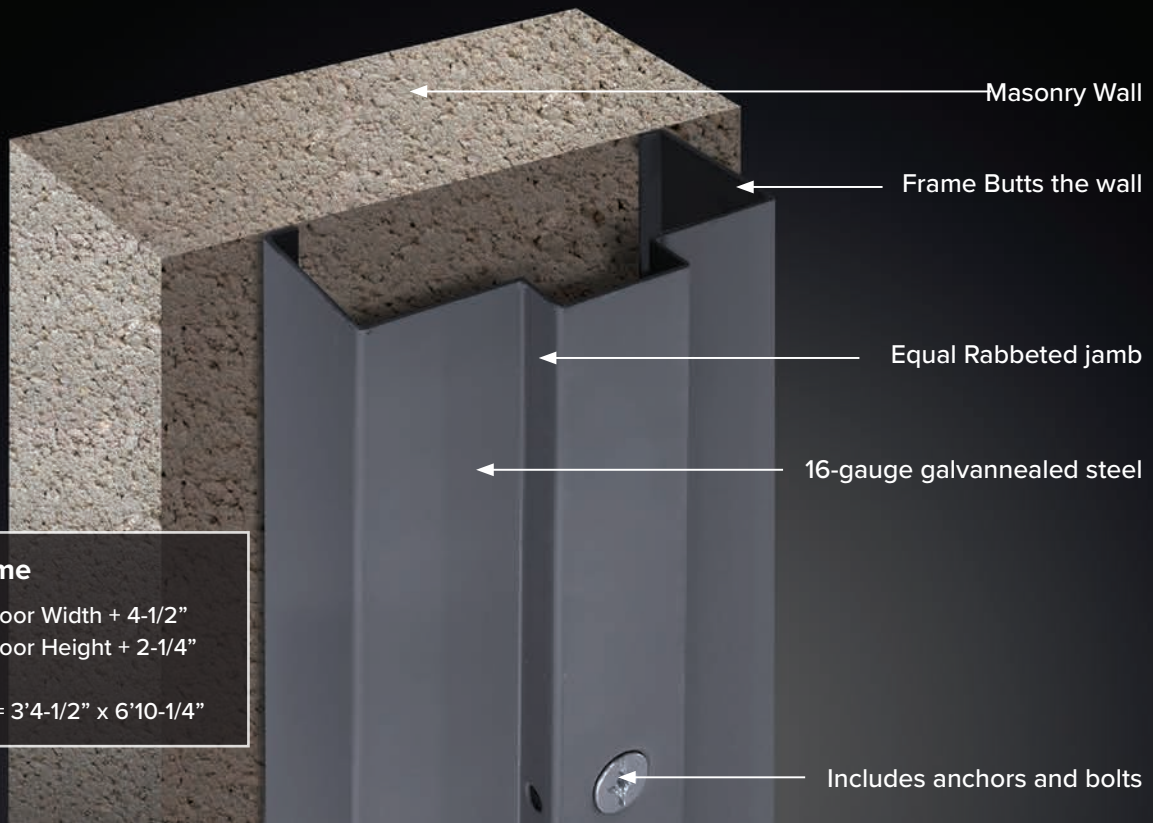

Masonry Frame

R.O = Nominal Door Width + 4-1/2"

R.O = Nominal Door Height + 2-1/4"

Example:

3'0" x 6'8" R.O. = 3'4-1/2" x 6'10-1/4"

A masonry frame application requires some sort of masonry. Masonry consists of tile, stone, brick or concrete. With this type of frame the masonry wall is deeper than the frame material, the proper application for installation of the frame is to have the frame installed flush against the wall.

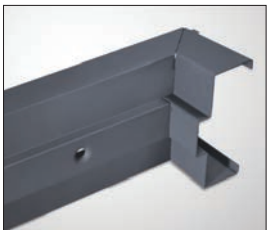

3 Piece Knock Down Frame



Door Silencers

Features

- 16-Gauge Galvanized
- Primed and ready to paint
- Frames are stocked as 5-3/4"
- Installed using anchor bolts to hold frame in place
- Reinforced for door closer
- Hinge preps allow for the use of standard or heavy duty commercial hinges
- Fire-rated up to 90 minutes
- Punched and dimpled frame prep with anchors and bolts
- **Frames are shipped knocked down and bundled together with hardware, doors and other accessories**

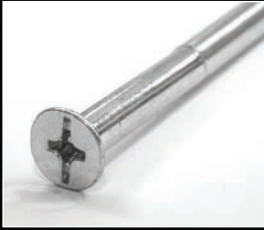

Dynabolt



Dimple and Counter Sink

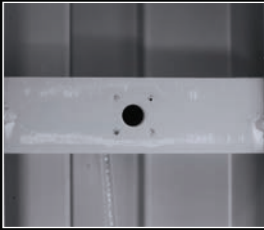

Welded pipe anchor for Reinforcement

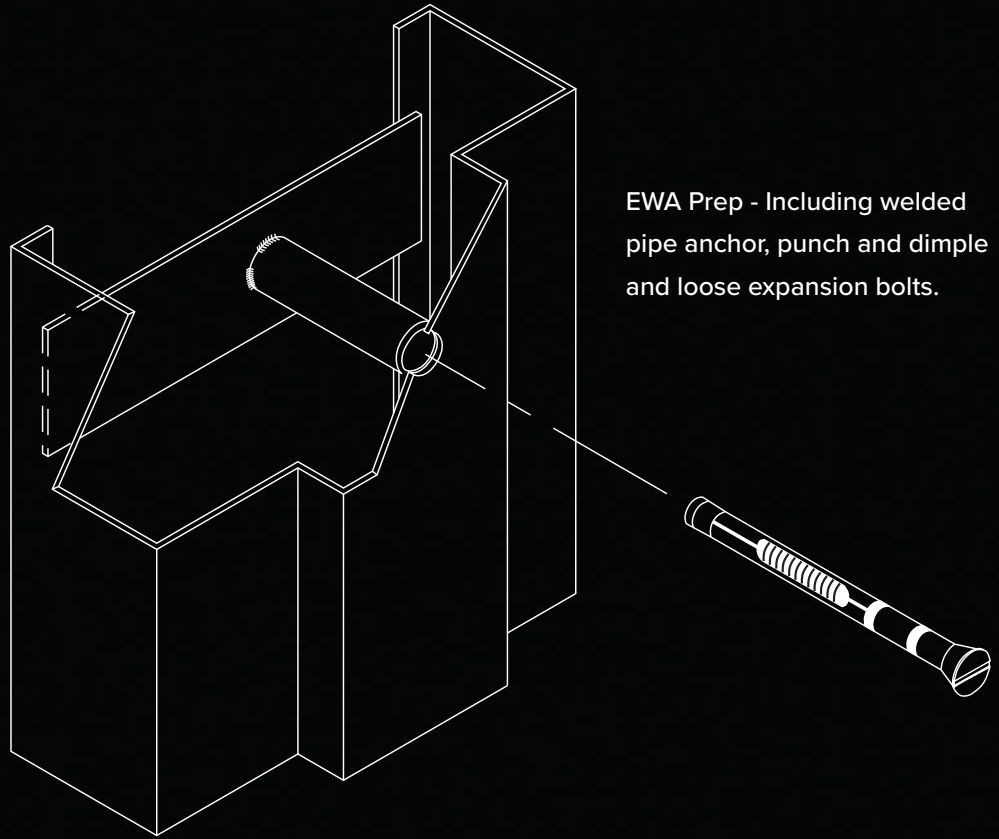

EWA Prep - Including welded pipe anchor, punch and dimple and loose expansion bolts.

Hardware sold separately. Please specify if needed.



ASA Strike Plate (ASA)



Panic Reinforcement (Panic)



Flushbolt Prep (F/B)

Single Doors

In-Stock Sizes	5-3/4" ASA	5-3/4" Panic
2/6 x 6/8	X	
2/8 x 6/8	X	
2/10 x 6/8	X	X
3/0 x 6/8	X	X
3/6 x 6/8	X	X
3/8 x 6/8		X
4/0 x 6/8	X	
2/6 x 7/0	X	
2/8 x 7/0	X	
2/10 x 7/0	X	X
3/0 x 7/0	X	X
3/6 x 7/0	X	X
3/8 x 7/0		X
4/0 x 7/0	X	

Double Doors

In-Stock Sizes	5-3/4" F/B	5-3/4" Panic
4/0 x 6/8	X/O	X/X
5/0 x 6/8	X/O	X/X
6/0 x 6/8	X/O	X/X
4/0 x 7/0	X/O	X/X
5/0 x 7/0	X/O	X/X
6/0 x 7/0	X/O	X/X

Note: All Hollow Metal frames are stocked with Closer Reinforcements. See page 25 for more details.

X = Stock Single Door
 X/O = Stock Double Door with Flushbolt Prep
 X/X = Stock Double Door for use with Vertical Rod Panic Hardware

Drywall Frame

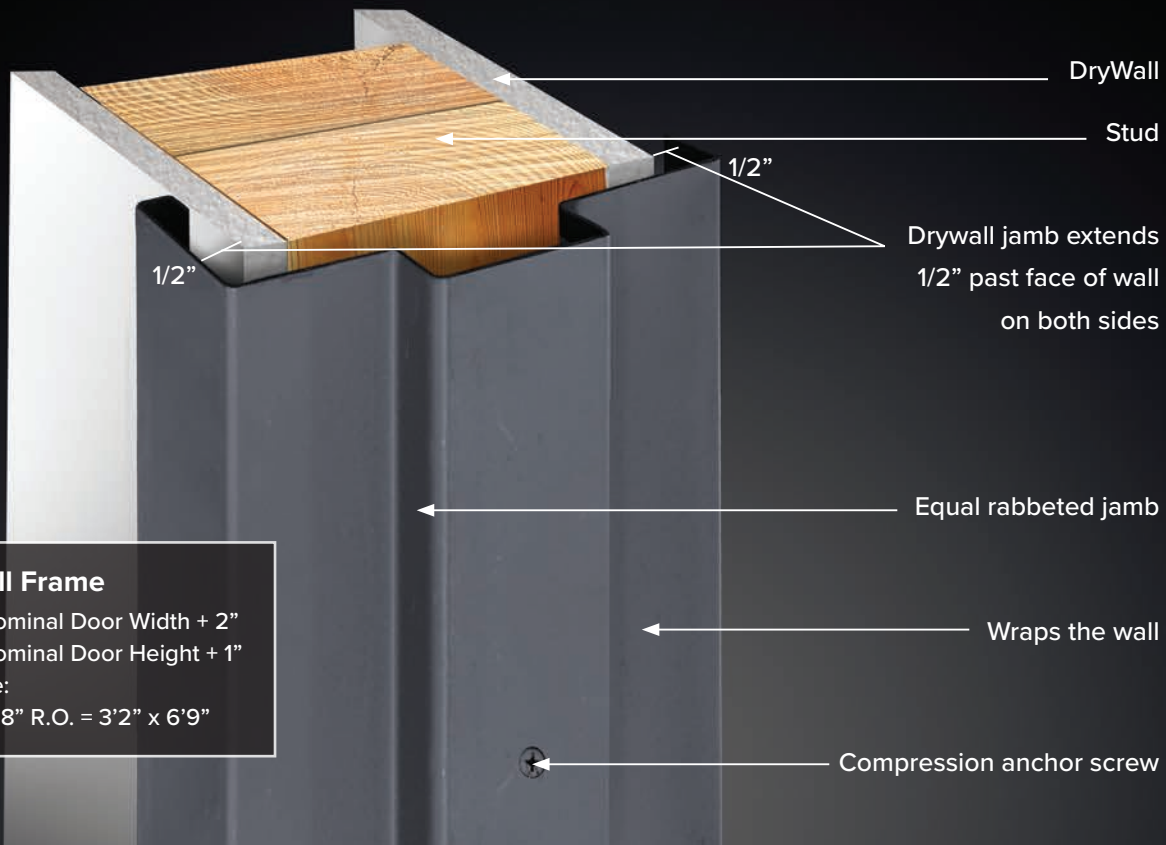

Drywall Frame
 R.O = Nominal Door Width + 2"
 R.O = Nominal Door Height + 1"
 Example:
 3'0" x 6'8" R.O. = 3'2" x 6'9"

A drywall frame application requires studs covered by drywall or sheetrock. With this type of application the frame wraps around the wall. The wall is known as the jamb size, and where the wall is being wrapped is the throat of the hollow metal frame.

Features

- 16-Gauge CRS (Cold Rolled Steel)
- Primed and ready to paint
- Reinforced for door closer
- SteelCraft hinge and strike specifications
- Hinge preps allow for the use of standard or heavy duty hinges
- Fire-Rated up to 90 minutes
- Compression anchors are used to lock the frame against the 2x4
- Sill Straps are used at the bottom of the frame to secure to the drywall
- **Frames are shipped knocked down and bundled together with hardware, doors and other accessories**

For Adjustment & Installation

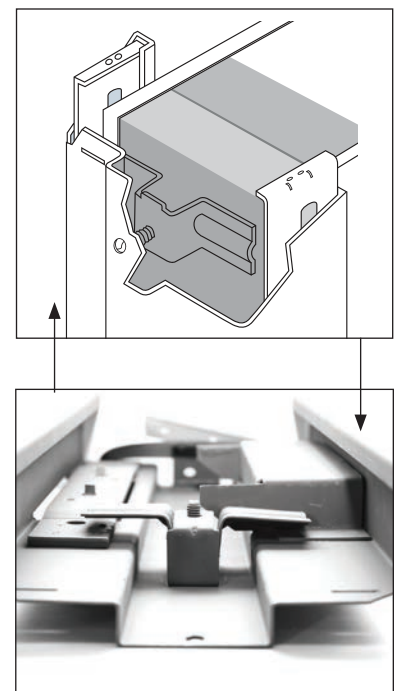

Compression Anchor



3 Piece Knock Down Frame



Compression Anchor Screw



Door Silencers

For Installation

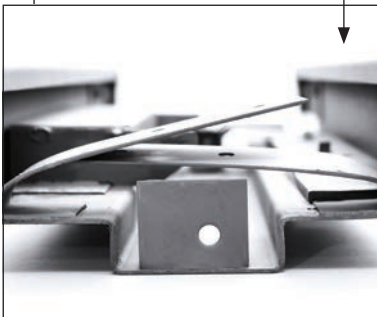
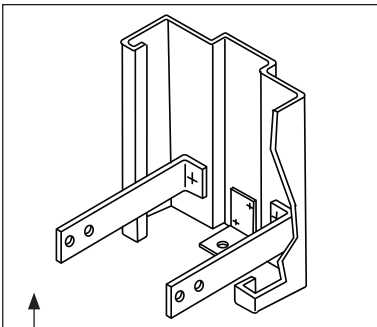

Sill Straps

Hardware sold separately. Please specify if needed.



ASA Strike Plate (ASA)



Panic Reinforcement (Panic)

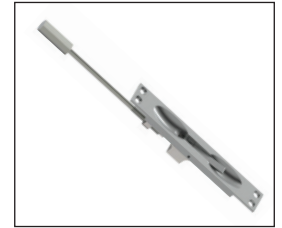

Flushbolt Prep (F/B)

Single Doors

In-Stock Sizes

Frame Depth	5-5/8" ASA	5-5/8" Panic	5-7/8" ASA	5-7/8" Panic	7-3/4" ASA	7-3/4" Panic
Wall Thickness	4-5/8"	4-5/8"	4-7/8"	4-7/8"	6-3/4"	6-3/4"
2/0 x 6/8	X		X		X	
2/6 x 6/8	X		X		X	
2/8 x 6/8	X		X		X	
2/10 x 6/8	X	X	X	X	X	X
3/0 x 6/8	X	X	X	X	X	X
3/6 x 6/8	X	X	X	X	X	X
3/8 x 6/8		X		X		X
4/0 x 6/8	X		X		X	
2/0 x 7/0	X		X		X	
2/6 x 7/0	X		X		X	
2/8 x 7/0	X		X		X	
2/10 x 7/0	X	X	X	X	X	X
3/0 x 7/0	X	X	X	X	X	X
3/6 x 7/0	X	X	X	X	X	X
3/8 x 7/0		X		X		X
4/0 x 7/0	X		X		X	

Double Doors

In-Stock Sizes

Frame Depth	5-5/8" F/B	5-5/8" Panic	5-7/8" F/B	5-7/8" Panic	7-3/4" F/B	7-3/4" Panic
Wall Thickness	4-5/8"	4-5/8"	4-7/8"	4-7/8"	6-3/4"	6-3/4"
4/0 x 6/8	X/O	X/X	X/O	X/X	X/O	X/X
5/0 x 6/8	X/O	X/X	X/O	X/X	X/O	X/X
6/0 x 6/8	X/O	X/X	X/O	X/X	X/O	X/X
4/0 x 7/0	X/O	X/X	X/O	X/X	X/O	X/X
5/0 x 7/0	X/O	X/X	X/O	X/X	X/O	X/X
6/0 x 7/0	X/O	X/X	X/O	X/X	X/O	X/X

X = Stock Single Door
 X/O = Stock Double Door with Flushbolt Prep
 X/X = Stock Double Door for use with Vertical Rod Panic Hardware

Commercial Split Steel Frame

INTERIOR USE ONLY

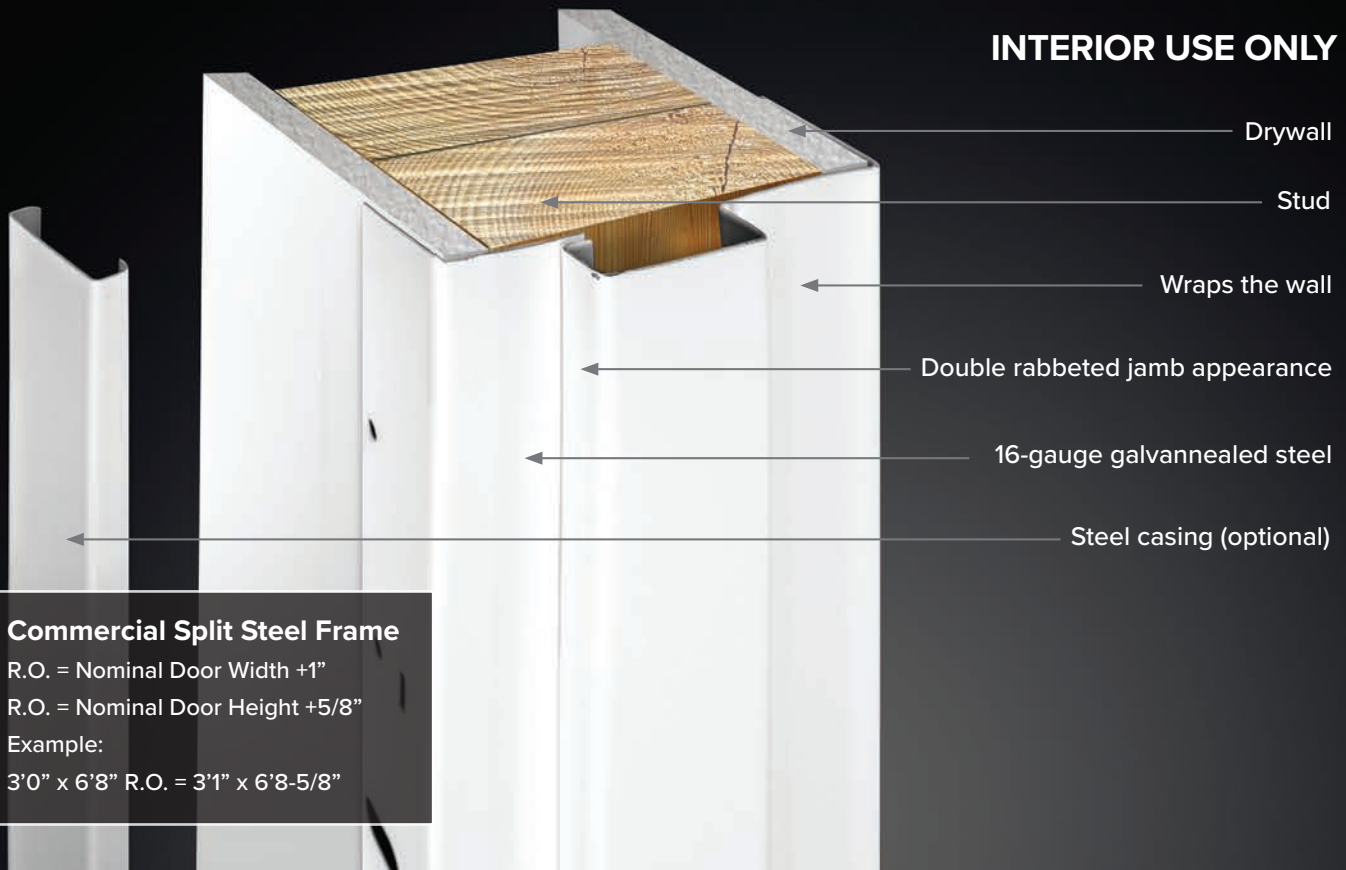

Commercial split-steel frames are also an excellent choice for security, fire safety, sound reduction and sanitation in high-traffic commercial buildings. Unlike hollow metal frames, commercial split-steel frame's multipart construction allows for adjustments when the exact wall thickness cannot be determined. Reeb® stocks commercial split-steel frames for interior use only.

Features

- Cold-rolled 16-gauge Powder-Coated Galvanized Steel
- Easy to paint but come pre-finished
- 18-gauge closure package for adjustments in the field.
- Prepped for 4-1/2" hinges and an ASA ANSI Strike, both to SteelCraft specifications
- No deadbolt prep available
- Intended to be an Interior Frame and should only be used in this application
- **Frames are shipped knocked down and bundled together with hardware, doors and other accessories**



Closure Pack

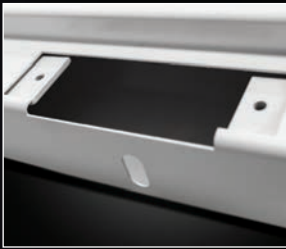

4-7/8" ASA Prep



ASA Plate Adapter



Hinge Reinforcement



Casing (Optional)

Single Doors

In-Stock Sizes

Closure Packs	4" to 5-1/4"	5" to 6-1/4"	6" to 7-1/4"	8" to 9-1/4"
2/6 x 6/8	X	X	X	X
2/8 x 6/8	X	X	X	X
3/0 x 6/8	X	X	X	X
2/6 x 7/0	X	X	X	X
2/8 x 7/0	X	X	X	X
3/0 x 7/0	X	X	X	X

Note: Double Doors are N/A

X = Stock Single Door

Hardware & Accessories

Heavy Duty Exit Devices

Heavy duty hardware is recommended for high traffic areas.

Exit devices are used with doors that are in an exit path and may be commonly referred to as Panic Hardware. Exit devices are necessary when a large number of people may need to exit the building fast.



4500 Series Rim Exit

RIM Devices are used on outswing single swing applications.



4500 Series Vertical Rod

Surface Vertical Rod (SVR) Devices are used on outswing double swing applications, where the hardware will engage with the frame components and an astragal is not desired.



45CE Withnell



45BE Whitnell

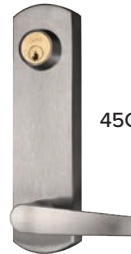

45CE August



45PT Thumbpiece

Heavy Duty Exit Devices	US10B	US26D
Hager® 4500 Series Rim Exit 36"	x	x
Hager 4500 Series Rim Exit 48"		
Hager 4500 Series Fire-Rated Rim Exit 36"	x	x
Hager 4500 Series Fire-Rated Rim Exit 48"		x
Hager 4500 Series Vertical Rod 36" x 84"	x	x
Hager 4500 Series Vertical Rod 36" x 96"	x	x
Hager 4500 Series Fire-Rated Vertical Rod 36" x 84"	x	x
Hager 4500 Series Fire-Rated Vertical Rod 36" x 96"	x	x
Hager 45PT Thumbpiece		x
45CE Withnell Entrance Lever Trim	x	x
45CE August Entrance Lever Trim		x
45NL Withnell Entrance Lever Trim	x	x
45BE Withnell Passage Trim		x
45DT Withnell Dummy Trim	x	x

CE - Cylinder Escutcheon uses a 3902 mortise cylinder which is included. A key is needed to lock or unlock the lever.

NL - Night Latch uses a 3901 rim cylinder which is included. These are always locked and require a key to retract the latch every time.

DT - Dummy Trim. After the level is dogged (or turned) down, you will be able to pull the door open.

BE - Blank Escutcheon. This handleset is always operable and may also be known as a passage lock

Note: shipped loose for field installation.

Standard Duty Exit Devices

Standard duty hardware is recommended for low traffic areas.



Standard Duty Exit Devices	L2	US28
Hager 4700 Series Rim Exit 36" Door	x	x
Hager 4700 Series Rim Exit 48" Door		x
Hager 4700 Series Fire-Rated Rim Exit 36" Door	x	x
Hager 4700 Series Fire-Rated Rim Exit 48" Door		x
Hager 4700 Series Vertical Rod 36" x 84"	x	x
Hager 4700 Series Vertical Rod 36" x 96"	x	x
Hager 4700 Series Fire-Rated Vertical Rod 36" x 84"	x	x
Hager 4700 Series Fire-Rated Vertical Rod 36" x 96"	x	x
47CE Withnell Entrance Lever Trim LHR/RHR	x	x
47CE August Entrance Lever Trim LHR/RHR		x
47NL Withnell Night Latch Lever Trim LHR/RHR	x	x
47DT Withnell Dummy Lever Trim LHR/RHR	x	x
47RN Pull	x	x
47BE Withnell Passage Trim LHR/RHR		x

CE - Cylinder Escutcheon uses a 3902 mortise cylinder which is included. A key is needed to lock or unlock the lever.

NL - Night Latch uses a 3901 rim cylinder which is included. These are always locked and require a key to retract the latch every time.

DT - Dummy Trim. After the level is dogged (or turned) down, you will be able to pull the door open.

RN - Raised Lip Pull Night Latch uses a 3901 rim cylinder which is included. These handlesets are always locked and require a key to retract the latch everytime.

BE - Blank Escutcheon. This handleset is always operable and may also be known as a passage lock

Hardware Finishes

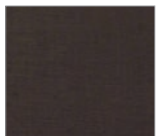

US10B
Oil Rubbed Bronze



US26D
Satin Chrome

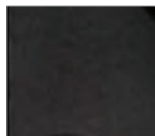

L2
Dark Bronze

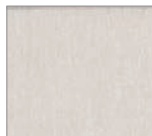

US28
Aluminum

Hardware & Accessories

Closers

A door closer is a mechanical device that closes a door in a controlled manner. It helps prevent the door from standing open, slamming closed, or pulling open in strong winds.

The packaging for this item is a tri-pack meaning it includes the hardware necessary for a Regular Arm, a Parallel Arm, or a Top Jamb Mount Installation.

Door closers with the hold open option are capable of being held in an open position. Many local building codes do not allow the installation of a Hold Open Door Closer in a fire rated system. Please make sure to check with your local building codes.

Closers	L2	US28
5200 Series Medium Duty	x	x
5200 Series Hold Open Medium Duty	x	x
5300 Series Light to Medium Duty	x	x
5300 Series Hold Open Light to Medium Duty		x



5200 Series

Requires minimum top rail clearance of 5-3/4" from top of the door

Note: Closers stocked with Tri-mount Hardware

Hinges	US3	US10B	US15	US26D	US32D
Plain Bearing 4-1/2" x 4-1/2"	x	x	x	x	
Ball Bearing 4-1/2" x 4-1/2"	x	x	x	x	x
Ball Bearing NRP 4-1/2" x 4-1/2"				x	x
Self Closing 4-1/2" x 4-1/2"				x	x



Plain Bearing Commercial



Ball Bearing Commercial



NRP Commercial



Self-Closing Commercial

Plain bearing hinges are only to be used in a non-rated unit.

Ball-bearing hinges are used with rated units that have a door closer.

NRP hinges should be used with outswing units.

Self-closing hinges are used with rated units that do not have a door closer.

Hardware Finishes



US3
Bright Brass

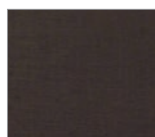

US10B
Oil Rubbed Bronze



US15
Satin Nickel

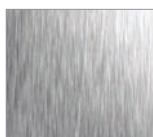

US26D
Satin Chrome



US28
Aluminum



US32D
Stainless Steel



L2
Dark Bronze

Hardware & Accessories

All locks are UL Fire Rated
Note: Locks stocked with ASA Strike Plate

Locks

Withnell 3500 Series

Grade 2 Cylindrical

The 3500 Series lockset is used in a single bore application with a 2-3/4" backset.

This lock is great for high traffic use and is classified as a Grade 2 Cylindrical Lever.

Function	US10B	US26D
3510 Passage	x	x
3540 Privacy	x	x
3553 Entry	x	x
3570 Classroom	x	x
3580 Storeroom	x	x
3517 Dummy	x	x

3500 Withnell

2-3/4" Backset



Withnell 3600 Series

Grade 2 Tubular

The 3600 Series lockset is used in a single bore application and is adjustable to work with either a 2-3/4" or 2-3/8" backset. This lock is great for medium traffic use and is classified as a Grade 2 Tubular Lever.

Function	US10B	US26D
3610 Passage	x	x
3640 Privacy	x	x
3653 Entry	x	x
3680 Storeroom	x	x
3617 Dummy	x	x

3600 Withnell

2-3/8" / 2-3/4" Adjustable Backset



3200 Series

The 3200 Deadbolts are Single Cylinder Deadbolts. A single cylinder requires a key on the exterior but has a thumbturn on the interior.

	US10B	US26D
3215 Single Cylinder	x	x

Deadbolt

Grade 2

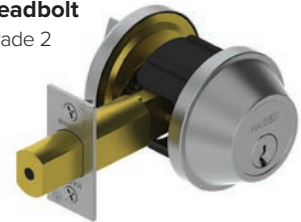

Lock Functions

Function	3600	3500
Passage	Latchbolt operated by lever from either side at all times.	Latchbolt operated by lever from either side at all times.
Privacy	Latchbolt operated by lever from either side. Outside lever is locked by push button and unlocked by emergency release outside, operating inside lever, or closing door.	Latchbolt operated by lever from either side. Outside lever is locked by push button and unlocked by emergency release outside or operating inside lever.
Entry	Deadlocking latchbolt operated by lever from either side. Pushing turn button locks outside lever, unlocked by turning inside lever. Pushing in and turning button locks outside lever, unlocked by manually turning button to unlock. Inside lever always free.	Deadlocking latchbolt operated by lever from either side except when outside lever is locked by push button on the inside. Unlocked by key or by turning inside lever.
Classroom	Deadlocking latchbolt operated by lever from either side except when outside lever is locked from outside by key. When outside lever is locked, latchbolt is operated by inside lever.	Not Stocked
Storeroom	Deadlocking latchbolt operated by key in outside lever or by operating inside lever. Outside lever is always locked. Inside lever is always unlocked.	Deadlocking latchbolt operated by key in outside lever or by operating inside lever. Outside lever is always locked. Inside lever is always unlocked.
Dummy	Pull one side, no mechanical operation.	Pull one side, no mechanical operation.

Additional Accessories

Door Accessories

	US26D	US32D
Wall Stop w/Button Lock	x	
Wall Stop	x	
Floor Dome Stop	x	
Push Plate 4" x 16"	x	
Pull Plate 4" x 16"	x	
Latch Protector Plate		x
	USP	
Strike Plate Filler		x
Frame Filler Plate Lock Edge		x
3-0 Steel Capping Channel - Lockseam		x

Commercial doors may also use some additional accessories including filler plates for the doors or jambs, push or pull plates, and stops or silencers.

Stops are either attached to the door or the floor to help stop the door from opening too far. The choice between a wall or a floor stop come down to the material of the floor and preference. If the floor is made of concrete, then a wall stop may be preferred for easier installation.



Wall Stop Button



Wall Stop



Floor Stop



Push Plate



Pull Plate

Flush Mount Weatherstrip / Astragal Seal

	L2	US28
Meeting Stile Brush Weatherstrip 7' Flush Mount (For Steel and Wood Doors)	x	x
Meeting Stile Brush Weatherstrip 8' Flush Mount	x	x



802S
Flush Mount Weatherstrip

ADA Thresholds

Hollow metal sills are used in commercial applications. They are all ADA approved and therefore are not greater than 1/2" tall. Saddle thresholds are installed in high traffic public areas. They allow easy access for items such as wheel chairs and strollers. The 520S saddle threshold is designed for use with surface mounted vertical rod exit devices. It will provide for a smoother operation of the bottom rod latches.

Brush Sweep

The sweep is attached to the face of the door and seals against air.

	3/0	4/0
801S Brush Sweep	x	x



801S
Door Sweeps

	L2	US28
412S Saddle Threshold 5"	x	x
416S Saddle Threshold 7"		x
520S SVR Saddle Threshold 5"		x

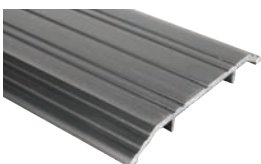

412S
ADA Threshold 5"

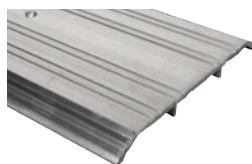

416S
Saddle Threshold 7"

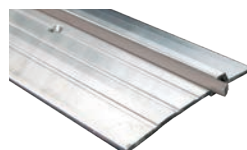

520S SVR Saddle
Threshold 5"

Adhesive Weatherstrip

Weatherstrip provides a seal for the door unit. The adhesive applied weatherstrip is recommended for low traffic areas, but can be used in high traffic areas, however will require replacement over time. The screw-on weatherstrip is recommended for high traffic areas.

	Charcoal
726C Adhesive Weatherstrip- 17' Roll	x
726C Adhesive Weatherstrip - 21' Roll	x



726C
Adhesive
Weatherstrip

Door Bottom

The door bottom wraps the entire bottom of the door and provides a seal against water and air.



	3/0	4/0
779S Door Bottom	x	x

779S
Door Bottom

Shims

	Grey Primer
4-1/2" Door Hinge Shim	x
4-1/2" Frame Hinge Shim	x



4-1/2" Door
Hinge Shim



4-1/2" Frame
Hinge Shim

Hardware Finishes

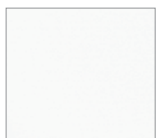

USP
Primed

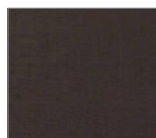

US10B
Oil Rubbed
Bronze



US26D
Satin Chrome

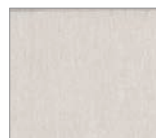

US28
Aluminum

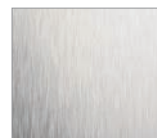

US32D
Stainless Steel

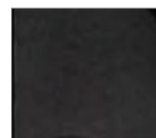

L2
Dark Bronze



Charcoal

Screw-on Weatherstrip

	891S
Screw-on Weatherstrip 3/0 x 7/0	x
Screw-on Weatherstrip 4/0 x 7/0	x
Screw-on Weatherstrip 6/0 x 7/0	x



891S
Screw-on Weatherstrip

Flush Bolts

The commercial flushbolt is for use with hollow metal and fire rated double doors. It is a manually operated flushbolt that is 12" in length. The flushbolt is installed on the inactive door. Available in a variety of finishes, it is only stocked by Reeb in US10B and US26D.



Flush Bolt
12" extension
included, not
pictured.

	US10B	US26D
Flush Bolt 12"	x	x

Commercial Astragal

A metal edge and a metal edge astragal are required to label a 90 minute fire-rated wood double door.

	6/8	7/0
Metal Edge Set		x
Metal Edge and Astragal Set	x	x

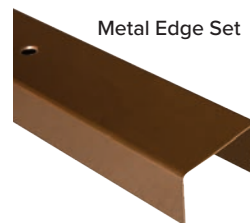

Metal Edge Set



Metal Edge &
Astragal Set

SteelCraft® Specifications

Many of Reeb's Commercial doors and frames are manufactured to SteelCraft specifications. These specifications relate to the location of the hinges and bore. If replacing a door only, it is important to know where the hinges and bore fall on the door. A non-SteelCraft door will not work in a SteelCraft frame.

SteelCraft hinge and strike specifications are consistent with Amveld doors, a once popular product in many of Reeb's northeast territories. **Please note, our stock Pioneer hollow metal frames are manufactured to SteelCraft specifications.** If your project requires hollow metal doors or frames with Pioneer, Ceco, Curries or any other specifications, Reeb will place a special order with the manufacturer to meet your requirements.

Standard SteelCraft® Specifications

Stock Door Hinge/Bore Locations

HEIGHT	A	B	C	D
6/8	7-3/8"	37-5/16"	67-1/4"	39-9/16"
7/0	7-3/8"	39-5/16"	71-1/4"	43-9/16"

Doors are undersized 1/4" width and 3/4" height

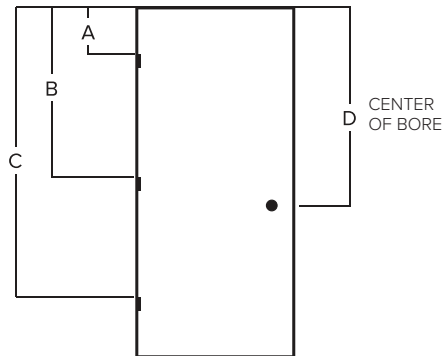

Hinge measurements are from the top inside of the head jamb to the top of the hinge.

Height	A	B	C	D
6/8	7-1/2"	37-7/16"	67-3/8"	39-11/16"
7/0	7-1/2"	39-7/16"	71-3/8"	43-11/16"

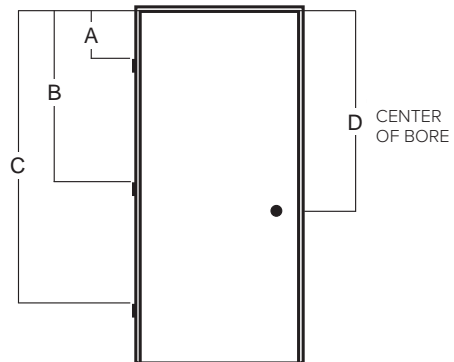

Delivery Details

All hollow metal frames and hardware are tagged and bundled together, per opening, and will arrive in one convenient packing. Reeb will install lite kits and apply fire labels to save you time.



• Pictured: Frame and Hardware bundles

Neutral and Positive Pressure

The Underwriters Laboratory (UL) and Warnock Hersey (Intertek Testing Services) are the entities that test and rate all fire doors. To properly rate the door, it must be tested as a complete unit with hardware and installed on a wall with a test environment behind it. The primary purpose of the test is to ensure the door can contain the spread of the fire.

Neutral Pressure

Neutral pressure assumes the pressure plane to be above the top of the door, and the pressure will not build up in the room containing the fire. Air flows into the room at the bottom and top of the door preventing flames from spreading. A weatherstrip helps to eliminate the smoke leaving the room.

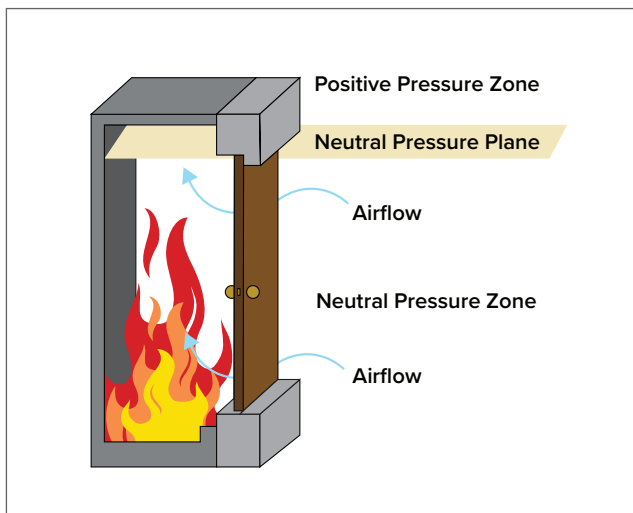

Positive Pressure

Positive pressure assumes the pressure plane is 40" from the bottom of the door. A neutral pressure area is below the pressure plane, and a positive pressure area is above the plane. Air flows into the room at the bottom but flows out at the top. Along with the circulating air, dangerous gases or flames may also escape causing the door's face to burn.

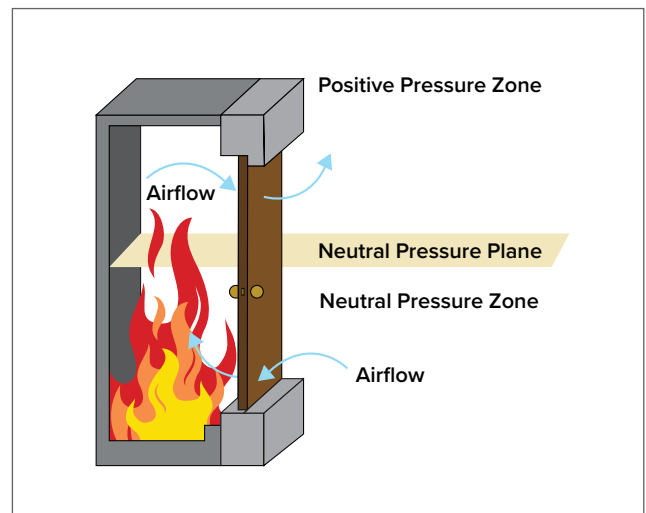

Reinforced Doors

Steel-edge doors with a bore may also need a door closer, while doors with no bore will need panic hardware.

Additional reinforcements are necessary to ensure the door will stand up to continual usage. A reinforced door includes additional material on the back of the door skin for extra protection.

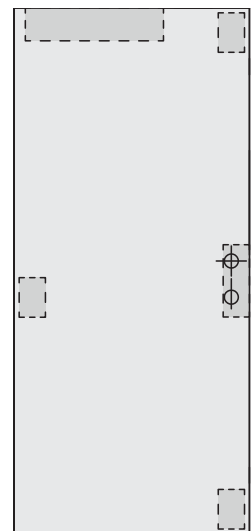

Handing

Single Doors

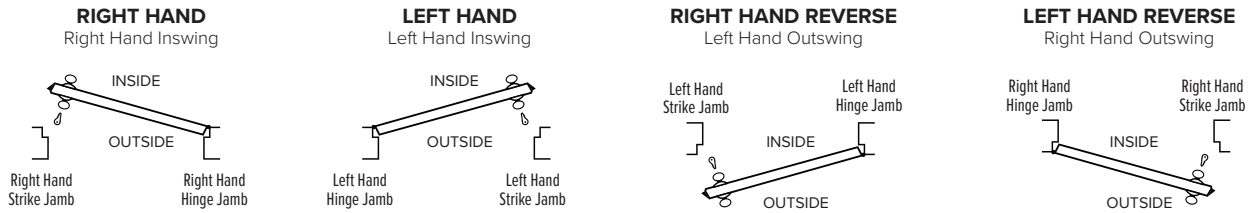

Double Doors

When door leaf swings towards you and hinges are on the right side of active leaf – Door is R.H.R Active / Frame is L.H. Active

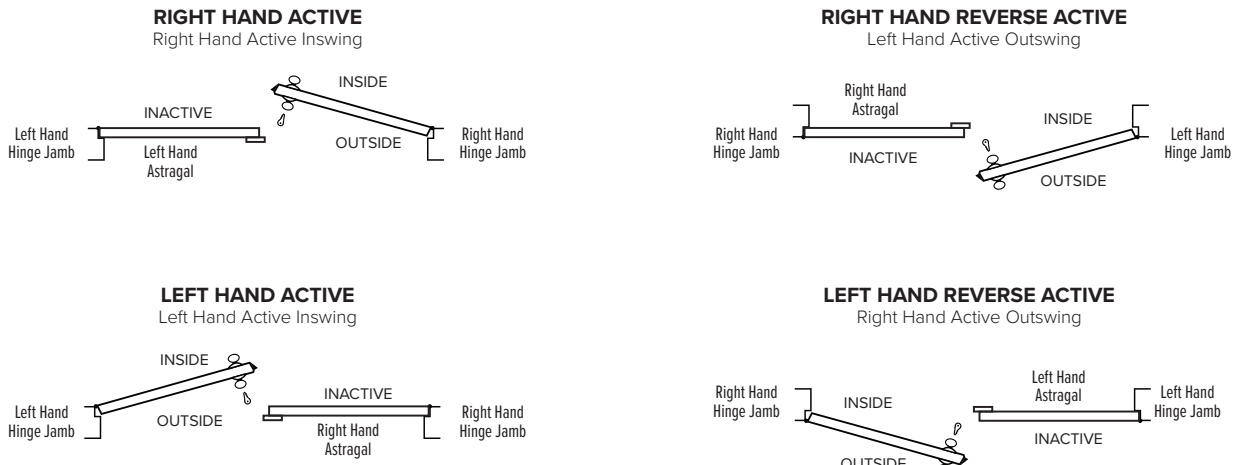

Commercial Doors are handed from the Secure (Key) side of the door.

Residential Fire Doors

Looking for light commercial and residential applications? Check out our in-stock Residential Fire Doors Catalog to learn more at reeb.com/catalogs





REEB
LEARNING CENTER

A learning center for everything door related.

Visit the Reeb® Learning Center for education on choosing the proper door unit, new products, and what product options are available.

Visit the Reeb Learning Center at learn.reeb.com.

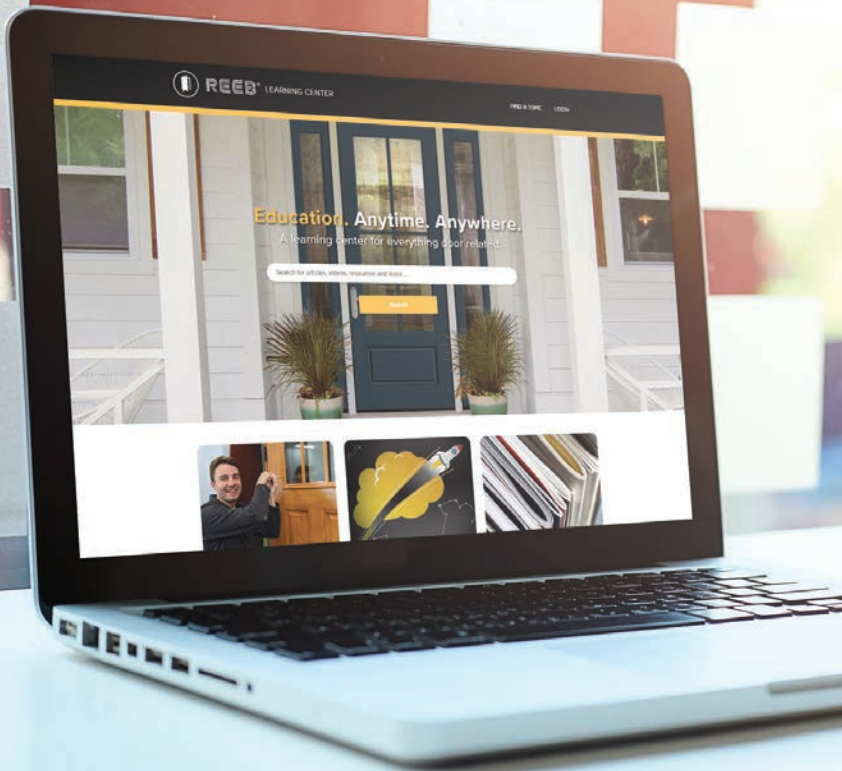
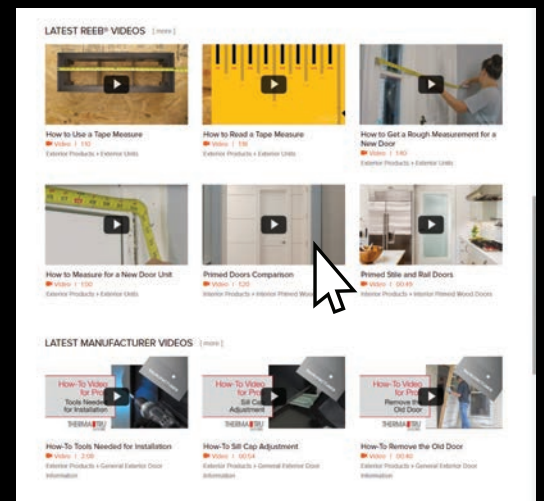

Online Commercial Doors Catalog

For an interactive format of this catalog, please visit reeb.com/catalogs



Reeb® Warranty Information

View product warranties visit reeb.com/warranties

□ Bethlehem, PA
1000 Maloney Cir.
Bethlehem, PA 18015
(800) 862-8622 voice
(800) 772-7332 fax

□ Barclay, MD
1315 Goldsboro Rd.
Barclay, MD 21607
(800) 825-8331 voice
(800) 331-9387 fax

□ Mocksville, NC
346 Bethel Church Rd.
Mocksville, NC 27028
(800) 642-0886 voice
(800) 618-0620 fax

□ Providence, RI
19 Business Park Dr.
Smithfield, RI 02917
(800) 343-5703 voice
(800) 388-5979 fax

□ Syracuse, NY
7475 Henry Clay Blvd.
Liverpool, NY 13088
(800) 422-5224 voice
(800) 531-7332 fax



PART# REEBCOM22

VERSION 1.0.0