

# INTERIOR DOORS

REEB<sup>®</sup> IN-STOCK INTERIOR STILE & RAIL CATALOG



# Introduction



## Interior Doors

Interior stile and rail doors are made from real wood bringing a warmth to any home. Reeb® stocks a number of species and designs to ensure that the style you are looking for is available. Reeb offers choices and options to help make the house feel like a home.

# Table of Contents

---

<b>Wood Species</b> .....	4	<b>Douglas Fir</b> .....	32	<b>Barn Door Hardware</b> .....	56
<b>Glass Options</b> .....	6	3/8" Flat Panel .....	32	Goldberg, Finish Options.....	56
<b>Get Creative</b> .....	7	Double Hip Raised Panel.....	36	<b>Flat Frames</b> .....	58
<b>Wood Doors Construction</b> .....	8	3/4" Double Hip Raised Panel.....	37	Stops.....	59
<b>Ponderosa Pine</b> .....	10	1-3/16" Double Hip Raised Panel .....	37	<b>Rabbeted Frames</b> .....	60
1-3/16" Double Hip Raised Panel .....	10	French, Clear Glass.....	38	Single Rabbeted .....	60
9/16" Single Hip Raised Panel .....	12	French, White Laminate Glass.....	39	Double Rabbeted.....	60
1/4" Flat Panel.....	15	French, 1-1/4" Bar.....	40	<b>Split Frames</b> .....	61
French, 1-5/16" Bar, Clear Glass .....	16	French, 1-1/4" Bar, Clear Glass .....	40	<b>Sills</b> .....	61
French, 1" TDL Bar, Clear Glass.....	18	French, 1-1/4" Bar, Satin Etch Glass .....	41	<b>Hinges</b> .....	62
French, Clear Glass.....	18	Decorative Glass .....	42	Baldwin®.....	64
French, V-Groove Glass.....	19	20 Minute Fire Rated Doors .....	44	Emtek®.....	64
Transoms, Clear Glass .....	19	3/4" Fire Rated Flat Panel .....	45	Reeb® Specialty Products.....	65
<b>Plantation Pine</b> .....	20	1-7/16" Fire Rated Raised Panel.....	45	<b>Locks</b> .....	66
11/16" Double Hip Raised Panel.....	20	<b>Maple</b> .....	46	<b>Stile &amp; Rail Dimensions</b> .....	70
9/16" Single Hip Raised Panel.....	22	3/8" Flat Panel .....	47	<b>Finishing</b> .....	74
3/8" Flat Panel .....	24	<b>Knotty Alder</b> .....	48	<b>Educational Tools</b> .....	75
French, 1-3/8" Bar, Clear Glass .....	26	1-1/8" V-Groove Plank Raised Panel.....	49		
French, Clear Glass.....	27	1-3/16" Aspen Raised Panel .....	49		
<b>Pine Louvers</b> .....	28	<b>Red Oak</b> .....	50		
Ponderosa Pine Louvers.....	29	3/4" Double Hip Raised Panel.....	51		
Plantation Pine Louvers.....	29	French, 1-1/4" Bar, Clear Glass .....	52		
<b>Knotty Pine</b> .....	30	<b>Barn Doors</b> .....	54		
11/16" Double Hip Raised Panel.....	30	Woodgrain, Ponderosa Pine.....	54		
		Woodgrain, Knotty Alder.....	55		

# Wood Species

Reeb® stocks a variety of wood species to match any home's design. Staining a door brings a layer of beauty and sophistication to an area. Each species of wood has different characteristics, colors, and grain patterns which affect the stain application. To help understand which doors stain well and which are better painted, Reeb has created icons which identify the stainability of a species.



**PONDEROSA PINE - \$**      **PAGE 10 - 19, 29 (Louvers)**



**PLANTATION PINE - \$**      **PAGE 20 - 27, 29 (Louvers)**



**KNOTTY PINE - \$**      **PAGE 30 - 31**



**DOUGLAS FIR - \$\$**      **PAGE 32 - 45**



MAPLE - \$\$

PAGE 46 - 47

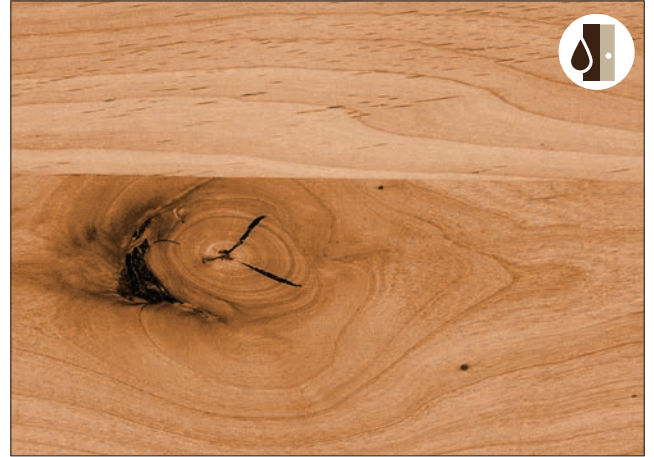

KNOTTY ALDER - \$\$

PAGE 48 - 49



RED OAK - \$\$\$

PAGE 50 - 53

See pages 8 - 9 for more information on Interior Wood door construction.

# Glass Options

Glass brings additional natural light and warmth into a room. Clear glass brings the maximum natural light flow while frit or satin etch glass add privacy. To easily identify the level of privacy, a privacy indicator is included with each glass type below.



Clear glass provides the maximum amount of light with no privacy; Reeb's stock of clear glass is tempered.



Clear Beveled glass has a bevel to the edge of the glass to provide a decorative element.



Satin Etch glass is semi-opaque glass with an etched frosted texture on one side that resists dirt.

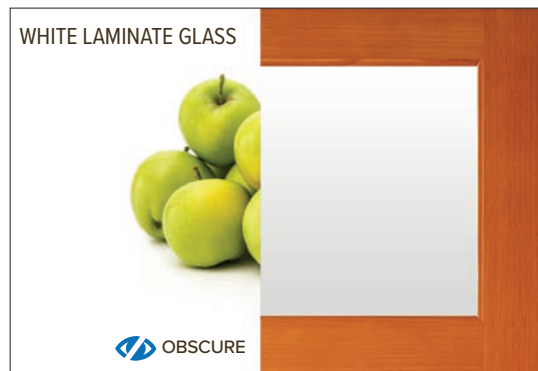

White Laminate glass offers the highest level of privacy with a vinyl interlayer between two pieces of glass, resulting in a smooth surface on both sides.



Frit glass in non-primed wood doors is a non-porous, semi-opaque glass with a texture on one side. The glass has a slight bluish gray appearance.

# Get Creative

Add a level of creativity to the home by choosing one of these unique door styles.



DECORATIVE - F88421

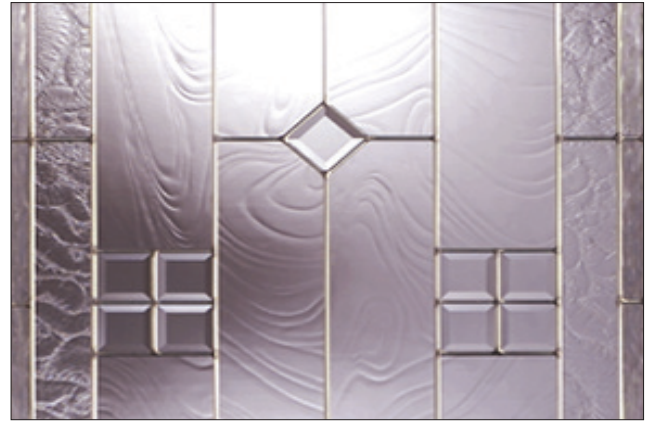

DECORATIVE - F88464



CLEAR ART ON SATIN ETCH - F1590



MAGNETIC CHALKBOARD - F1120



## Special Order Products

Reeb's in-stock collection includes many design options for your convenience, however the possibilities are endless. If you do not see what you are looking for in this catalog, it is likely we can still create it as a special order product.

Contact your Reeb® representative for custom door designs.

# Wood Doors

## CONSTRUCTION

For homeowners seeking a classic look, authentic stile and rail doors offer a level of detail and definition that cannot be matched. Stile and rail construction is architecturally correct and provides crisp shadow lines and highly defined panel details. Staining an interior wood door protects and enhances the natural beauty of real wood. Any door can be painted, however Reeb® stocks Primed Stile and Rail doors that are specifically designed for this purpose. **For more information, go to [reeb.com/catalogs](http://reeb.com/catalogs).**

- 1 Stile:** The stiles have a solid engineered core for added strength and stability.
- 2 Rail:** The rails are also made of solid engineered core.
- 3 Panel/Glass:** Panels can be wood to create a solid door, or replaced with glass to create a French door.
- 4 Dowel Pins:** Dowel pins are used to join the stiles and rails together.
- 5 Veneer:** A veneer is added over the core to create a smooth staining or painting surface.

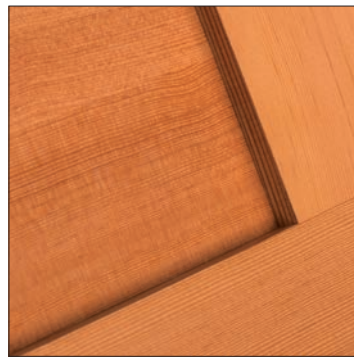

### Sharp Detail

Door components in a wood stile and rail door join together creating sharp shadow lines and greater definition.



### Architectural Correctness

Each door is made with perfectly proportioned stiles, rails and panels that are created individually to ensure that every door is architecturally correct.

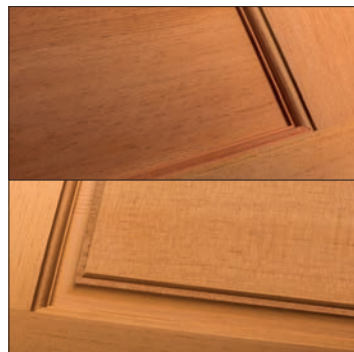

### Panel Design

Doors can be designed with 3/8" flat panels or raised panels with an option of single hip or double hip.



### Finishing

The surface of the door can be painted or stained depending on the wood species. Some species are easier to stain than others and we identify this with a "stainability" icon. **See page 4.**



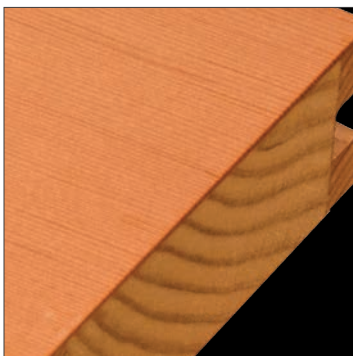

**Solid Engineered Core**

The interior of a wood stile and rail door has a solid engineered core adding stability. Some doors may use an alternate core which can be wood block, wood stave or other engineered fiber product.



**Dowel Pins**

Traditional dowel pin construction creates a secure joint, connecting stile and rail components together.



**Veneer**

A high-quality veneer is applied on top of the core for a perfect staining or painting surface.

# Ponderosa Pine



## 1-3/16" DOUBLE HIP RAISED PANEL

Ponderosa Pine is one of America's most abundant tree species. It has straight, uniform grain with minimal amounts of reddish-brown heartwood. The sapwood has wide growth bands, which are honey-toned or straw-colored.



1-3/16" Double Hip Raised Panel, Ovolo Sticking



Species Close Up



Ovolo Sticking

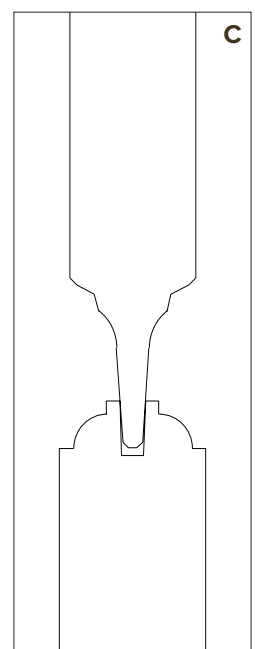
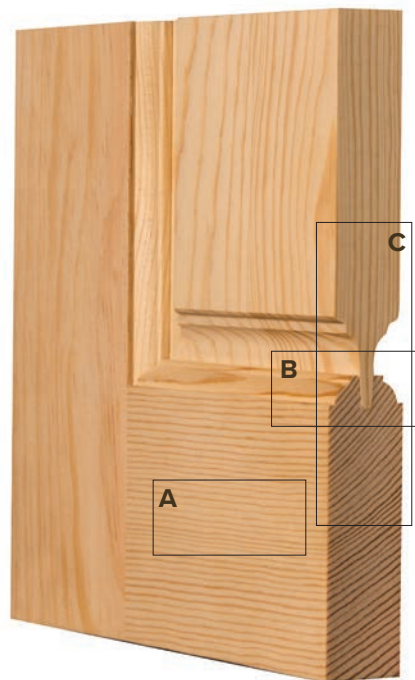

Panel Profile

**1-3/16" DOUBLE HIP RAISED PANEL**



**P82 1-3/8"**  
1-3/16" Raised Panel,  
Ovolo Sticking

1/0 x 6/8	1/6 x 6/8	2/4 x 6/8	3/0 x 6/8
1/2 x 6/8	1/8 x 6/8	2/6 x 6/8	
1/3 x 6/8	1/10 x 6/8	2/8 x 6/8	
1/4 x 6/8	2/0 x 6/8	2/10 x 6/8	



**P82A 1-3/8"**  
1-3/16" Raised Panel,  
Ovolo Sticking

1/0 x 6/8	1/6 x 6/8	2/4 x 6/8	3/0 x 6/8
1/2 x 6/8	1/8 x 6/8	2/6 x 6/8	
1/3 x 6/8	1/10 x 6/8	2/8 x 6/8	
1/4 x 6/8	2/0 x 6/8	2/10 x 6/8	



**P64 1-3/8"**  
1-3/16" Raised Panel,  
Ovolo Sticking

1/6 x 6/8	2/8 x 6/8
2/0 x 6/8	3/0 x 6/8
2/4 x 6/8	
2/6 x 6/8	



**P82, Woodgrain**

# Ponderosa Pine



## 9/16" SINGLE HIP RAISED PANEL

Ponderosa Pine is one of America's most abundant tree species. It has straight, uniform grain with minimal amounts of reddish-brown heartwood. The sapwood has wide growth bands, which are honey-toned or straw-colored.



9/16" Single Hip Raised Panel, Ovolo Sticking



Species Close Up

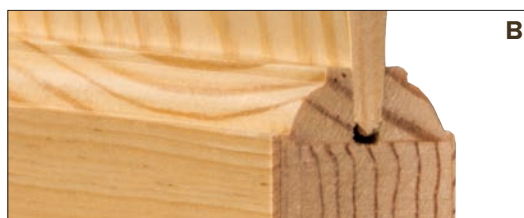

Ovolo Sticking

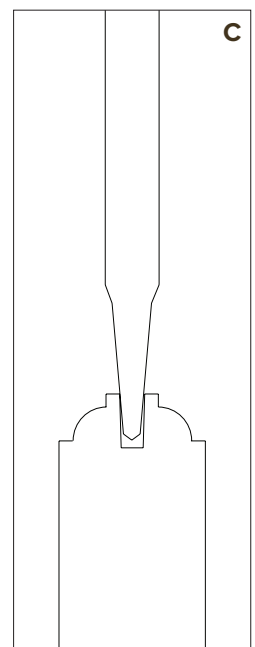
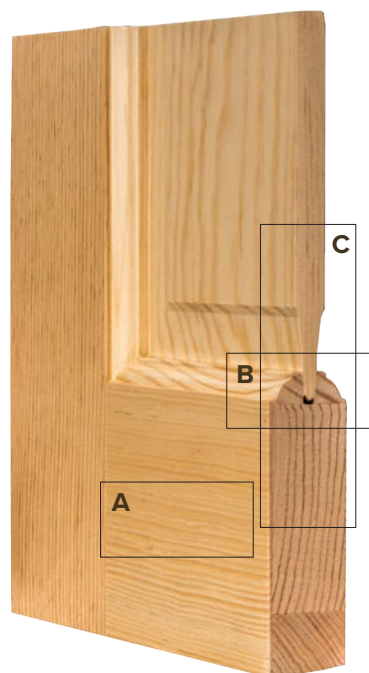

Panel Profile

## 9/16" SINGLE HIP RAISED PANEL

Bifolds are carton packed with track and hardware.



**P44 1-3/8"**  
9/16" Raised Panel, Ovolo Sticking

1/0 x 6/0	1/0 x 6/6	1/0 x 6/8	1/0 x 7/0
1/2 x 6/0	1/2 x 6/6	1/2 x 6/8	1/2 x 7/0
1/3 x 6/0	1/3 x 6/6	1/3 x 6/8	1/3 x 7/0
1/4 x 6/0	1/4 x 6/6	1/4 x 6/8	1/4 x 7/0
1/6 x 6/0	1/6 x 6/6	1/6 x 6/8	1/6 x 7/0
1/8 x 6/0	1/8 x 6/6	1/8 x 6/8	1/8 x 7/0
2/0 x 6/0	2/0 x 6/6	1/10 x 6/8	2/0 x 7/0
2/2 x 6/0	2/2 x 6/6	2/0 x 6/8	2/2 x 7/0
2/4 x 6/0	2/4 x 6/6	2/2 x 6/8	2/4 x 7/0
2/6 x 6/0	2/6 x 6/6	2/4 x 6/8	2/6 x 7/0
2/8 x 6/0	2/8 x 6/6	2/6 x 6/8	2/8 x 7/0
3/0 x 6/0	3/0 x 6/6	2/8 x 6/8	2/10 x 7/0
		2/10 x 6/8	3/0 x 7/0
		3/0 x 6/8	



**P44 BIFOLD 1-3/8"**  
9/16" Raised Panel, Ovolo Sticking

2/0 x 6/8
2/4 x 6/8
2/6 x 6/8
2/8 x 6/8
3/0 x 6/8
4/0 x 6/8
4/8 x 6/8
5/0 x 6/8
5/4 x 6/8
6/0 x 6/8



**P45 1-3/8"**  
9/16" Raised Panel, Ovolo Sticking

1/6 x 6/8
2/0 x 6/8
2/6 x 6/8
2/6 x 6/8
2/8 x 6/8
3/0 x 6/8



**P85 1-3/8"**  
9/16" Raised Panel, Ovolo Sticking

1/3 x 6/8
1/6 x 6/8
2/0 x 6/8
2/4 x 6/8
2/4 x 6/8
2/6 x 6/8
2/8 x 6/8
3/0 x 6/8



**P108 1-3/8"**  
9/16" Raised Panel, Ovolo Sticking

1/0 x 6/0	1/0 x 6/6	1/0 x 6/8	1/0 x 7/0
1/2 x 6/0	1/2 x 6/6	1/2 x 6/8	1/2 x 7/0
1/3 x 6/0	1/3 x 6/6	1/3 x 6/8	1/3 x 7/0
1/4 x 6/0	1/4 x 6/6	1/4 x 6/8	1/4 x 7/0
1/6 x 6/0	1/6 x 6/6	1/6 x 6/8	1/6 x 7/0
1/8 x 6/0	1/8 x 6/6	1/8 x 6/8	1/8 x 7/0
2/0 x 6/0	2/0 x 6/6	1/10 x 6/8	2/0 x 7/0
2/2 x 6/0	2/2 x 6/6	2/0 x 6/8	2/2 x 7/0
2/4 x 6/0	2/4 x 6/6	2/2 x 6/8	2/4 x 7/0
2/6 x 6/0	2/6 x 6/6	2/4 x 6/8	2/6 x 7/0
2/8 x 6/0	2/8 x 6/6	2/6 x 6/8	2/8 x 7/0
3/0 x 6/0	3/0 x 6/6	2/8 x 6/8	2/10 x 7/0
		2/10 x 6/8	3/0 x 7/0
		3/0 x 6/8	



**P108 BIFOLD 1-3/8"**  
9/16" Raised Panel, Ovolo Sticking

2/0 x 6/8
2/4 x 6/8
2/6 x 6/8
2/8 x 6/8
3/0 x 6/8
4/0 x 6/8
4/0 x 6/8
4/8 x 6/8
5/0 x 6/8
5/4 x 6/8
6/0 x 6/8



**P67 1-3/8"**  
9/16" Raised Panel, Ovolo Sticking

1/4 x 6/8
1/6 x 6/8
2/0 x 6/8
2/4 x 6/8
2/6 x 6/8
2/8 x 6/8
3/0 x 6/8



**P1088 1-3/8"**  
9/16" Raised Panel, Ovolo Sticking

1/6 x 6/8
2/0 x 6/8
2/4 x 6/8
2/6 x 6/8
2/8 x 6/8
3/0 x 6/8

# Ponderosa Pine



## 9/16" SINGLE HIP RAISED PANEL

Ponderosa Pine is one of America's most abundant tree species. It has straight, uniform grain with minimal amounts of reddish-brown heartwood. The sapwood has wide growth bands, which are honey-toned or straw-colored.

### 9/16" SINGLE HIP RAISED PANEL

Bifolds are carton packed with track and hardware.



**P1053 1-3/8"**  
9/16" Raised Panel,  
Ovolo Sticking  
Reverse Layout

1/6 x 6/6	1/0 x 6/8	2/0 x 6/8
2/0 x 6/6	1/2 x 6/8	2/2 x 6/8
2/4 x 6/6	1/3 x 6/8	2/4 x 6/8
2/6 x 6/6	1/4 x 6/8	2/6 x 6/8
2/8 x 6/6	1/6 x 6/8	2/8 x 6/8
3/0 x 6/6	1/8 x 6/8	2/10 x 6/8
	1/10 x 6/8	3/0 x 6/8



**P1053 BIFOLD 1-3/8"**  
9/16" Raised Panel,  
Ovolo Sticking  
Reverse Layout

2/0 x 6/8	5/0 x 6/8
2/4 x 6/8	5/4 x 6/8
2/6 x 6/8	6/0 x 6/8
2/8 x 6/8	
3/0 x 6/8	
4/0 x 6/8	
4/8 x 6/8	



**P1051 1-3/8"**  
9/16" Raised Panel,  
Ovolo Sticking  
Reverse Layout

1/6 x 6/6	1/0 x 6/8	2/0 x 6/8
2/0 x 6/6	1/2 x 6/8	2/2 x 6/8
2/4 x 6/6	1/3 x 6/8	2/4 x 6/8
2/6 x 6/6	1/4 x 6/8	2/6 x 6/8
2/8 x 6/6	1/6 x 6/8	2/8 x 6/8
3/0 x 6/6	1/8 x 6/8	2/10 x 6/8
	1/10 x 6/8	3/0 x 6/8



**P1051 BIFOLD 1-3/8"**  
9/16" Raised Panel,  
Ovolo Sticking  
Reverse Layout

2/0 x 6/8	5/0 x 6/8
2/4 x 6/8	5/4 x 6/8
2/6 x 6/8	6/0 x 6/8
2/8 x 6/8	
3/0 x 6/8	
4/0 x 6/8	
4/8 x 6/8	

**P44 - Standard Layout**

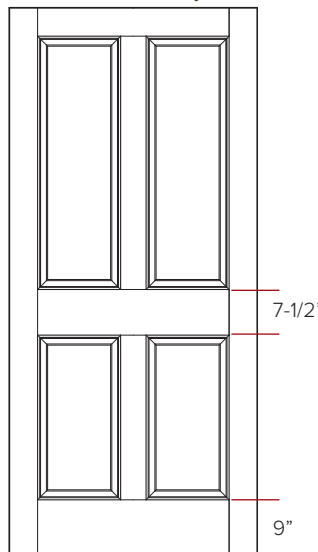

**P1053 - Reverse Layout**

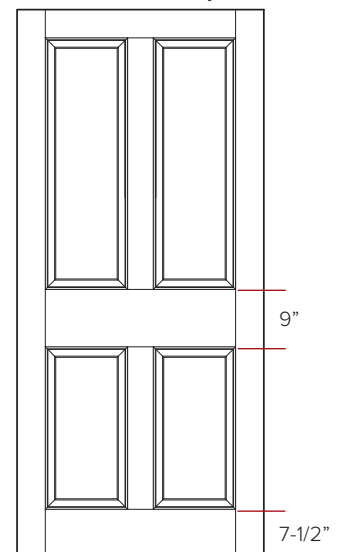

The doors on this page offer a Reverse Layout.

Compared to Standard Layout doors (see page 13), Reverse Layout doors switch the intermediate and bottom panels, as well as lock rail and bottom rail, for a different look.

# Ponderosa Pine



MODERATE  
STAINABILITY

## 1/4" FLAT PANEL

Ponderosa Pine is one of America's most abundant tree species. It has straight, uniform grain with minimal amounts of reddish-brown heartwood. The sapwood has wide growth bands, which are honey-toned or straw-colored.



1/4" Flat Panel

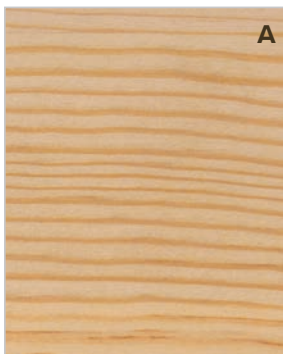

Species Close Up



Picture Frame Layout

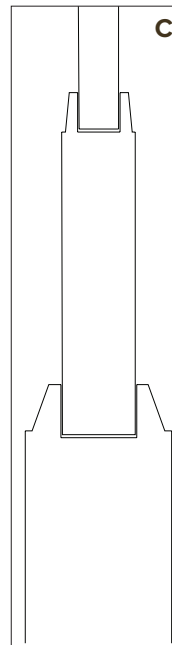
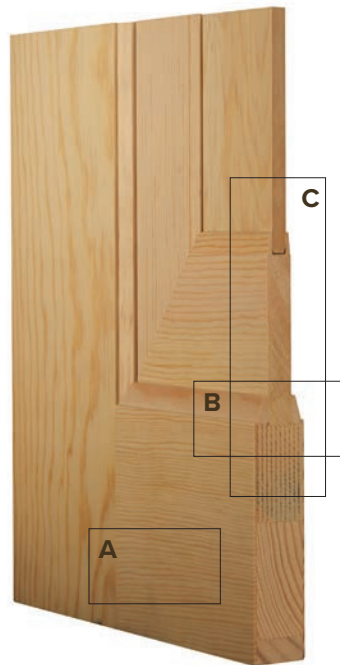

Panel Profile



**P4127 1-3/8"**  
1/4" Flat Panel,  
Picture Frame Layout

2/0 x 6/8    3/0 x 6/8  
2/4 x 6/8  
2/6 x 6/8  
2/8 x 6/8

The interior of a wood stile and rail door has a solid engineered core adding stability. Some doors may use an alternate core which can be wood block, wood stave or other engineered fiber product.



# Ponderosa Pine



## FRENCH - 1-5/16" BAR

Ponderosa Pine is one of America's most abundant tree species. It has straight, uniform grain with minimal amounts of reddish-brown heartwood. The sapwood has wide growth bands, which are honey-toned or straw-colored.



1-5/16" Bar with Clear Glass



1-5/16" Bar Close Up

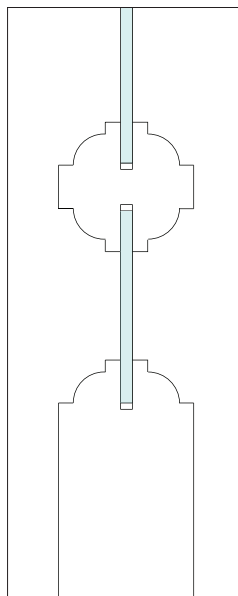

1-5/16" Bar Profile



P1515B, Clear Beveled Glass



**1-5/16" BAR**

Bifolds are carton packed with track and hardware.



**P1509 1-3/8"**  
 1-5/16" Bar, Clear Glass  
 2/6 x 6/8  
 2/8 x 6/8  
 3/0 x 6/8



**P1505 1-3/8"**  
 1-5/16" Bar, Clear Glass  
 1/0 x 6/8    2/6 x 6/8  
 1/2 x 6/8    2/8 x 6/8  
 1/3 x 6/8    3/0 x 6/8  
 1/4 x 6/8  
 1/6 x 6/8



**P1510 1-3/8"**  
 1-5/16" Bar, Clear Glass  
 1/8 x 6/8    2/0 x 7/0  
 1/10 x 6/8  
 2/0 x 6/8  
 2/2 x 6/8  
 2/4 x 6/8  
 2/6 x 6/8  
 2/8 x 6/8  
 3/0 x 6/8



**P1515 1-3/8"**  
 1-5/16" Bar, Clear Glass  
 2/4 x 6/8    2/4 x 7/0  
 2/6 x 6/8    2/6 x 7/0  
 2/8 x 6/8    2/8 x 7/0  
 2/10 x 6/8    3/0 x 7/0  
 3/0 x 6/8



**P1515B 1-3/8"**  
 1-5/16" Bar, Clear Beveled Glass  
 2/4 x 6/8  
 2/6 x 6/8  
 2/8 x 6/8  
 3/0 x 6/8



**P1705 BIFOLD 1-3/8"**  
 1-5/16" Bar, Clear Glass  
 2/0 x 6/8    4/0 x 6/8  
 2/6 x 6/8    5/0 x 6/8  
 2/8 x 6/8    5/4 x 6/8  
 3/0 x 6/8    6/0 x 6/8

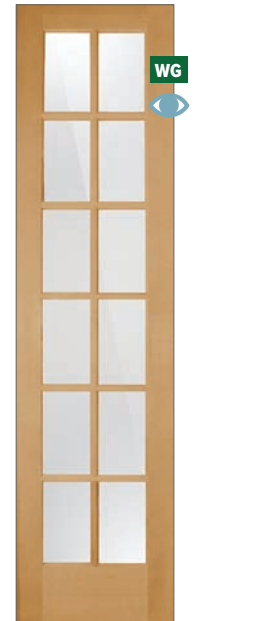

**P1512 1-3/8"**  
 1-5/16" Bar, Clear Glass  
 2/0 x 8/0



**P1518 1-3/8"**  
 1-5/16" Bar, Clear Glass  
 2/4 x 8/0  
 2/6 x 8/0  
 2/8 x 8/0  
 3/0 x 8/0

# Ponderosa Pine



## FRENCH

Ponderosa Pine is one of America's most abundant tree species. It has straight, uniform grain with minimal amounts of reddish-brown heartwood. The sapwood has wide growth bands, which are honey-toned or straw-colored.



1" TDL Bar with Clear Glass

### 1" TDL BAR



**P1510FC 1-3/8"**  
1" TDL Bar, Clear Glass

2/0 x 6/8  
2/4 x 6/8



**P1515FC 1-3/8"**  
1" TDL Bar, Clear Glass

2/6 x 6/8  
2/8 x 6/8  
3/0 x 6/8

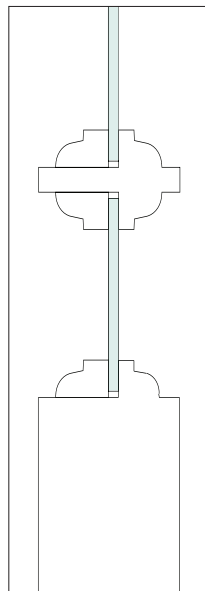

1" TDL Bar Profile

### CLEAR GLASS



**P1501 1-3/8"**  
Clear Glass

2/0 x 6/8	2/8 x 6/8	2/0 x 7/0	2/8 x 7/0
2/2 x 6/8	2/10 x 6/8	2/2 x 7/0	3/0 x 7/0
2/4 x 6/8	3/0 x 6/8	2/4 x 7/0	
2/6 x 6/8		2/6 x 7/0	

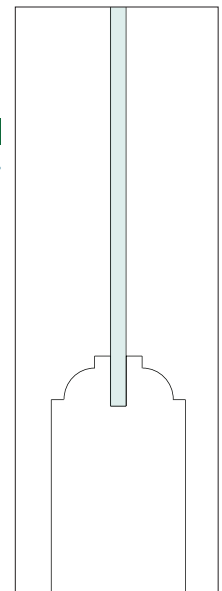

Full Lite Profile

**V-GROOVE**



**P3915 V-GROOVE 1-3/8"**  
V-Groove Glass

- 2/4 x 6/8
- 2/6 x 6/8
- 2/8 x 6/8
- 3/0 x 6/8

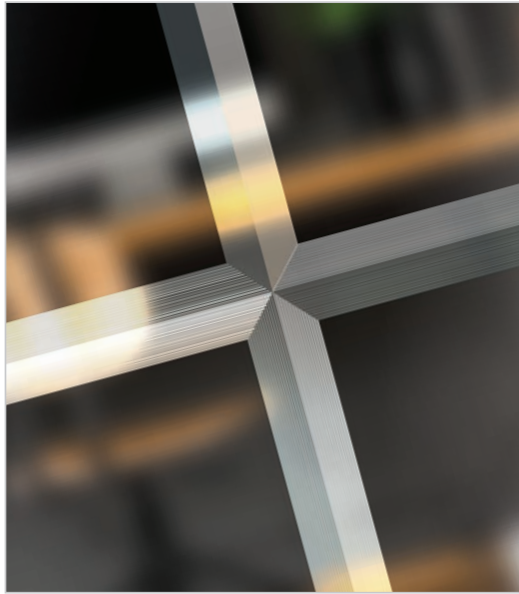

V-Groove Close Up

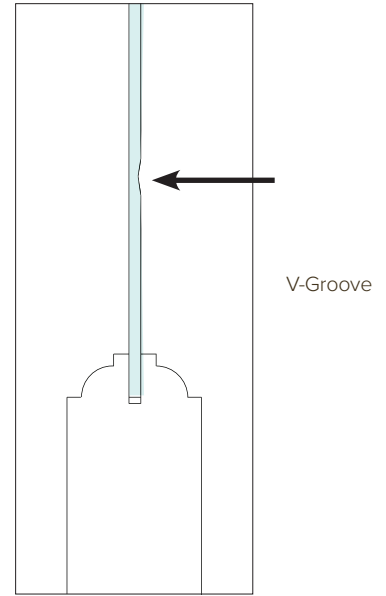

5/32" V-Groove Glass

# Transoms

**CLEAR GLASS**



**T001**

Clear Glass  
2/6, 2/8 & 3/0 for use with Single Door  
4/0 for use of 2/0 Double Door

- 2/6 x 1/0    4/0 x 1/0
- 2/8 x 1/0    5/0 x 1/0
- 3/0 x 1/0    6/0 x 1/0



**T004**

Divided Lites, Clear Glass  
For use with 2/0 Double Door  
4/0 x 1/0



**T003**

Divided Lites, Clear Glass  
For use with Single Door

- 2/6 x 1/0
- 2/8 x 1/0
- 3/0 x 1/0



**T005**

Divided Lites, Clear Glass  
5/0 x 1/0 for use with 2/6 Double Door  
6/0 x 1/0 for use with 3/0 Double Door

- 5/0 x 1/0
- 6/0 x 1/0

# Plantation Pine



## 11/16" DOUBLE HIP RAISED PANEL

Plantation Pine has a distinctive grain pattern with a pale cream color. It tends to be harder than other pine species and has fewer knots.



11/16" Double Hip Raised Panel, Ovolo Sticking



Species Close Up



Ovolo Sticking

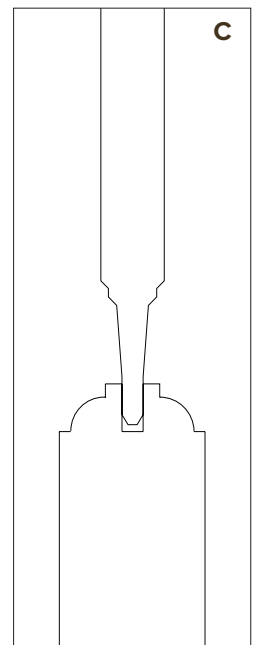
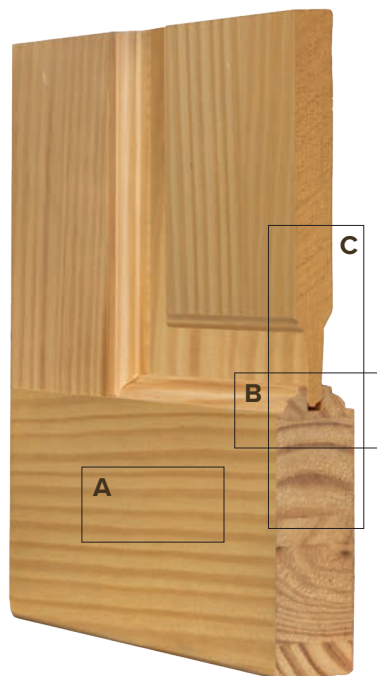

Panel Profile

**11/16" DOUBLE HIP RAISED PANEL**

Bifolds are carton packed with track and hardware.



**IP22V 1-3/8"**  
11/16" V-Groove Raised Panel,  
Ovolo Sticking

- 1/0 x 6/8
- 1/3 x 6/8
- 1/6 x 6/8
- 2/0 x 6/8
- 2/4 x 6/8
- 2/6 x 6/8
- 2/8 x 6/8
- 2/10 x 6/8
- 3/0 x 6/8



**IP44 1-3/8"**  
11/16" Raised Panel,  
Ovolo Sticking

- 1/0 x 6/8
- 1/3 x 6/8
- 1/6 x 6/8
- 2/0 x 6/8
- 2/4 x 6/8
- 2/6 x 6/8
- 2/8 x 6/8
- 2/10 x 6/8
- 3/0 x 6/8



**IP44 BIFOLD 1-3/8"**  
11/16" Raised Panel,  
Ovolo Sticking

- 2/0 x 6/8
- 2/6 x 6/8
- 3/0 x 6/8
- 4/0 x 6/8
- 5/0 x 6/8
- 6/0 x 6/8



**IP66 1-3/8"**  
11/16" Raised Panel,  
Ovolo Sticking

- 1/0 x 6/8
- 1/2 x 6/8
- 1/3 x 6/8
- 1/4 x 6/8
- 1/6 x 6/8
- 1/8 x 6/8
- 1/10 x 6/8
- 2/0 x 6/8
- 2/2 x 6/8
- 2/4 x 6/8
- 2/6 x 6/8
- 2/8 x 6/8
- 2/10 x 6/8
- 3/0 x 6/8
- 1/6 x 8/0
- 2/0 x 8/0
- 2/4 x 8/0
- 2/6 x 8/0
- 2/8 x 8/0
- 2/10 x 8/0
- 3/0 x 8/0



**IP66 BIFOLD 1-3/8"**  
11/16" Raised Panel,  
Ovolo Sticking

- 2/0 x 6/8
- 2/6 x 6/8
- 3/0 x 6/8
- 4/0 x 6/8
- 5/0 x 6/8
- 6/0 x 6/8

# Plantation Pine

## 9/16" SINGLE HIP RAISED PANEL



Plantation Pine has a distinctive grain pattern with a pale cream color. It tends to be harder than other pine species and has fewer knots.



9/16" Single Hip Raised Panel, Ovolo Sticking



Species Close Up

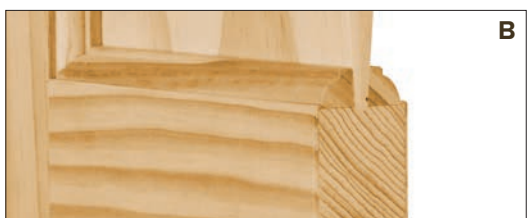

Ovolo Sticking

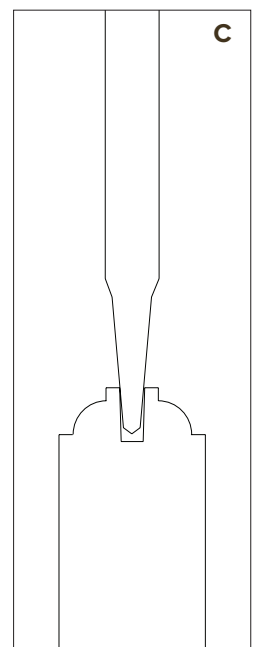
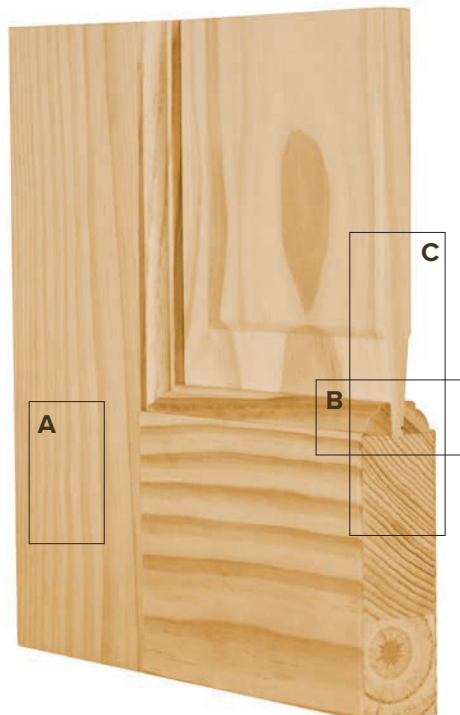

Panel Profile



**IP82A**, Reeb Specialty Products

**9/16" SINGLE HIP RAISED PANEL**



**IP82 1-3/8"**  
9/16" Raised Panel,  
Ovolo Sticking

- 1/6 x 6/8    1/6 x 8/0
- 2/0 x 6/8    2/0 x 8/0
- 2/4 x 6/8    2/4 x 8/0
- 2/6 x 6/8    2/6 x 8/0
- 2/8 x 6/8    2/8 x 8/0
- 3/0 x 6/8    3/0 x 8/0



**IP82A 1-3/8"**  
9/16" Raised Panel,  
Ovolo Sticking

- 1/6 x 6/8    1/6 x 8/0
- 2/0 x 6/8    2/0 x 8/0
- 2/4 x 6/8    2/4 x 8/0
- 2/6 x 6/8    2/6 x 8/0
- 2/8 x 6/8    2/8 x 8/0
- 3/0 x 6/8    3/0 x 8/0



**IP55 1-3/8"**  
9/16" Raised Panel,  
Ovolo Sticking

- 1/6 x 6/8
- 2/0 x 6/8
- 2/4 x 6/8
- 2/6 x 6/8
- 2/8 x 6/8
- 3/0 x 6/8



**IP56 1-3/8"**  
9/16" Raised Panel,  
Ovolo Sticking

- 1/6 x 8/0
- 2/0 x 8/0
- 2/4 x 8/0
- 2/6 x 8/0
- 2/8 x 8/0
- 3/0 x 8/0

# Plantation Pine



## 3/8" FLAT PANEL

Plantation Pine has a distinctive grain pattern with a pale cream color. It tends to be harder than other pine species and has fewer knots.



3/8" Flat Panel, Shaker Sticking



Species Close Up



Shaker Sticking

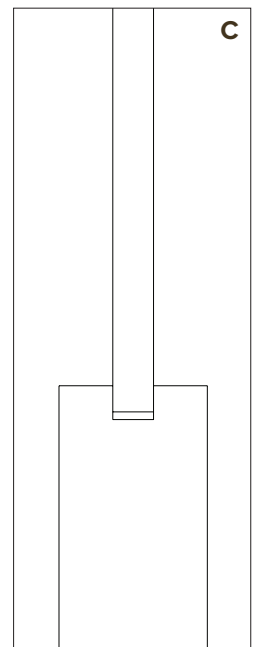
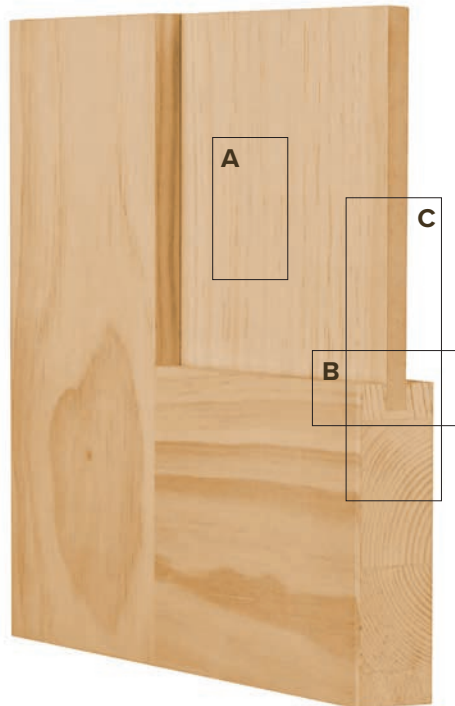

Panel Profile



**3/8" FLAT PANEL**



**IP720 1-3/8"**  
3/8" Flat Panel,  
Shaker Sticking

1/6 x 6/8	1/6 x 8/0
2/0 x 6/8	2/0 x 8/0
2/4 x 6/8	2/4 x 8/0
2/6 x 6/8	2/6 x 8/0
2/8 x 6/8	2/8 x 8/0
3/0 x 6/8	3/0 x 8/0



**IP730 1-3/8"**  
3/8" Flat Panel,  
Shaker Sticking

1/6 x 6/8	1/6 x 8/0
2/0 x 6/8	2/0 x 8/0
2/4 x 6/8	2/4 x 8/0
2/6 x 6/8	2/6 x 8/0
2/8 x 6/8	2/8 x 8/0
3/0 x 6/8	3/0 x 8/0



**IP760 1-3/8"**  
3/8" Flat Panel,  
Shaker Sticking

1/6 x 6/8	1/6 x 8/0
2/0 x 6/8	2/0 x 8/0
2/4 x 6/8	2/4 x 8/0
2/6 x 6/8	2/6 x 8/0
2/8 x 6/8	2/8 x 8/0
3/0 x 6/8	3/0 x 8/0



**IP782 1-3/8"**  
3/8" Flat Panel,  
Shaker Sticking

1/0 x 6/8	2/8 x 6/8	1/6 x 8/0
1/3 x 6/8	2/10 x 6/8	2/0 x 8/0
1/4 x 6/8	3/0 x 6/8	2/4 x 8/0
1/6 x 6/8		2/6 x 8/0
2/0 x 6/8		2/8 x 8/0
2/4 x 6/8		2/10 x 8/0
2/6 x 6/8		3/0 x 8/0



**IP755 1-3/8"**  
3/8" Flat Panel,  
Shaker Sticking

1/6 x 6/8
2/0 x 6/8
2/4 x 6/8
2/6 x 6/8
2/8 x 6/8
2/10 x 6/8
3/0 x 6/8



**IP756 1-3/8"**  
3/8" Flat Panel,  
Shaker Sticking

1/6 x 8/0
2/0 x 8/0
2/4 x 8/0
2/6 x 8/0
2/8 x 8/0
2/10 x 8/0
3/0 x 8/0

# Plantation Pine

## FRENCH



Plantation Pine has a distinctive grain pattern with a pale cream color. It tends to be harder than other pine species and has fewer knots.



1-3/8" Bar. Clear Glass



1-3/8" Bar Close Up

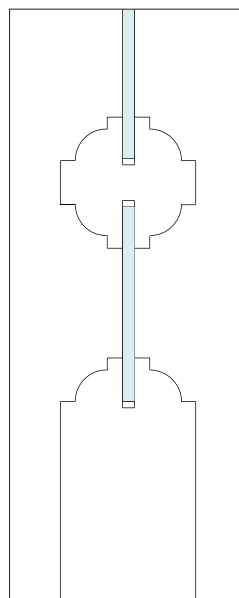

1-3/8" Bar Profile

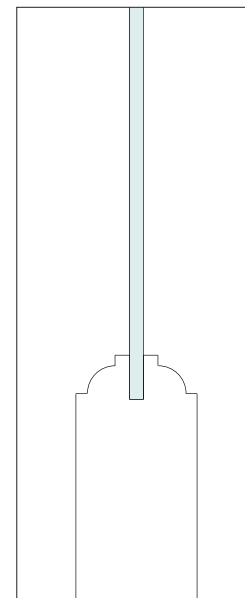

Full Lite Profile

**1-3/8" BAR**



**IP625 1-3/8"**  
1-3/8" Bar, Clear Glass  
1/6 x 6/8  
2/0 x 6/8  
2/4 x 6/8  
2/6 x 6/8  
2/8 x 6/8  
3/0 x 6/8



**IP627 1-3/8"**  
1-3/8" Bar, Clear Glass  
2/4 x 6/8  
2/6 x 6/8  
2/8 x 6/8  
2/10 x 6/8  
3/0 x 6/8



**IP626 1-3/8"**  
1-3/8" Bar, Clear Glass  
1/6 x 8/0  
2/0 x 8/0



**IP628 1-3/8"**  
1-3/8" Bar, Clear Glass  
2/4 x 8/0  
2/6 x 8/0  
2/8 x 8/0  
2/10 x 8/0  
3/0 x 8/0

**CLEAR GLASS**



**IP620 1-3/8"**  
Clear Glass  
1/6 x 6/8    1/6 x 8/0  
2/0 x 6/8    2/0 x 8/0  
2/4 x 6/8  
2/6 x 6/8  
2/8 x 6/8  
2/10 x 6/8  
3/0 x 6/8

**FRIT GLASS**



**IP620F 1-3/8"**  
Frit Glass  
1/6 x 6/8    1/6 x 8/0  
2/0 x 6/8    2/0 x 8/0  
2/4 x 6/8  
2/6 x 6/8  
2/8 x 6/8  
2/10 x 6/8  
3/0 x 6/8



**IP625F 1-3/8"**  
1-3/8" Bar, Frit Glass  
1/6 x 6/8  
2/0 x 6/8  
2/4 x 6/8  
2/6 x 6/8  
2/8 x 6/8  
3/0 x 6/8

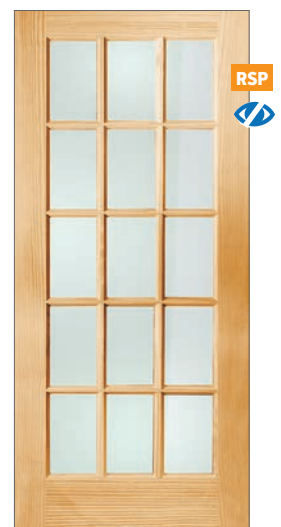

**IP627F 1-3/8"**  
1-3/8" Bar, Frit Glass  
2/4 x 6/8  
2/6 x 6/8  
2/8 x 6/8  
2/10 x 6/8  
3/0 x 6/8

# Pine Louvers

Louver doors allow for air flow while providing privacy.



1-1/4" Louver Slats

When ordering a louver door, it is important to specify which side is the blind side. View the door as if you are in the inside of the room and the door is opening toward you.

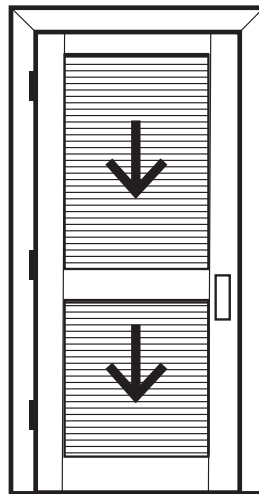

When the Blind Side is on the Hinge Side, the Louvers run down, meaning you cannot see into the next room

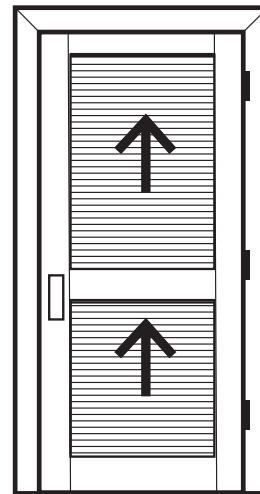

When the Blind Side is on the Stop Side, the Louvers run up, meaning you can see into the next room.

## PONDEROSA PINE

Bifolds are carton packed with track and hardware.



WG

### P730 1-3/8"

1-1/4" Louver Slats

2/0 x 6/0	1/0 x 6/8	2/2 x 6/8	1/6 x 7/0
2/6 x 6/0	1/2 x 6/8	2/4 x 6/8	2/0 x 7/0
1/6 x 6/6	1/3 x 6/8	2/6 x 6/8	2/4 x 7/0
2/0 x 6/6	1/4 x 6/8	2/8 x 6/8	2/6 x 7/0
2/4 x 6/6	1/6 x 6/8	2/10 x 6/8	2/8 x 7/0
2/6 x 6/6	1/8 x 6/8	3/0 x 6/8	3/0 x 7/0
2/8 x 6/6	1/10 x 6/8		
3/0 x 6/6	2/0 x 6/8		



WG

### P730 BIFOLD 1-3/8"

1-1/4" Louver Slats

2/0 x 6/8	5/4 x 6/8
2/4 x 6/8	6/0 x 6/8
2/6 x 6/8	
2/8 x 6/8	
3/0 x 6/8	
4/0 x 6/8	
4/8 x 6/8	
5/0 x 6/8	



WG

### P732 1-3/8"

1-1/4" Louver Slats,  
9/16" Single Hip Raised Panel

1/6 x 6/6	1/0 x 6/8	2/2 x 6/8
2/0 x 6/6	1/2 x 6/8	2/4 x 6/8
2/4 x 6/6	1/3 x 6/8	2/6 x 6/8
2/6 x 6/6	1/4 x 6/8	2/8 x 6/8
2/8 x 6/6	1/6 x 6/8	2/10 x 6/8
3/0 x 6/6	1/8 x 6/8	3/0 x 6/8
	1/10 x 6/8	
	2/0 x 6/8	



WG

### P732 BIFOLD 1-3/8"

1-1/4" Louver Slats  
9/16" Single Hip Raised Panel

2/0 x 6/8	5/0 x 6/8
2/4 x 6/8	5/4 x 6/8
2/6 x 6/8	6/0 x 6/8
2/8 x 6/8	
3/0 x 6/8	
4/0 x 6/8	
4/8 x 6/8	

## PLANTATION PINE

Bifolds are carton packed with track and hardware.



RSP

### PN730 BIFOLD 1-1/8"

1-1/4" Louver Slats  
1/2" Single Hip Raised Panel  
Recessed Rail

2/0 x 6/8
2/6 x 6/8
3/0 x 6/8
4/0 x 6/8
5/0 x 6/8
6/0 x 6/8



RSP

### PN732 BIFOLD 1-1/8"

1-1/4" Louver Slats  
1/2" Single Hip Raised Panel  
Recessed Rail

2/0 x 6/8
2/6 x 6/8
3/0 x 6/8
4/0 x 6/8
5/0 x 6/8
6/0 x 6/8



RSP

### PN108 BIFOLD 1-1/8"

1-1/4" Louver Slats  
1/2" Single Hip Raised Panel  
Recessed Rail

2/0 x 6/8
2/6 x 6/8
3/0 x 6/8
4/0 x 6/8
5/0 x 6/8
6/0 x 6/8

Recessed rails are rails that are not as thick as the stiles.

# Knotty Pine



## 11/16" DOUBLE HIP RAISED PANEL

Knotty Pine has a rich display of knots that reflects the randomness and beauty of nature. The wood tends to be a honey-toned or straw color while the knots are generally reddish-brown.



KP22/KP66, 11/16" Double Hip Raised Panel, Ovolo Sticking



KP22/KP66, Ovolo Sticking

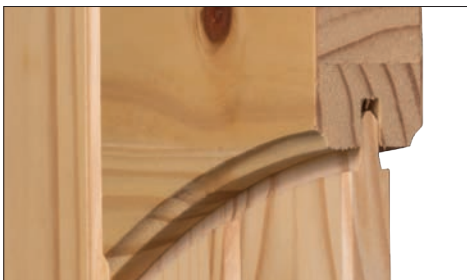

KP22V, Reticulated Sticking and Joint



KP22/KP66



KP22V

**11/16" DOUBLE HIP RAISED PANEL**



RSP

**KP22 1-3/8"**  
11/16" Raised Panel,  
Ovolo Sticking

- |            |            |
|------------|------------|
| 1/6 x 6/8  | 1/6 x 8/0  |
| 2/0 x 6/8  | 2/0 x 8/0  |
| 2/4 x 6/8  | 2/4 x 8/0  |
| 2/6 x 6/8  | 2/6 x 8/0  |
| 2/8 x 6/8  | 2/8 x 8/0  |
| 2/10 x 6/8 | 2/10 x 8/0 |
| 3/0 x 6/8  | 3/0 x 8/0  |



RSP

1/6

**KP66 1-3/8"**  
11/16" Raised Panel,  
Ovolo Sticking

- |            |
|------------|
| 1/6 x 6/8  |
| 2/0 x 6/8  |
| 2/4 x 6/8  |
| 2/6 x 6/8  |
| 2/8 x 6/8  |
| 2/10 x 6/8 |
| 3/0 x 6/8  |

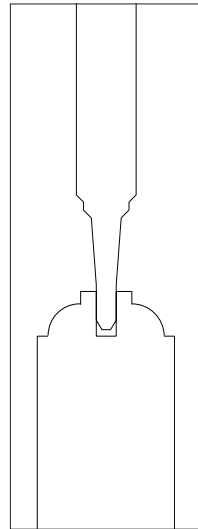

KP22/KP66,  
Ovolo Sticking

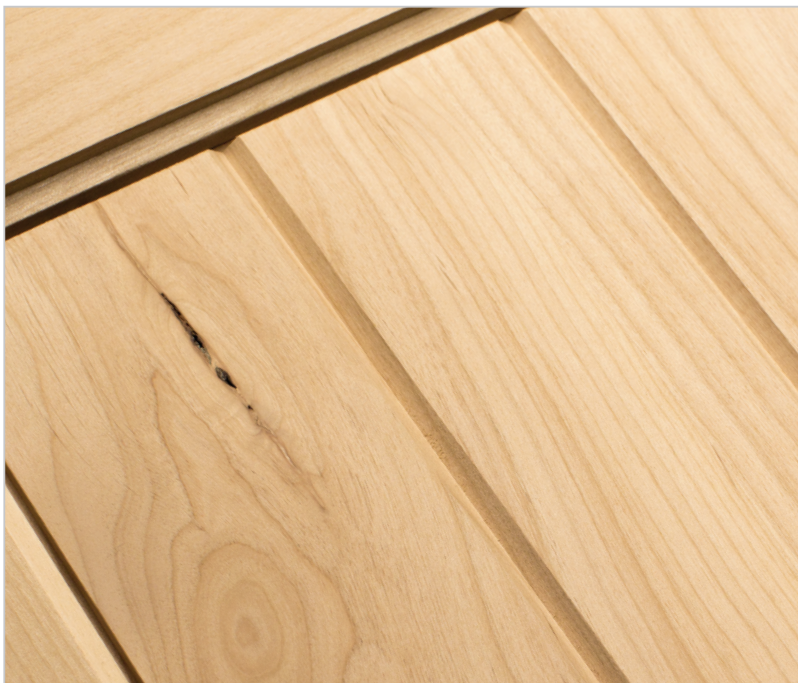

V-Groove Close Up



RSP

**KP22V 1-3/8"**  
11/16" V-Groove Raised Panel,  
Reticulated Sticking and Joint

- |            |            |
|------------|------------|
| 1/6 x 6/8  | 1/6 x 8/0  |
| 2/0 x 6/8  | 2/0 x 8/0  |
| 2/4 x 6/8  | 2/4 x 8/0  |
| 2/6 x 6/8  | 2/6 x 8/0  |
| 2/8 x 6/8  | 2/8 x 8/0  |
| 2/10 x 6/8 | 2/10 x 8/0 |
| 3/0 x 6/8  | 3/0 x 8/0  |

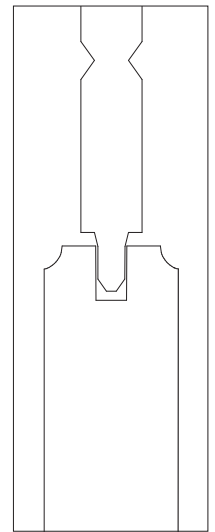

KP22V Reticulated  
Sticking and Joint  
(Shown from above)

# Douglas Fir

## 3/8" FLAT PANEL



Douglas Fir is a large, generally straight-grained tree characterized by exceptional natural strength, hardness and durability. The wood varies in color from yellowish tan to light, bright brown.



3/8" Flat Panel, Ovolo Sticking



Species Close Up



Ovolo Sticking

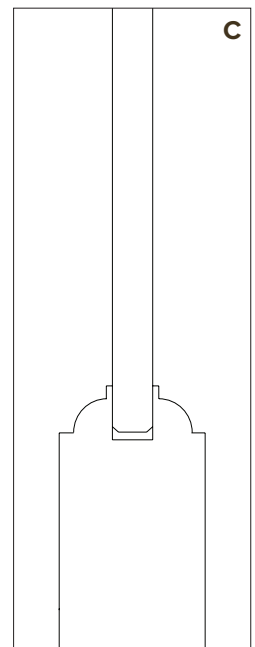
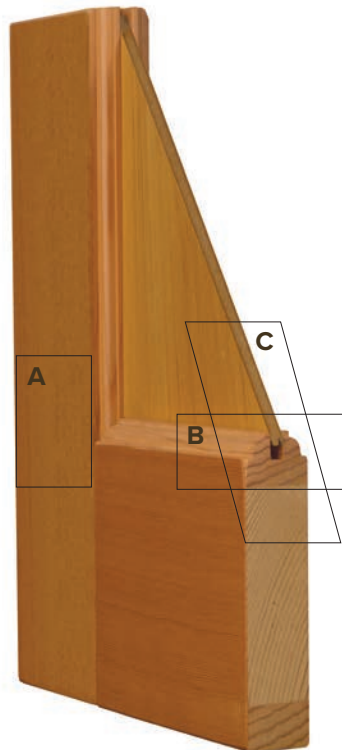

Panel Profile



**OVOLO STICKING**



SMP

**F20 1-3/8"**

3/8" Flat Panel,  
Ovolo Sticking

1/0 x 6/8	2/4 x 6/8	2/0 x 7/0
1/2 x 6/8	2/6 x 6/8	2/4 x 7/0
1/3 x 6/8	2/8 x 6/8	2/6 x 7/0
1/4 x 6/8	3/0 x 6/8	2/8 x 7/0
1/6 x 6/8		3/0 x 7/0
1/8 x 6/8		
2/0 x 6/8		



SMP

**F20 1-3/4"**

3/8" Flat Panel,  
Ovolo Sticking

1/4 x 6/8	2/6 x 6/8	1/4 x 7/0	2/6 x 7/0
1/6 x 6/8	2/8 x 6/8	1/6 x 7/0	2/8 x 7/0
1/8 x 6/8	2/10 x 6/8	1/8 x 7/0	2/10 x 7/0
1/10 x 6/8	3/0 x 6/8	1/10 x 7/0	3/0 x 7/0
2/0 x 6/8		2/0 x 7/0	
2/2 x 6/8		2/2 x 7/0	
2/4 x 6/8		2/4 x 7/0	



SMP

**F82 1-3/8"**

3/8" Flat Panel,  
Ovolo Sticking

1/0 x 6/8	2/4 x 6/8	1/6 x 7/0
1/2 x 6/8	2/6 x 6/8	2/0 x 7/0
1/3 x 6/8	2/8 x 6/8	2/4 x 7/0
1/4 x 6/8	3/0 x 6/8	2/6 x 7/0
1/6 x 6/8		2/8 x 7/0
1/8 x 6/8		3/0 x 7/0
2/0 x 6/8		



SMP

**F82 1-3/4"**

3/8" Flat Panel,  
Ovolo Sticking

2/0 x 6/8	2/0 x 7/0
2/2 x 6/8	2/2 x 7/0
2/4 x 6/8	2/4 x 7/0
2/6 x 6/8	2/6 x 7/0
2/8 x 6/8	2/8 x 7/0
2/10 x 6/8	2/10 x 7/0
3/0 x 6/8	3/0 x 7/0

**MAGNETIC CHALKBOARD**



SMP

**F30 1-3/8"**

3/8" Flat Panel,  
Ovolo Sticking

2/0 x 6/8
2/4 x 6/8
2/6 x 6/8
2/8 x 6/8
3/0 x 6/8



SMP

**F1120 1-3/8"**

Magnetic Chalkboard,  
Ovolo Sticking

2/0 x 6/8
2/4 x 6/8
2/6 x 6/8
2/8 x 6/8
3/0 x 6/8

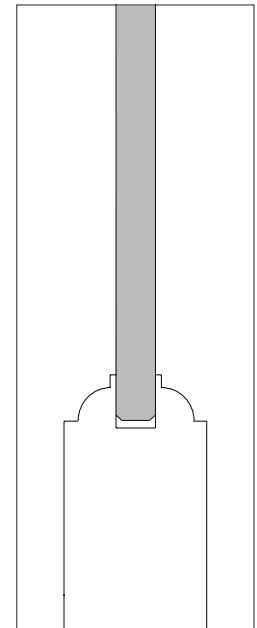

Panel Profile

**Magnetic Chalkboard Paint**

For information about maintenance and finishing, see page 78.

# Douglas Fir

## 3/8" FLAT PANEL



Douglas Fir is a large, generally straight-grained tree characterized by exceptional natural strength, hardness and durability. The wood varies in color from yellowish tan to light, bright brown.



3/8" Flat Panel, Shaker Sticking



Species Close Up



Shaker Sticking

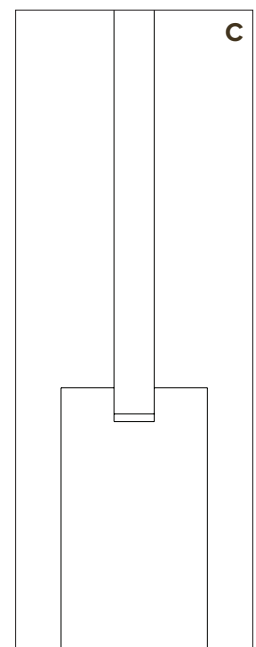
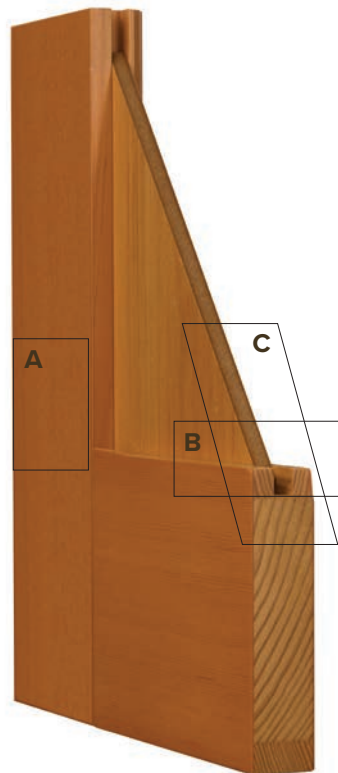

Panel Profile

**SHAKER STICKING**



SMP

**F720 1-3/8"**  
3/8" Flat Panel,  
Shaker Sticking

- 1/6 x 6/8
- 2/0 x 6/8
- 2/4 x 6/8
- 2/6 x 6/8
- 2/8 x 6/8
- 3/0 x 6/8



SMP

**F782 1-3/8"**  
3/8" Flat Panel,  
Shaker Sticking

- 2/0 x 6/8
- 2/4 x 6/8
- 2/6 x 6/8
- 2/8 x 6/8
- 3/0 x 6/8



SMP

**F730 1-3/8"**  
3/8" Flat Panel,  
Shaker Sticking

- 1/6 x 6/8
- 2/0 x 6/8
- 2/4 x 6/8
- 2/6 x 6/8
- 2/8 x 6/8
- 3/0 x 6/8



SMP

**F760 1-3/8"**  
3/8" Flat Panel,  
Shaker Sticking

- 2/0 x 6/8
- 2/4 x 6/8
- 2/6 x 6/8
- 2/8 x 6/8
- 3/0 x 6/8



SMP

**F762 1-3/8"**  
3/8" Flat Panel,  
Shaker Sticking

- 2/0 x 6/8
- 2/4 x 6/8
- 2/6 x 6/8
- 2/8 x 6/8
- 3/0 x 6/8



SMP

**F755 1-3/8"**  
3/8" Flat Panel,  
Shaker Sticking

- 1/6 x 6/8
- 2/0 x 6/8
- 2/4 x 6/8
- 2/6 x 6/8
- 2/8 x 6/8
- 3/0 x 6/8

# Douglas Fir



## DOUBLE HIP RAISED PANEL

Douglas Fir is a large, generally straight-grained tree characterized by exceptional natural strength, hardness and durability. The wood varies in color from yellowish tan to light, bright brown.

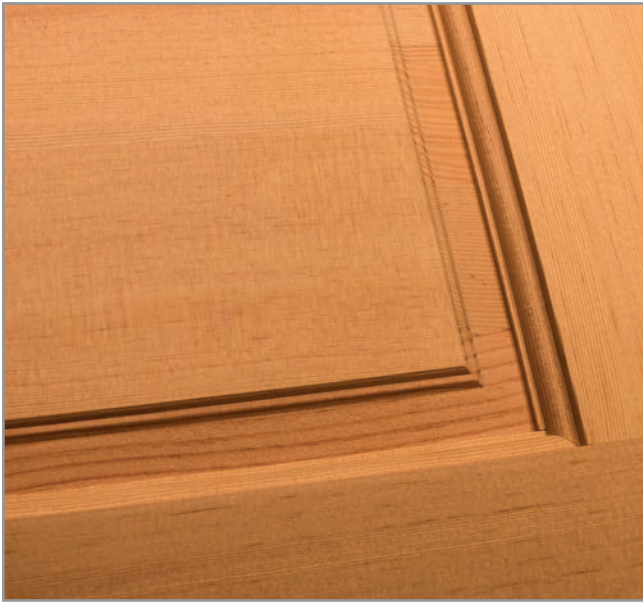

3/4" Double Hip Raised Panel, Ovolo Sticking



1-3/16" Double Hip Raised Panel, Ovolo Sticking

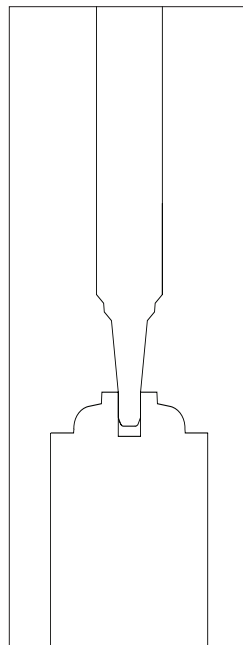

Panel Profile

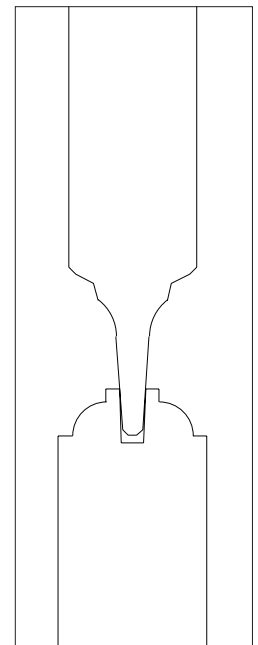

Panel Profile

**3/4" DOUBLE HIP RAISED PANEL**

Bifolds are carton packed with track and hardware.



SMP

**F82R 1-3/8"**  
3/4" Raised Panel,  
Ovolo Sticking

- 1/6 x 6/8
- 2/0 x 6/8
- 2/4 x 6/8
- 2/6 x 6/8
- 2/8 x 6/8
- 3/0 x 6/8



SMP

**F465 1-3/8"**  
3/4" Raised Panel,  
Ovolo Sticking

- 1/6 x 6/8
- 2/0 x 6/8
- 2/4 x 6/8
- 2/6 x 6/8
- 2/8 x 6/8
- 3/0 x 6/8



SMP

1/4 - 1/6

**F44 1-3/8"**  
3/4" Raised Panel,  
Ovolo Sticking

- 1/4 x 6/8
- 1/6 x 6/8
- 2/0 x 6/8
- 2/4 x 6/8
- 2/6 x 6/8
- 2/8 x 6/8
- 2/10 x 6/8
- 3/0 x 6/8



SMP

**F55 1-3/8"**  
3/4" Raised Panel,  
Ovolo Sticking

- 1/6 x 6/8
- 2/0 x 6/8
- 2/4 x 6/8
- 2/6 x 6/8
- 2/8 x 6/8
- 3/0 x 6/8
- 1/6 x 7/0
- 2/0 x 7/0
- 2/4 x 7/0
- 2/6 x 7/0
- 2/8 x 7/0
- 2/10 x 7/0
- 3/0 x 7/0

**1-3/16" DOUBLE HIP RAISED PANEL**



SMP

**F46 1-3/8"**  
3/4" Raised Panel,  
Ovolo Sticking

- 2/4 x 6/8
- 2/6 x 6/8
- 3/0 x 6/8



SMP

1/0 - 1/8

**F66 1-3/8"**  
3/4" Raised Panel,  
Ovolo Sticking

- 1/0 x 6/8
- 1/3 x 6/8
- 1/4 x 6/8
- 1/6 x 6/8
- 1/8 x 6/8
- 2/0 x 6/8
- 2/4 x 6/8
- 2/6 x 6/8
- 2/8 x 6/8
- 3/0 x 6/8



SMP

**F63 1-3/8" BIFOLD**  
3/4" Raised Panel,  
Ovolo Sticking

- 2/0 x 6/8
- 2/6 x 6/8
- 3/0 x 6/8
- 4/0 x 6/8
- 5/0 x 6/8
- 6/0 x 6/8



WG

**F82A 1-3/8"**  
1-3/16" Raised Panel,  
Ovolo Sticking

- 1/6 x 6/8
- 2/0 x 6/8
- 2/4 x 6/8
- 2/6 x 6/8
- 2/8 x 6/8
- 2/10 x 6/8
- 3/0 x 6/8

# Douglas Fir

## FRENCH



Douglas Fir is a large, generally straight-grained tree characterized by exceptional natural strength, hardness and durability. The wood varies in color from yellowish tan to light, bright brown.



Clear Glass, Ovolo Sticking

### CLEAR GLASS

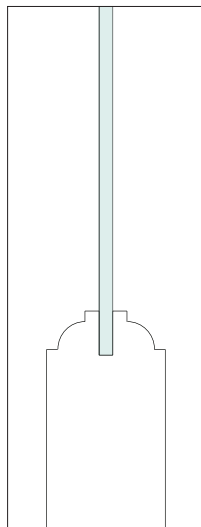

**F1501 1-3/8"**  
Clear Glass, Ovolo Sticking

- 2/0 x 6/8
- 2/4 x 6/8
- 2/6 x 6/8
- 2/8 x 6/8
- 3/0 x 6/8



**F318 1-3/8"**  
3/4" Raised Panel, Clear Glass,  
Ovolo Sticking

- 2/6 x 6/8
- 2/8 x 6/8
- 3/0 x 6/8

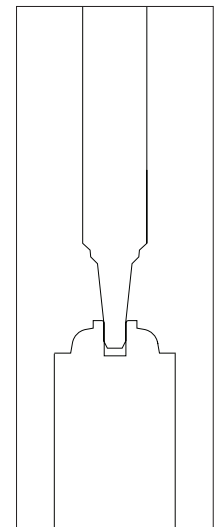

**F418 1-3/8"**  
3/4" Raised Panel, Clear Glass,  
Ovolo Sticking

- 2/8 x 6/8
- 3/0 x 6/8

Panel Profile



White Laminate Glass, Shaker Sticking

**WHITE LAMINATE GLASS**

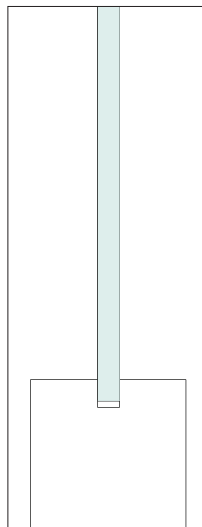

Full Lite Profile

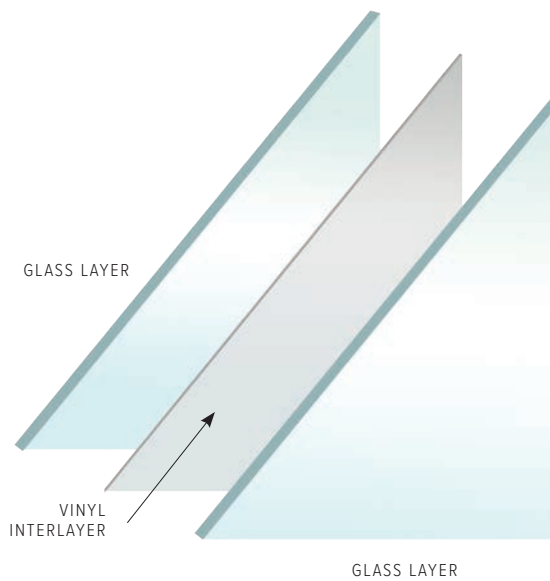

**F1501WL 1-3/8"**  
White Laminate Glass,  
Shaker Sticking

- 2/0 x 6/8
- 2/4 x 6/8
- 2/6 x 6/8
- 2/8 x 6/8
- 3/0 x 6/8

# Douglas Fir

## 1-1/4" BAR



Douglas Fir is a large, generally straight-grained tree characterized by exceptional natural strength, hardness and durability. The wood varies in color from yellowish tan to light, bright brown.



1-1/4" Bar, Clear Glass



1-1/4" Bar, Satin Etch Glass

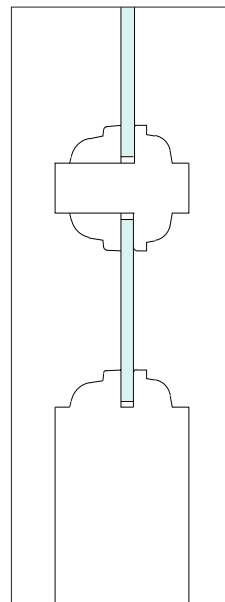

1-1/4" Bar Profile



**CLEAR GLASS**



**F1505 1-3/8"**  
 1-1/4" Bar, Clear Glass  
 2/0 x 6/8  
 2/4 x 6/8  
 2/6 x 6/8  
 2/8 x 6/8  
 3/0 x 6/8



**F1580 1-3/8"**  
 1-1/4" Bar, Clear Glass  
 2/6 x 6/8  
 2/8 x 6/8  
 3/0 x 6/8



**F1309 1-3/8"**  
 1-1/4" Bar, Clear Glass  
 2/6 x 6/8  
 2/8 x 6/8  
 3/0 x 6/8

**SATIN ETCH GLASS**



**F1310 1-3/8"**  
 1-1/4" Bar, Clear Glass  
 2/0 x 6/8



**F1315 1-3/8"**  
 1-1/4" Bar, Clear Glass  
 2/4 x 6/8  
 2/6 x 6/8  
 2/8 x 6/8  
 3/0 x 6/8



**F1505E 1-3/8"**  
 1-1/4" Bar, Satin Etch Glass  
 2/0 x 6/8  
 2/4 x 6/8  
 2/6 x 6/8  
 2/8 x 6/8  
 3/0 x 6/8



**F1510E 1-3/8"**  
 1-1/4" Bar, Satin Etch Glass  
 2/0 x 6/8

# Douglas Fir

## DECORATIVE



Douglas Fir is a large, generally straight-grained tree characterized by exceptional natural strength, hardness and durability. The wood varies in color from yellowish tan to light, bright brown.

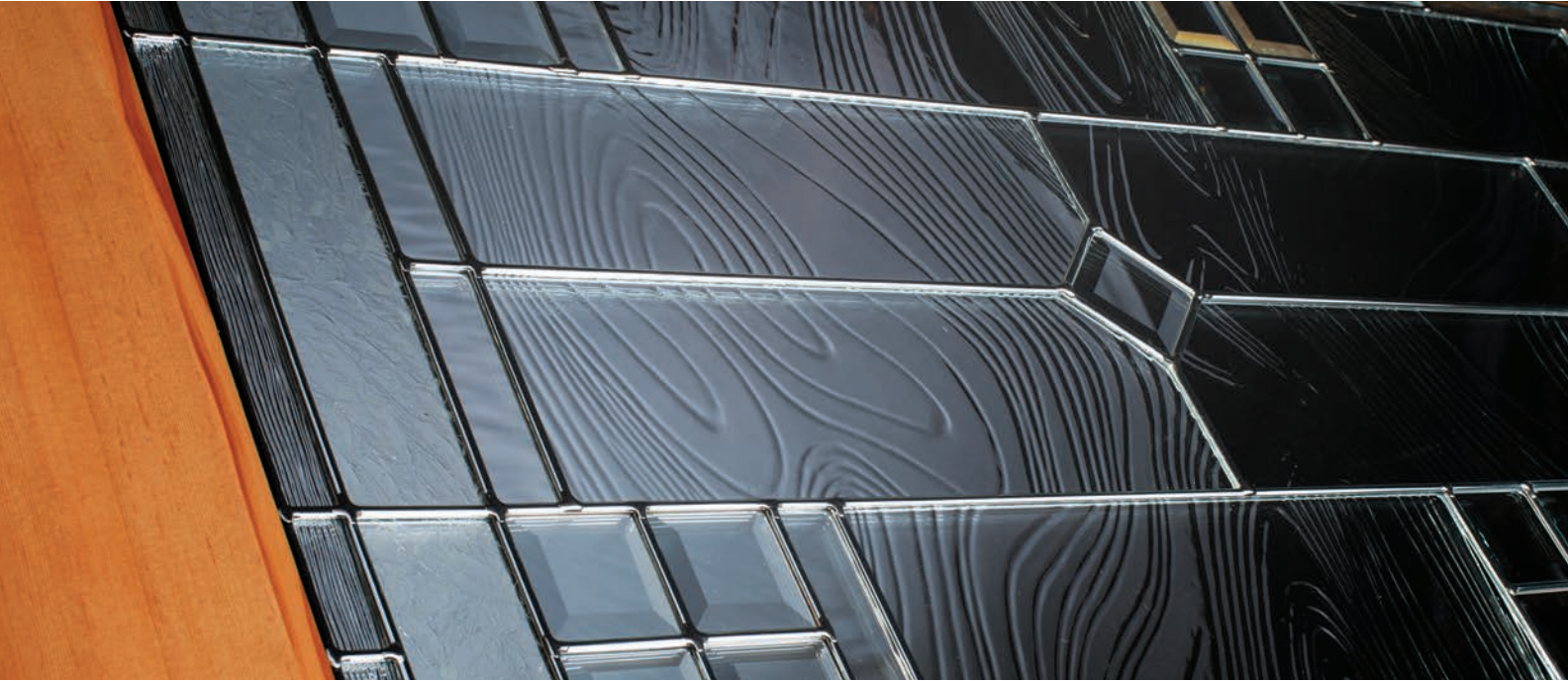

Decorative Glass, Silver Caming



**F1590 1-3/8"**  
Decorative Glass,  
Clear Art on Satin Etch

- 2/0 x 6/8
- 2/6 x 6/8
- 2/8 x 6/8
- 3/0 x 6/8



**F1592 1-3/8"**  
Decorative Glass,  
Clear Art on Satin Etch

- 2/4 x 6/8
- 2/6 x 6/8
- 2/8 x 6/8
- 3/0 x 6/8





**F88405 1-3/8"**  
Decorative Glass,  
Brass Caming

2/6 x 6/8  
2/8 x 6/8  
3/0 x 6/8



**F88421 1-3/8"**  
Decorative Glass,  
Black Caming

2/6 x 6/8  
2/8 x 6/8  
3/0 x 6/8

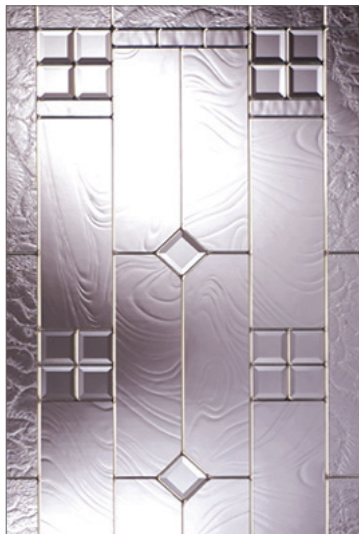

**F88464 1-3/8"**  
Decorative Glass,  
Silver Caming

2/6 x 6/8  
2/8 x 6/8  
3/0 x 6/8

Visit [simpsondoor.com](http://simpsondoor.com) for more information about decorative glass privacy ratings.

# Douglas Fir



## 20 MINUTE FIRE RATED DOORS

Douglas Fir is a large, generally straight-grained tree characterized by exceptional natural strength, hardness and durability. The wood varies in color from yellowish tan to light, bright brown.

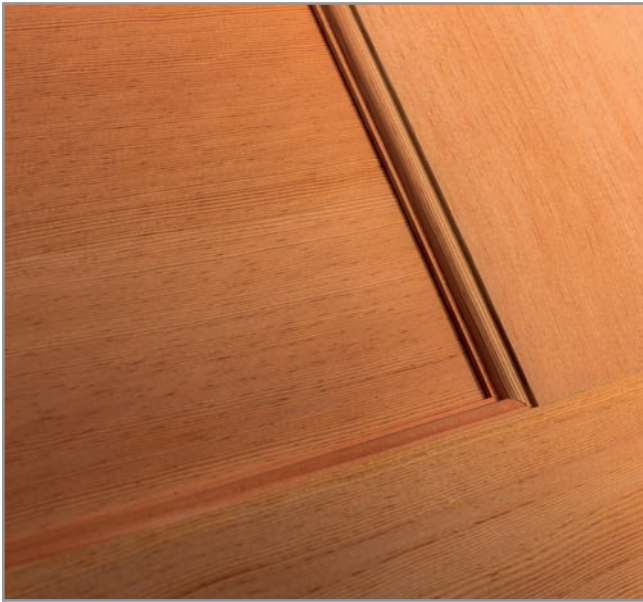

3/4" Fire Rated Flat Panel

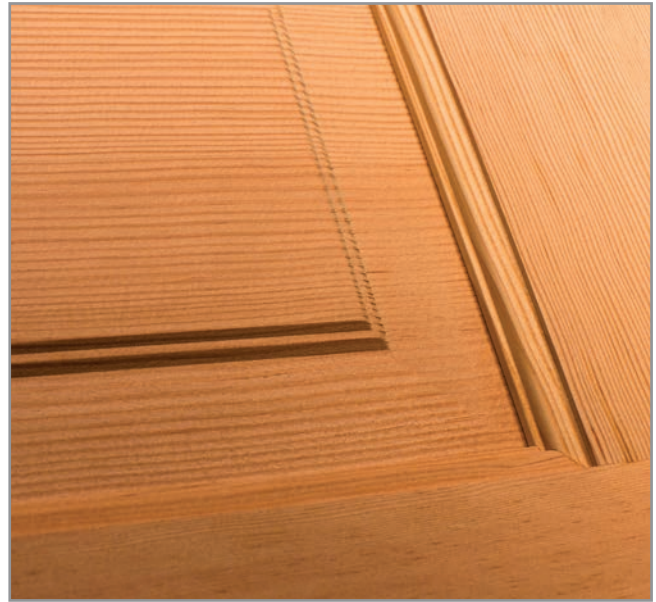

1-7/16" Fire Rated Double Hip Raised Panel

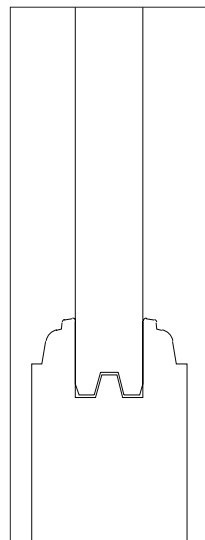

Panel Profile

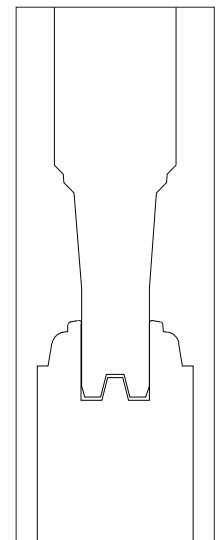

Panel Profile

**3/4" FIRE RATED FLAT PANEL**



**F9220 1-3/4"**  
 3/4" Fire Rated Flat Panel  
 Ovolo Sticking  
 20 Minute Fire Rating  
 2/8 x 6/8  
 3/0 x 6/8



**F9282 1-3/4"**  
 3/4" Fire Rated Flat Panel  
 Ovolo Sticking  
 20 Minute Fire Rating  
 2/8 x 6/8  
 3/0 x 6/8

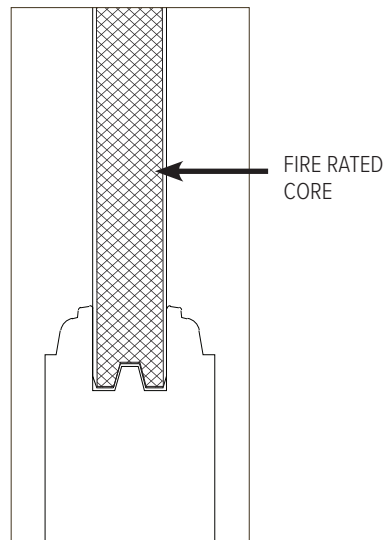

Panel Profile

**1-7/16" FIRE RATED RAISED PANEL**



**F9244 1-3/4"**  
 1-7/16" Fire Rated Raised Panel  
 Ovolo Sticking  
 20 Minute Fire Rating  
 2/8 x 6/8  
 3/0 x 6/8



**F9255 1-3/4"**  
 1-7/16" Fire Rated Raised Panel  
 Ovolo Sticking  
 20 Minute Fire Rating  
 2/8 x 6/8  
 3/0 x 6/8



**F9266 1-3/4"**  
 1-7/16" Fire Rated Raised Panel  
 Ovolo Sticking  
 20 Minute Fire Rating  
 2/8 x 6/8  
 3/0 x 6/8

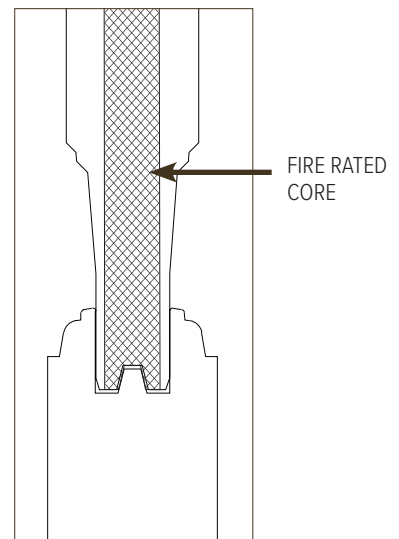

Panel Profile

# Maple

## 3/8" FLAT PANEL



Maple offers a very fine grain and a whitish color tinged with reddish brown.



3/8" Flat Panel, Shaker Sticking

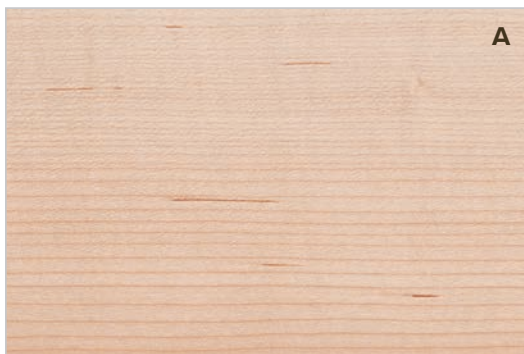

Species Close Up



Shaker Sticking

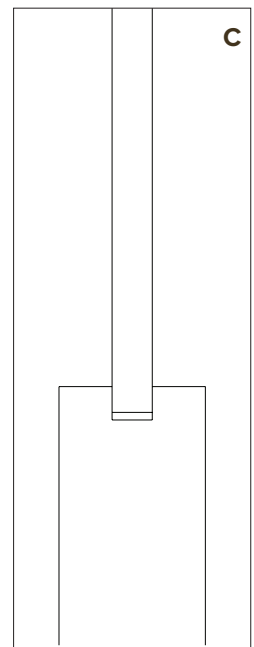
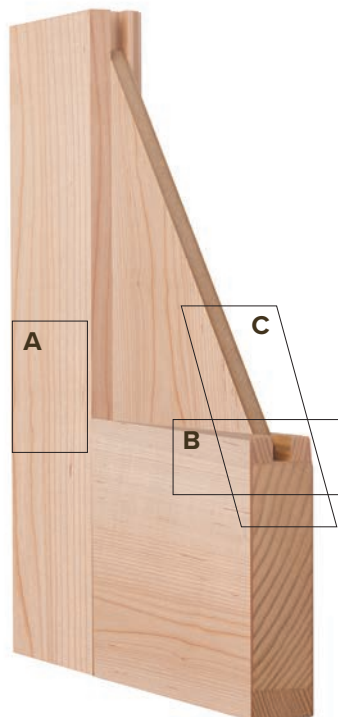

Panel Profile

**3/8" FLAT PANEL**



**SMP**

**MP1022 1-3/8"**

3/8" Flat Panel,  
Shaker Sticking

- 2/0 x 6/8
- 2/4 x 6/8
- 2/6 x 6/8
- 2/8 x 6/8
- 3/0 x 6/8



**SMP**

**MP1033 1-3/8"**

3/8" Flat Panel,  
Shaker Sticking

- 2/0 x 6/8
- 2/4 x 6/8
- 2/6 x 6/8
- 2/8 x 6/8
- 3/0 x 6/8



**MP1033**, Simpson

# Knotty Alder

## 1-3/16" RAISED PANEL



Knotty Alder is a medium density hardwood with an even grain appearance. The wood is normally light brown with hues of red or peach. Its softer nature makes it easy to machine and receptive to a variety of stains and finishes.



V-Groove Plank Raised Panel, Tapered Sticking



Species Close Up



Tapered Sticking

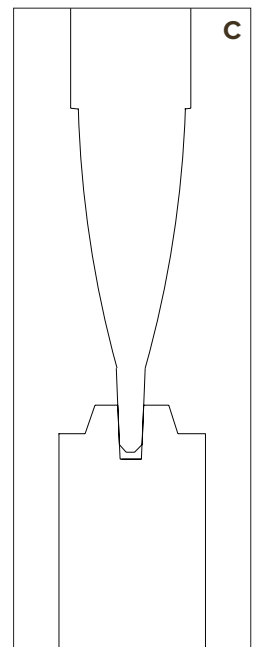
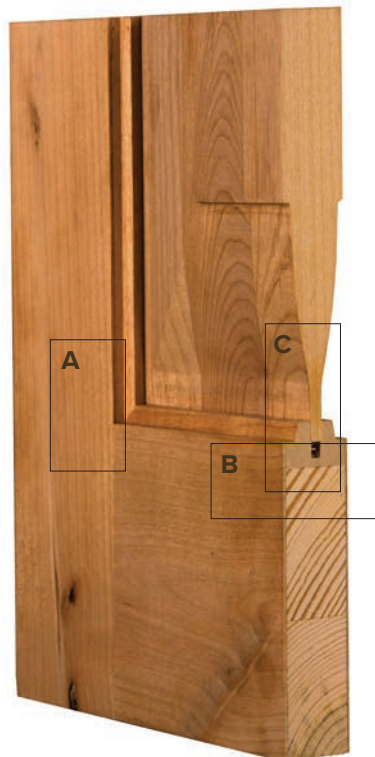

KA82ASRR/KA82SRR  
Tapered Sticking  
(Shown from above)



**1-1/8" V-GROOVE PLANK RAISED PANEL**

**1-3/16" RAISED PANEL**

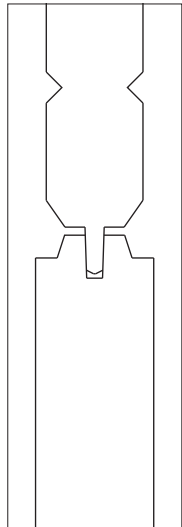

**KA82ASRP 1-3/8"**

1-3/16" V-Groove Plank Raised Panel, Tapered Sticking

- 2/0 x 6/8
- 2/4 x 6/8
- 2/6 x 6/8
- 2/8 x 6/8
- 3/0 x 6/8

KA82ASRP  
Tapered Sticking  
(Shown from above)

**KA82ASRR 1-3/8"**

1-3/16" Raised Panel, Tapered Sticking

- 1/6 x 6/8
- 2/0 x 6/8
- 2/4 x 6/8
- 2/6 x 6/8
- 2/8 x 6/8
- 3/0 x 6/8

**KA82SRR 1-3/8"**

1-3/16" Raised Panel, Tapered Sticking

- 1/6 x 6/8
- 2/0 x 6/8
- 2/4 x 6/8
- 2/6 x 6/8
- 2/8 x 6/8
- 3/0 x 6/8



# Red Oak

## 3/4" RAISED PANEL



Red Oak has a coarse texture and a straight, prominent grain. It accepts a broad range of stains and finishes.



Red Oak, 3/4" Double Hip Raised Panel

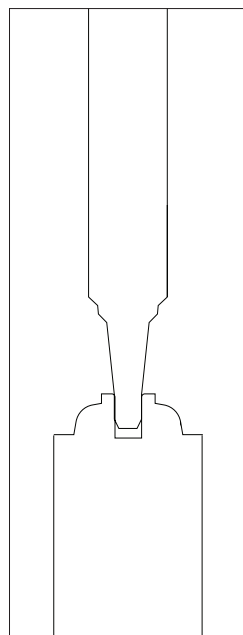

Panel Profile

**RED OAK, DOUBLE HIP RAISED PANEL**

Bifolds are carton packed with track and hardware.



**O44 1-3/8"**  
3/4" Raised Panel,  
Ovolo Sticking

- 1/6 x 6/8
- 2/0 x 6/8
- 2/4 x 6/8
- 2/6 x 6/8
- 2/8 x 6/8
- 3/0 x 6/8



**O66 1-3/8"**  
3/4" Raised Panel,  
Ovolo Sticking

- 1/6 x 6/8
- 2/0 x 6/8
- 2/4 x 6/8
- 2/6 x 6/8
- 2/8 x 6/8
- 3/0 x 6/8



**O66 1-3/8" BIFOLD**  
3/4" Raised Panel,  
Ovolo Sticking

- 2/0 x 6/8
- 2/6 x 6/8
- 3/0 x 6/8
- 4/0 x 6/8
- 5/0 x 6/8
- 6/0 x 6/8



**O66**, Simpson

# Red Oak

## FRENCH - 1-1/4" BAR



Red Oak has a coarse texture and a straight, prominent grain. It accepts a broad range of stains and finishes.



1-1/4" Bar, Clear Glass



1-1/4" Bar Close Up

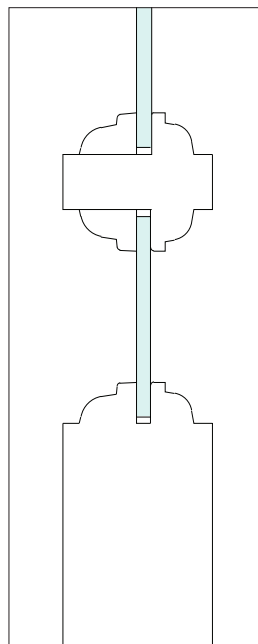

1-1/4" Bar Profile



O1315, Simpson

1-1/4" BAR

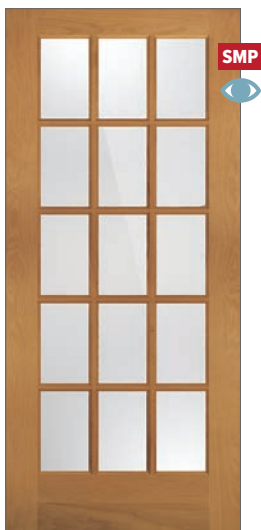

**O1315 1-3/8"**  
 1-1/4" Bar, Clear Glass  
 2/6 x 6/8  
 2/8 x 6/8  
 3/0 x 6/8



**O1310 1-3/8"**  
 1-1/4" Bar, Clear Glass  
 2/0 x 6/8

# Barn Doors

PONDEROSA PINE - TRUE RAISED PANEL



P180, Woodgrain



**P180**

True Raised Panel

- 2/6 x 6/8    2/6 x 7/0    2/6 x 8/0
- 2/8 x 6/8    2/8 x 7/0    2/8 x 8/0
- 3/0 x 6/8    3/0 x 7/0    3/0 x 8/0



**P181**

True Raised Panel

- 2/6 x 6/8    2/6 x 7/0    2/6 x 8/0
- 2/8 x 6/8    2/8 x 7/0    2/8 x 8/0
- 3/0 x 6/8    3/0 x 7/0    3/0 x 8/0

Barn doors can be hung in many different configurations according to your design preference. Please be sure to specify when ordering.

**Layout Options**

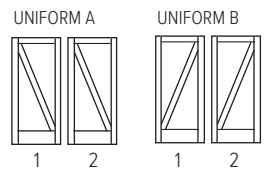
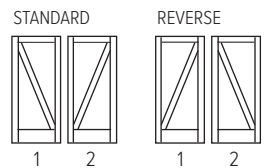

# Barn Doors

KNOTTY ALDER - TRUE RAISED PANEL



KA181, Woodgrain

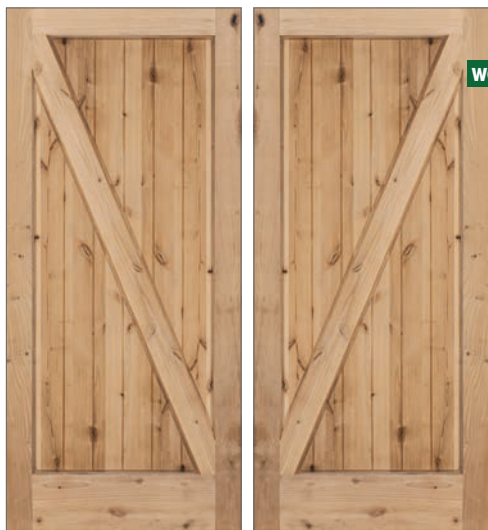

## KA180

True Raised Panel

2/6 x 6/8   2/6 x 7/0   2/6 x 8/0  
 2/8 x 6/8   2/8 x 7/0   2/8 x 8/0  
 3/0 x 6/8   3/0 x 7/0   3/0 x 8/0

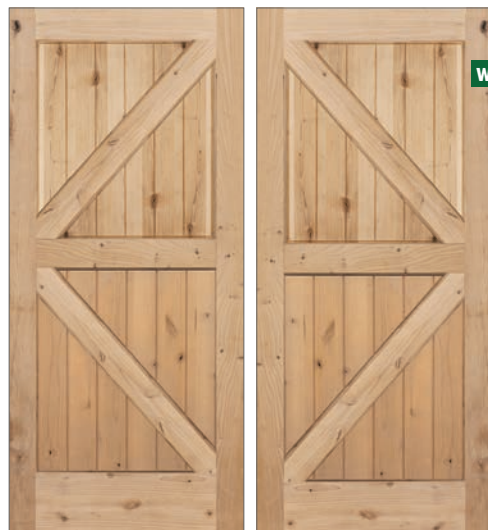

## KA181

True Raised Panel

2/6 x 6/8   2/6 x 7/0   2/6 x 8/0  
 2/8 x 6/8   2/8 x 7/0   2/8 x 8/0  
 3/0 x 6/8   3/0 x 7/0   3/0 x 8/0

Barn doors can be hung in many different configurations according to your design preference. Please be sure to specify when ordering.

### Layout Options

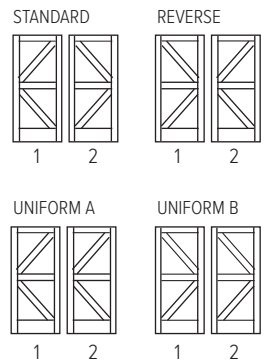

# Barn Door Hardware



Goldberg's line of interior, residential sliding barn door hardware kits make the most of the available living space, while adding a rustic, yet elegant look. All major components are manufactured from steel and come with a 1-year warranty.

For a more polished or contemporary look, solid stainless steel barn door track hardware is a great alternative. All the same accessories are available as well for a complete look.

## HARDWARE OPTIONS (shown in black)

## HARDWARE OPTIONS (shown in stainless steel)



ROLLER HANGER

7" PULL HANDLE

6" FLUSH PULL

PRIVACY LATCH

ROLLER HANGER

7" PULL HANDLE

6" FLUSH PULL

PRIVACY LATCH

## AVAILABLE FINISHES

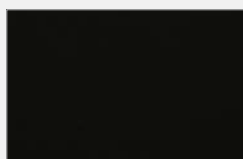

Black

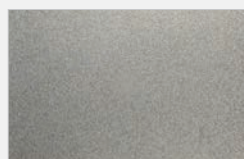

Silver

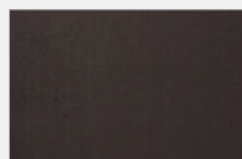

Architectural Bronze

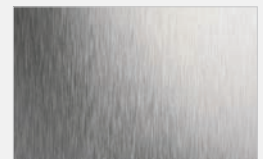

Stainless Steel





Because of the wall space required for the long track, sometimes there's no room to install a conventional barn door. Barnfold® Series folding barn door hardware combines the style of the popular J-strap hangers with the space-saving convenience of bifold doors.

**INCLUDED  
HARDWARE**



BARNFOLD J-STRAP  
HANGER



HINGE



4" PULL HANDLE

**AVAILABLE  
FINISHES**

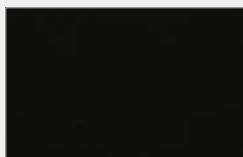

Black

# Flat Frames



## Flat Frames

Flat frames come in a variety of species including solid and veneered wood. They include the need for a stop. This option may not be available in all markets so please confirm availability prior to ordering.



PRIMED



CLEAR PINE



PINE VENEERED



KNOTTY ALDER VENEERED



FIR VENEERED



MAPLE VENEERED



SOLID POPLAR



PRIMED SOLID POPLAR



SOLID OAK



OAK VENEERED

---

## Stops

Known as a “stop”, these small pieces of wood attach to a flat frame to give the door a place to stop. Optional Portaseal weatherstripped stops are available for use to prevent drafts.



PRIMED WM-888



PRIMED WM-876



PRIMED WM-888H



PRIMED WM-936



PRIMED WM-948



PORTASEAL WEATHERSTRIP

# Rabbeted Frames



## Single Rabbeted

Single rabbeted frames mimic the appearance of exterior frames for interior use. This option may not be available in all markets so please confirm availability prior to ordering.



PRIMED



CLEAR PINE



PRIMED SOLID POPLAR



## Double Rabbeted

Double rabbeted frames work well with either a 1-3/8" or 1-3/4" thick door. This option may not be available in all markets so please confirm availability prior to ordering.



PRIMED



CLEAR PINE



PRIMED SOLID POPLAR

# Split Frames

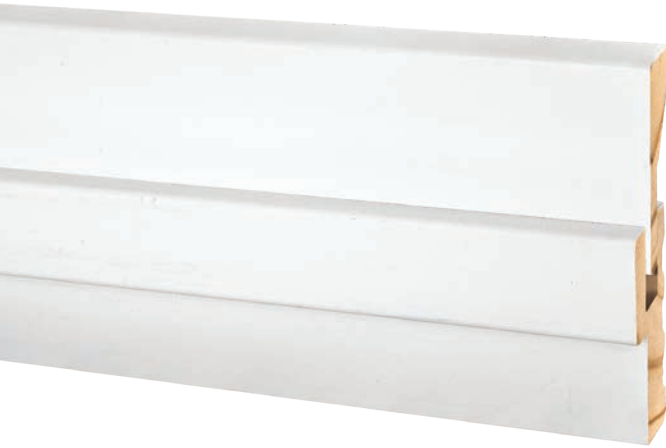

## Split

Split frames are two pieces of wood together which work well for odd wall sizes. This option may not be available in all markets so please confirm availability prior to ordering.



PRIMED



CLEAR PINE

Because of their construction, a split frame is able to work for a range of wall sizes. For example, Reeb® stocks a split frame that has a size range of 4-1/2" to 5-1/4" thick.

Also with split frames is the availability to use interior casing. When installing a split frame with casing, the two pieces must be taken apart. This allows Reeb to ship the unit with the casing pre-attached and ready for a complete install. This option may not be available in all markets so please confirm availability prior to ordering.

---

# Sills



OAK SADDLE SILL

Oak saddle sills provide an aesthetic solution to residential threshold applications. If the unit does not include weatherstrip, a standard width saddle sill works well.



OAK SADDLE SILL WITH WEATHERSTRIP

For flat frames with portoseal or single rabbeted frames with weatherstrip, a wider saddle sill works best. It allows the bottom of the frame to sit flush on top of the sill. Three sided units do not need a sweep, but a four-sided unit will use a sweep for the best seal.

# Hinges

## BALL BEARING HINGES

Ball bearing hinges have a steel ball bearing, or buffer, in between the knuckles. Heavier doors put more stress on the hinges, so having the ball bearings reduces friction leading to better performance and longevity.



Ball Bearing Square



Ball Bearing Radius

## NON BALL BEARING HINGES

Standard, or plain bearing, have no buffer between each knuckle of the barrel. This tends to wear the hinge down over time as the sections grind against one another and are better suited for lightweight doors.



Non Ball Bearing Square



Non Ball Bearing Radius

## HINGE SIZES

Most interior doors are 1-3/8" thick and use 3.5" x 3.5" hinges. On an 1-3/4" door in an interior application Reeb® will automatically utilize a 4" hinge.



3.5" x 3.5"



4" x 4"

# Baldwin®

Baldwin® believes that quality should never be a compromise. From using the finest materials to crafting hardware by hand, they are committed to creating high-quality hardware that not only looks beautiful and flawless, but also endures the rigors of time.



3.5" X 3.5" SQUARE  
Non Ball Bearing - Shown in US3LF



3.5" X 3.5" RADIUS  
Non Ball Bearing - Shown in US3LF



4" X 4" SQUARE  
Ball Bearing - Shown in US15



4" X 4" RADIUS  
Non Ball Bearing - Shown in US3LF

AVAILABLE FINISHES	3.5" X 3.5" SQUARE		3.5" X 3.5" RADIUS		4" X 4" SQUARE		4" X 4" RADIUS	
	BALL BEARING	NON BALL BEARING	BALL BEARING	NON BALL BEARING	BALL BEARING	NON BALL BEARING	BALL BEARING	NON BALL BEARING
<b>US3LF</b>		X		X		X		X
<b>US10B</b>		X		X		X		
<b>US15</b>		X		X		X		
<b>VB</b>		X				X		

## AVAILABLE FINISHES



**US3LF**  
BRIGHT BRASS  
LIFETIME

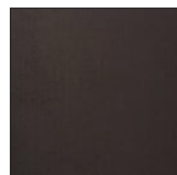

**US10B**  
OIL RUBBED  
BRONZE



**US15**  
SATIN NICKEL

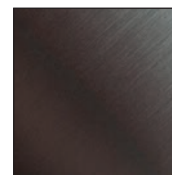

**VB**  
VENETIAN BRONZE

# Hinges

Emtek®

Emtek® is dedicated to bring personal style to life. Door hardware is more than a way to open, close, and secure a space. It is an integral part of a room's design theme and an extension of personal style.



3.5" X 3.5" SQUARE  
Ball Bearing - Shown in US26



3.5" X 3.5" RADIUS  
Non Ball Bearing - Shown in US7



4" X 4" SQUARE  
Ball Bearing - Shown in US15

AVAILABLE FINISHES	3.5" X 3.5" SQUARE		3.5" X 3.5" RADIUS		4" X 4" SQUARE	
	BALL BEARING	NON BALL BEARING	BALL BEARING	NON BALL BEARING	BALL BEARING	NON BALL BEARING
US1D		X	X		X	X
US3		X	X	X	X	X
US7		X	X	X	X	X
US10B		X	X	X	X	X
US15		X	X	X	X	X
US14		X	X		X	X
US26		X			X	X

## AVAILABLE FINISHES

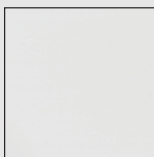

USP  
PRIMED WHITE

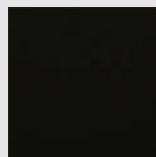

US1D  
FLAT BLACK

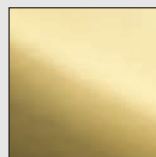

US3  
BRIGHT BRASS

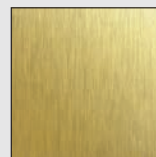

US4  
SATIN BRASS



US4B  
BRIGHT SATIN  
BRASS

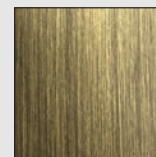

US5  
ANTIQUE BRASS

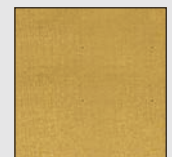

US7  
FRENCH  
ANTIQUE



# Reeb® Specialty Products

RSP offers a large selection of hinges in a variety of finishes carrying on a tradition of innovative design, superior quality and service excellence.



3.5" X 3.5" SQUARE  
Ball Bearing - Shown in US4



3.5" X 3.5" RADIUS  
Non Ball Bearing - Shown in USP



4" X 4" SQUARE  
Non Ball Bearing - Shown in US10B



4" X 4" RADIUS  
Ball Bearing - Shown in US15

AVAILABLE FINISHES	3.5" X 3.5" SQUARE		3.5" X 3.5" RADIUS		4" X 4" SQUARE		4" X 4" RADIUS	
	BALL BEARING	NON BALL BEARING	BALL BEARING	NON BALL BEARING	BALL BEARING	NON BALL BEARING	BALL BEARING	NON BALL BEARING
<b>USP</b>				X				X
<b>US1D</b>		X	X	X		X	X	X
<b>US3</b>	X	X	X	X	X	X	X	X
<b>US4</b>	X	X		X	X	X		X
<b>US4B</b>	X		X	X	X		X	X
<b>US5</b>	X	X	X	X	X	X	X	X
<b>US7</b>								
<b>US10B</b>	X	X	X	X	X	X	X	X
<b>US15</b>	X	X	X	X	X	X	X	X
<b>US15A</b>				X				X
<b>US26</b>	X	X	X	X	X	X	X	X
<b>US26D</b>	X	X	X	X	X	X	X	X
<b>US32D</b>				X			X	X

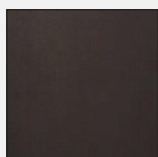

**US10B**  
OIL RUBBED  
BRONZE

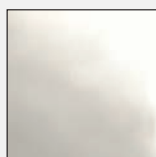

**US14**  
POLISHED  
NICKEL



**US15**  
SATIN NICKEL

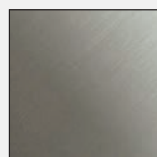

**US15A**  
ANTIQUÉ NICKEL

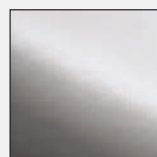

**US26**  
BRIGHT CHROME



**US26D**  
SATIN CHROME



**US32D**  
STAINLESS STEEL

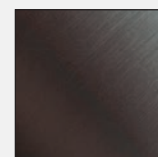

**VB**  
VENETIAN BRONZE

# Locks

Schlage® door knobs fit and accentuate decor from a classic look to bold contemporary designs.

For available functions, reference the Reeb® In-Stock Price Catalog.

The **Standard Residential Series** provides tough, reliable performance in a variety of styles and finishes.

The **Builders Series** provides an economical lock that delivers on style.

## STANDARD RESIDENTIAL SERIES

### Accent

Shown in Bright Chrome



Lockset available in:



**US3**  
BRIGHT BRASS



**US5**  
ANTIQUÉ BRASS



**US15**  
SATIN NICKEL

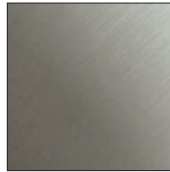

**US15A**  
ANTIQUÉ NICKEL

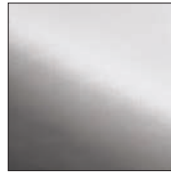

**US26**  
BRIGHT CHROME

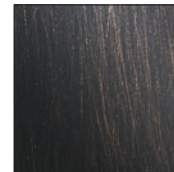

**716**  
AGED BRONZE

### Flair

Shown in US5



Lockset available in:



**US3**  
BRIGHT BRASS

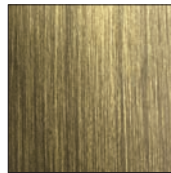

**US5**  
ANTIQUÉ BRASS



**US15**  
SATIN NICKEL

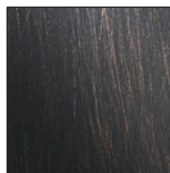

**716**  
AGED BRONZE

### Jazz

Shown in US15



Lockset available in:



**US15**  
SATIN NICKEL

## LaSalle

Shown in US3



Lockset available in:



**US3**  
BRIGHT BRASS



**US15**  
SATIN NICKEL

## Dover

Shown in US32D



Lockset available in:



**US32D**  
STAINLESS STEEL

## Torino

Shown in US3



Lockset available in:



**US3**  
BRIGHT BRASS

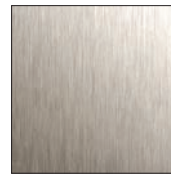

**US15**  
SATIN NICKEL

## Marin

Shown in US32D



Lockset available in:

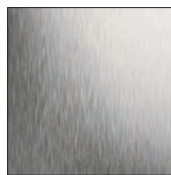

**US32D**  
STAINLESS STEEL

# Locks

STANDARD RESIDENTIAL SERIES

## Plymouth

Shown in US26D



Lockset available in:



**US3**  
BRIGHT BRASS



**US15**  
SATIN NICKEL



**US26**  
BRIGHT CHROME



**US26D**  
SATIN CHROME

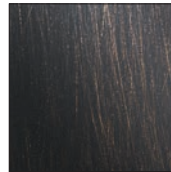

**716**  
AGED BRONZE

## Georgian

Shown in US5



Lockset available in:



**US3**  
BRIGHT BRASS

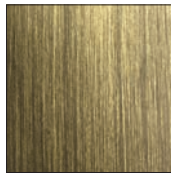

**US5**  
ANTIQUE BRASS



**US15**  
SATIN NICKEL



**US15A**  
ANTIQUE NICKEL

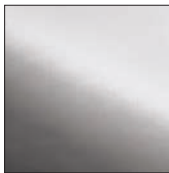

**US26**  
BRIGHT CHROME

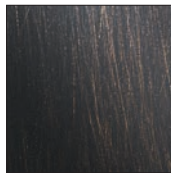

**716**  
AGED BRONZE

## Andover

Shown in US26



Lockset available in:



**US3**  
BRIGHT BRASS

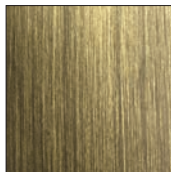

**US5**  
ANTIQUE BRASS



**US15**  
SATIN NICKEL

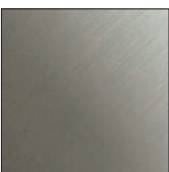

**US15A**  
ANTIQUE NICKEL

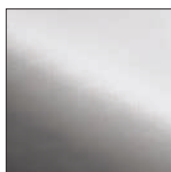

**US26**  
BRIGHT CHROME



**US26D**  
SATIN CHROME

# Byron

Shown in US3



Lockset available in:



**US3**  
BRIGHT BRASS



**US32D**  
STAINLESS STEEL

# Corona

Shown in US15



Lockset available in:



**US3**  
BRIGHT BRASS

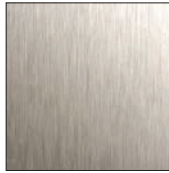

**US15**  
SATIN NICKEL

The **Standard Residential Series** features a limited lifetime mechanical warranty, has a limited lifetime finish warranty, fits universal backsets, and all levers are non-handed.



The **Builders Series** features a limited lifetime mechanical warranty, a 5-year limited finish warranty, and fits universal backsets.



# Stile & Rail Dimensions

DOOR STYLE	PAGE	DOOR HEIGHT	SPECIES	3'0" STILE	TOP RAIL	LOCK RAIL	BOTTOM RAIL	PANEL	VENDOR
KA180	55	6/8	KNOTTY ALDER	4-11/32"	4-9/16"	N/A	9"	3/4"	WOODGRAIN
KA180	55	7/0	KNOTTY ALDER	4-11/32"	4-9/16"	N/A	9"	3/4"	WOODGRAIN
KA180	55	8/0	KNOTTY ALDER	4-11/32"	4-9/16"	N/A	9"	3/4"	WOODGRAIN
KA181	55	6/8	KNOTTY ALDER	4-11/32"	4-9/16"	4-9/16"	9"	3/4"	WOODGRAIN
KA181	55	7/0	KNOTTY ALDER	4-11/32"	4-9/16"	4-9/16"	9"	3/4"	WOODGRAIN
KA181	55	8/0	KNOTTY ALDER	4-11/32"	4-9/16"	4-9/16"	9"	3/4"	WOODGRAIN
P180	54	6/8	PONDEROSA PINE	4-11/32"	4-9/16"	N/A	9"	11/16"	WOODGRAIN
P180	54	7/0	PONDEROSA PINE	4-11/32"	4-9/16"	N/A	9"	11/16"	WOODGRAIN
P180	54	8/0	PONDEROSA PINE	4-11/32"	4-9/16"	N/A	9"	11/16"	WOODGRAIN
P181	54	6/8	PONDEROSA PINE	4-11/32"	4-9/16"	4-9/16"	9"	11/16"	WOODGRAIN
P181	54	7/0	PONDEROSA PINE	4-11/32"	4-9/16"	4-9/16"	9"	11/16"	WOODGRAIN
P181	54	8/0	PONDEROSA PINE	4-11/32"	4-9/16"	4-9/16"	9"	11/16"	WOODGRAIN
F20	33	6/8	FIR	4-1/2"	4-7/16"	N/A	9-3/16"	3/8"	SIMPSON
F20	33	7/0	FIR	4-1/2"	6-7/16"	N/A	11-3/16"	3/8"	SIMPSON
F20 1-3/4"	33	6/8	FIR	4-1/2"	4-7/16"	N/A	9-3/16"	3/8"	SIMPSON
F20 1-3/4"	33	7/0	FIR	4-1/2"	6-7/16"	N/A	11-3/16"	3/8"	SIMPSON
F30	33	6/8	FIR	4-1/2"	4-7/16"	4-1/2"	9-3/16"	3/8"	SIMPSON
F44	37	6/8	FIR	4-1/2"	4-7/16"	7-1/2"	9-3/16"	3/4"	SIMPSON
F46	37	6/8	FIR	4-1/2"	4-7/16"	7-1/2"	9-3/16"	3/4"	SIMPSON
F55	37	6/8	FIR	4-1/2"	4-7/16"	4-1/2"	9-3/16"	3/4"	SIMPSON
F55	37	7/0	FIR	4-1/2"	6-7/16"	4-1/2"	11-3/16"	3/4"	SIMPSON
F63 BIFOLD	37	6/8	FIR	2-1/16"	4-7/16"	7-1/2"	7-7/8"	3/4"	SIMPSON
F66	37	6/8	FIR	4-1/2"	4-7/16"	7-1/2"	9-1/8"	3/4"	SIMPSON
F82R	37	6/8	FIR	4-1/2"	4-7/16"	7-1/2"	9-3/16"	3/4"	SIMPSON
F82	33	6/8	FIR	4-1/2"	4-7/16"	7-1/2"	9-3/16"	3/8"	SIMPSON
F82	37	7/0	FIR	4-1/2"	6-7/16"	7-1/2"	11-3/16"	3/8"	SIMPSON
F82 1-3/4"	37	6/8	FIR	4-1/2"	4-7/16"	7-1/2"	9-3/16"	3/8"	SIMPSON
F82 1-3/4"	37	7/0	FIR	4-1/2"	6-9/16"	7-1/2"	11-3/16"	3/8"	SIMPSON
F82A *	37	6/8	FIR	4-17/32"	8-3/64"	7-1/2"	9"	1-1/8"	WOODGRAIN
F318	38	6/8	FIR	4-1/2"	4-7/16"	4-1/2"	9-3/16"	3/4"	SIMPSON
F418	38	6/8	FIR	4-1/2"	4-7/16"	4-1/2"	9-3/16"	3/4"	SIMPSON
F465 *	37	6/8	FIR	4-1/2"	9-1/2"	7-1/2"	9-3/16"	3/4"	SIMPSON
F720	35	6/8	FIR	4-7/16"	4-5/16"	N/A	9-3/16"	3/8"	SIMPSON
F730	35	6/8	FIR	4-7/16"	4-5/16"	N/A	9-3/16"	3/8"	SIMPSON
F755	35	6/8	FIR	4-7/16"	4-5/16"	N/A	9-3/16"	3/8"	SIMPSON
F760	35	6/8	FIR	4-7/16"	4-5/16"	N/A	9-3/16"	3/8"	SIMPSON
F762	35	6/8	FIR	4-7/16"	4-5/16"	N/A	9-3/16"	3/8"	SIMPSON
F782	35	6/8	FIR	4-7/16"	4-5/16"	7-3/8"	9-3/16"	3/8"	SIMPSON
F1120	33	6/8	FIR	4-1/2"	4-7/16"	N/A	9-3/16"	1/4"	SIMPSON
F1309	41	6/8	FIR	5-1/2"	4-7/16"	N/A	9-3/16"	N/A	SIMPSON
F1310	41	6/8	FIR	4-1/2"	4-7/16"	N/A	9-3/16"	N/A	SIMPSON
F1315	41	6/8	FIR	4-1/2"	4-7/16"	N/A	9-3/16"	N/A	SIMPSON
F1501	38	6/8	FIR	4-1/2"	4-7/16"	N/A	9-3/16"	N/A	SIMPSON
F1501WL	39	6/8	FIR	4-1/2"	4-7/16"	N/A	9-3/16"	N/A	SIMPSON

DOOR STYLE	PAGE	DOOR HEIGHT	SPECIES	3'0" STILE	TOP RAIL	LOCK RAIL	BOTTOM RAIL	PANEL	VENDOR
F1505	41	6/8	FIR	4-1/2"	4-7/16"	N/A	9-3/16"	N/A	SIMPSON
F1505E	41	6/8	FIR	4-1/2"	4-7/16"	N/A	9-3/16"	N/A	SIMPSON
F1510E	41	6/8	FIR	4-1/2"	4-7/16"	N/A	9-3/16"	N/A	SIMPSON
F1580 *	41	6/8	FIR	4-1/2"	7-1/32"	N/A	9-3/16"	N/A	SIMPSON
F1590	42	6/8	FIR	4-1/2"	4-7/16"	N/A	9-3/16"	N/A	SIMPSON
F1592	42	6/8	FIR	4-1/2"	4-7/16"	N/A	9-3/16"	N/A	SIMPSON
F9220 1-3/4"	45	6/8	FIR	5-1/2"	5-7/16"	N/A	9-3/16"	3/4"	SIMPSON
F9282 1-3/4"	45	6/8	FIR	5-1/2"	5-7/16"	7-1/2"	9-3/16"	3/4"	SIMPSON
F9244 1-3/4"	45	6/8	FIR	5-1/2"	5-7/16"	7-1/2"	9-3/16"	1-7/16"	SIMPSON
F9255 1-3/4"	45	6/8	FIR	5-1/2"	5-7/16"	N/A	9-3/16"	1-7/16"	SIMPSON
F9266 1-3/4"	45	6/8	FIR	5-1/2"	5-7/16"	7-1/2"	9-3/16"	1-7/16"	SIMPSON
F88405	43	6/8	FIR	4-1/2"	4-7/16"	N/A	9-7/16"	N/A	SIMPSON
F88421	43	6/8	FIR	4-1/2"	4-7/16"	N/A	9-7/16"	N/A	SIMPSON
F88464	43	6/8	FIR	4-1/2"	4-7/16"	N/A	9-7/16"	N/A	SIMPSON
IP22V *	21	6/8	PLANTATION PINE	4-9/16"	6-5/16"	7-1/2"	9-1/8"	11/16"	RSP
IP22V *	21	8/0	PLANTATION PINE	4-9/16"	6-5/16"	7-1/2"	9-1/8"	11/16"	RSP
IP44	21	6/8	PLANTATION PINE	4-9/16"	4-1/2"	7-1/2"	9-1/8"	11/16"	RSP
IP44	21	8/0	PLANTATION PINE	4-9/16"	4-1/2"	7-1/2"	9-1/8"	11/16"	RSP
IP44 BIFOLD	21	6/8	PLANTATION PINE	2-1/8"	4-1/2"	7-1/2"	8-1/8"	11/16"	RSP
IP55	23	6/8	PLANTATION PINE	4-17/32"	4-9/16"	N/A	9-1/8"	9/16"	RSP
IP56	23	8/0	PLANTATION PINE	4-17/32"	4-9/16"	N/A	9-1/8"	9/16"	RSP
IP66	21	6/8	PLANTATION PINE	4-9/16"	4-1/2"	7-1/2"	9-1/8"	11/16"	RSP
IP66	21	8/0	PLANTATION PINE	4-9/16"	4-1/2"	7-1/2"	9-1/8"	11/16"	RSP
IP66 BIFOLD	21	6/8	PLANTATION PINE	2-1/8"	4-1/2"	N/A	8-1/8"	11/16"	RSP
IP82	23	6/8	PLANTATION PINE	4-17/32"	4-9/16"	N/A	9"	9/16"	RSP
IP82	23	8/0	PLANTATION PINE	4-17/32"	4-9/16"	N/A	9"	9/16"	RSP
IP82A	23	6/8	PLANTATION PINE	4-17/32"	4-9/16"	N/A	9"	9/16"	RSP
IP82A	23	8/0	PLANTATION PINE	4-17/32"	4-9/16"	N/A	9"	9/16"	RSP
IP620	27	6/8	PLANTATION PINE	4-9/16"	4-7/16"	N/A	9-1/8"	N/A	RSP
IP620	27	8/0	PLANTATION PINE	4-9/16"	4-7/16"	N/A	9-1/8"	N/A	RSP
IP620F	27	6/8	PLANTATION PINE	4-9/16"	4-7/16"	N/A	9-1/8"	N/A	RSP
IP625	27	6/8	PLANTATION PINE	4-9/16"	4-7/16"	N/A	9-1/8"	N/A	RSP
IP625F	27	6/8	PLANTATION PINE	4-9/16"	4-7/16"	N/A	9-1/8"	N/A	RSP
IP626	27	8/0	PLANTATION PINE	4-9/16"	4-7/16"	N/A	9-1/8"	N/A	RSP
IP627	27	6/8	PLANTATION PINE	4-9/16"	4-7/16"	N/A	9-1/8"	N/A	RSP
IP627F	27	6/8	PLANTATION PINE	4-9/16"	4-7/16"	N/A	9-1/8"	N/A	RSP
IP628	27	8/0	PLANTATION PINE	4-9/16"	4-7/16"	N/A	9-1/8"	N/A	RSP
IP720	25	6/8	PLANTATION PINE	4-3/8"	4-5/16"	N/A	9-3/16"	3/8"	RSP
IP720	25	8/0	PLANTATION PINE	4-3/8"	4-5/16"	N/A	9-3/16"	3/8"	RSP
IP730	25	6/8	PLANTATION PINE	4-3/8"	4-5/16"	N/A	9-3/16"	3/8"	RSP
IP730	25	8/0	PLANTATION PINE	4-3/8"	4-5/16"	N/A	9-3/16"	3/8"	RSP
IP760	25	6/8	PLANTATION PINE	4-3/8"	4-5/16"	N/A	9-3/16"	3/8"	RSP
IP760	25	8/0	PLANTATION PINE	4-3/8"	4-5/16"	N/A	9-3/16"	3/8"	RSP
IP755	25	6/8	PLANTATION PINE	4-3/8"	4-5/16"	N/A	9-3/16"	3/8"	RSP

# Stile & Rail Dimensions

DOOR STYLE	PAGE	DOOR HEIGHT	SPECIES	3'0" STILE	TOP RAIL	LOCK RAIL	BOTTOM RAIL	PANEL	VENDOR
IP756	25	8/0	PLANTATION PINE	4-3/8"	4-5/16"	N/A	9-3/16"	3/8"	RSP
IP782	25	6/8	PLANTATION PINE	4-3/8"	4-5/16"	7-1/2"	9-3/16"	3/8"	RSP
IP782	25	8/0	PLANTATION PINE	4-3/8"	4-5/16"	7-1/2"	9-3/16"	3/8"	RSP
KAB2ASRR *	49	6/8	KNOTTY ALDER	4-11/32"	8-1/32"	7-1/2"	9"	1-3/16"	WOODGRAIN
KAB2ASRR *	49	8/0	KNOTTY ALDER	4-11/32"	8-1/32"	7-1/2"	9"	1-3/16"	WOODGRAIN
KAB2ASRR	49	6/8	KNOTTY ALDER	4-11/32"	8-1/32"	7-1/2"	9"	1-3/16"	WOODGRAIN
KAB2ASRP *	49	6/8	KNOTTY ALDER	4-11/32"	8-1/32"	7-1/2"	9"	1-3/16"	WOODGRAIN
KP22	31	6/8	KNOTTY PINE	4-9/16"	4-1/2"	7-1/2"	9-1/8"	11/16"	RSP
KP22	31	8/0	KNOTTY PINE	4-9/16"	4-1/2"	7-1/2"	9-1/8"	11/16"	RSP
KP22V *	31	6/8	KNOTTY PINE	4-9/16"	6-5/16"	7-1/2"	9-1/8"	11/16"	RSP
KP22V *	31	8/0	KNOTTY PINE	4-9/16"	6-5/16"	7-1/2"	9-1/8"	11/16"	RSP
KP66	31	6/8	KNOTTY PINE	4-9/16"	4-1/2"	7-1/2"	9-1/8"	11/16"	RSP
MP1022	47	6/8	MAPLE	4-1/2"	4-3/8"	4-1/2"	9-3/16"	3/8"	SIMPSON
MP1033	47	6/8	MAPLE	4-1/2"	4-3/8"	4-1/2"	9-3/16"	3/8"	SIMPSON
O44	51	6/8	OAK	4-5/8"	4-7/16"	7-1/2"	9-3/16"	3/4"	SIMPSON
O66	51	6/8	OAK	4-5/8"	4-7/16"	7-1/2"	9-1/8"	3/4"	SIMPSON
O66 BIFOLD	51	6/8	OAK	1-19/16"	4-7/16"	7-1/2"	7-7/8"	3/4"	SIMPSON
O1310	53	6/8	OAK	4-5/8"	4-7/16"	N/A	9-3/16"	N/A	SIMPSON
O1315	53	6/8	OAK	4-5/8"	4-7/16"	N/A	9-3/16"	N/A	SIMPSON
P44	13	6/0	PONDEROSA PINE	4-17/32'	4-9/16"	7-1/2"	9"	9/16"	WOODGRAIN
P44	13	6/6	PONDEROSA PINE	4-17/32'	4-9/16"	7-1/2"	9"	9/16"	WOODGRAIN
P44	13	6/8	PONDEROSA PINE	4-17/32'	4-9/16"	7-1/2"	9"	9/16"	WOODGRAIN
P44	13	7/0	PONDEROSA PINE	4-17/32'	4-9/16"	7-1/2"	9"	9/16"	WOODGRAIN
P44 BIFOLD	13	6/8	PONDEROSA PINE	2-1/8"	4-9/16"	7-1/2"	8-1/4"	9/16"	WOODGRAIN
P45 *	13	6/8	PONDEROSA PINE	4-17/32'	6-1/16"	7-1/2"	9"	9/16"	WOODGRAIN
P64	11	6/8	PONDEROSA PINE	4-17/32'	4-9/16"	7-1/2"	9"	1-3/16"	WOODGRAIN
P67	13	6/8	PONDEROSA PINE	4-17/32'	4-9/16"	7-1/2"	9"	9/16"	WOODGRAIN
P82A *	11	6/8	PONDEROSA PINE	4-17/32'	8-3/64"	7-1/2"	9"	1-3/16"	WOODGRAIN
P82	11	6/8	PONDEROSA PINE	4-17/32'	4-9/16"	7-1/2"	9"	1-3/16"	WOODGRAIN
P85	13	6/8	PONDEROSA PINE	4-17/32'	4-9/16"	N/A	9"	9/16"	WOODGRAIN
P108	13	6/0	PONDEROSA PINE	4-17/32'	4-9/16"	7-1/2"	9"	9/16"	WOODGRAIN
P108	13	6/6	PONDEROSA PINE	4-17/32'	4-9/16"	7-1/2"	9"	9/16"	WOODGRAIN
P108	13	6/8	PONDEROSA PINE	4-17/32'	4-9/16"	7-1/2"	9"	9/16"	WOODGRAIN
P108	13	7/0	PONDEROSA PINE	4-17/32'	4-9/16"	7-1/2"	9"	9/16"	WOODGRAIN
P108 BIFOLD	13	6/8	PONDEROSA PINE	2-1/8"	4-9/16"	7-1/2"	8-1/4"	9/16"	WOODGRAIN
P730	29	6/8	PONDEROSA PINE	4-1/4"	4-1/16"	5-3/16"	7"	N/A	WOODGRAIN
P730 BIFOLD	29	6/8	PONDEROSA PINE	2-5/32"	4-1/16"	5-3/16"	6"	N/A	WOODGRAIN
P732	29	6/8	PONDEROSA PINE	4-1/4"	4-1/16"	5-3/16"	7"	9/16"	WOODGRAIN
P732 BIFOLD	29	6/8	PONDEROSA PINE	2-5/32"	4-1/16"	5-3/16"	6"	9/16"	WOODGRAIN
P1051	14	6/6	PONDEROSA PINE	4-17/32'	4-9/16"	9"	7-1/2"	9/16"	WOODGRAIN
P1051	14	6/8	PONDEROSA PINE	4-17/32'	4-9/16"	9"	7-1/2"	9/16"	WOODGRAIN
P1051 BIFOLD	14	6/8	PONDEROSA PINE	2-3/16"	4-9/16"	9"	6-1/2"	9/16"	WOODGRAIN
P1053	14	6/6	PONDEROSA PINE	4-17/32'	4-9/16"	9"	7-1/2"	9/16"	WOODGRAIN
P1053	14	6/8	PONDEROSA PINE	4-17/32'	4-9/16"	9"	7-1/2"	9/16"	WOODGRAIN



DOOR STYLE	PAGE	DOOR HEIGHT	SPECIES	3'0" STILE	TOP RAIL	LOCK RAIL	BOTTOM RAIL	PANEL	VENDOR
<b>P1053 BIFOLD</b>	14	6/8	PONDEROSA PINE	2-3/16"	4-9/16"	9"	6-1/2"	9/16"	WOODGRAIN
<b>P1088</b>	13	6/8	PONDEROSA PINE	4-17/32'	4-9/16"	N/A	9"	9/16"	WOODGRAIN
<b>P1501</b>	18	6/8	PONDEROSA PINE	4-17/32'	4-9/16"	N/A	9"	N/A	WOODGRAIN
<b>P1501</b>	18	7/0	PONDEROSA PINE	4-17/32'	4-9/16"	N/A	9"	N/A	WOODGRAIN
<b>P1505</b>	17	6/8	PONDEROSA PINE	4-17/32'	4-9/16"	N/A	9"	N/A	WOODGRAIN
<b>P1509</b>	17	6/8	PONDEROSA PINE	4-17/32'	4-9/16"	N/A	9"	N/A	WOODGRAIN
<b>P1510</b>	17	6/8	PONDEROSA PINE	4-17/32'	4-9/16"	N/A	9"	N/A	WOODGRAIN
<b>P1510</b>	17	7/0	PONDEROSA PINE	4-17/32'	4-9/16"	N/A	9"	N/A	WOODGRAIN
<b>P1510FC</b>	18	6/8	PONDEROSA PINE	4-5/8"	4-7/16"	N/A	9-3/16"	N/A	SIMPSON
<b>P1512</b>	17	8/0	PONDEROSA PINE	4-17/32'	4-9/16"	N/A	9"	N/A	WOODGRAIN
<b>P1515</b>	17	6/8	PONDEROSA PINE	4-17/32'	4-9/16"	N/A	9"	N/A	WOODGRAIN
<b>P1515</b>	17	7/0	PONDEROSA PINE	4-17/32'	4-9/16"	N/A	9"	N/A	WOODGRAIN
<b>P1515B</b>	17	6/8	PONDEROSA PINE	4-17/32'	4-9/16"	N/A	9"	N/A	WOODGRAIN
<b>P1515FC</b>	18	6/8	PONDEROSA PINE	4-5/8"	4-7/16"	N/A	9-3/16"	N/A	SIMPSON
<b>P1518</b>	17	8/0	PONDEROSA PINE	4-17/32'	4-9/16"	N/A	9"	N/A	WOODGRAIN
<b>P1705 BIFOLD</b>	17	6/8	PONDEROSA PINE	2-1/8"	4-9/16"	N/A	8"	N/A	WOODGRAIN
<b>P3915V</b>	19	6/8	PONDEROSA PINE	4-17/32'	4-9/16"	N/A	9"	N/A	WOODGRAIN
<b>P4127</b>	15	6/8	PONDEROSA PINE	5-17/32"	4-9/16"	N/A	9"	1/4"	WOODGRAIN
<b>PN108 BIFOLD</b>	29	6/8	PINE	1-1/4"	3-3/16"	3-5/16"	3"	1/4"	RSP
<b>PN730 BIFOLD</b>	29	6/8	PINE	1-1/4"	3-3/16"	3-5/16"	3"	N/A	RSP
<b>PN732 BIFOLD</b>	29	6/8	PINE	1-1/4"	3-3/16"	3-5/16"	3"	1/4"	RSP
<b>T001 TRANSOM</b>	19	1/0	PONDEROSA PINE	4-1/2"	2-3/8"	N/A	2-3/8"	N/A	WOODGRAIN
<b>T003 TRANSOM</b>	19	1/0	PONDEROSA PINE	4-1/2"	2-3/8"	N/A	2-3/8"	N/A	WOODGRAIN
<b>T004 TRANSOM</b>	19	1/0	PONDEROSA PINE	4-1/2"	2-3/8"	N/A	2-3/8"	N/A	WOODGRAIN
<b>T005 TRANSOM</b>	19	1/0	PONDEROSA PINE	4-1/2"	2-3/8"	N/A	2-3/8"	N/A	WOODGRAIN

# Finishing

## HANDLING

1. Protect door from abuse and mishandling. Take special care with glass.
2. Avoid dragging doors across one another and keep doors clean.
3. Store flat on a level surface in a dry, well ventilated building.
4. Doors should be conditioned to average prevailing relative humidity of the locality before hanging.
5. Doors should not be subjected to extreme or rapid changes in heat or humidity. Avoid sudden changes such as forced heat to dry out a building.
6. If the doors are to be stored on the job site, all surfaces including ends and edges must be sealed with an effective quality oil-base sealer in order to prevent undue moisture absorption. Primers are not sealants.

## GENERAL NOTES ON FINISHING

1. Before applying the first coat of finish, sand the entire surface lightly with 5/0 sandpaper (180 grit). This is to remove fingerprints and handling marks.
2. Adjust or align components if necessary before finishing. Wood panels “float” and may be knocked into alignment with a wood block and hammer. Be careful not to damage door.
3. After sanding, clean the door thoroughly with a cloth to remove all dust or foreign material. However, avoid using caustic or abrasive cleaners.
4. All surfaces of the door must be properly finished. The edges (top, bottom and sides) should be coated with each and every coat of finish that is applied to the exterior surface of the door. Doors must be dry before finishing. There can be significant humidity variance in homes from winter to summer and interior millwork will move. Finishing all sides properly protects your doors.
5. Note: It is the finisher’s responsibility to protect glass prior to and during finishing. If using tape, conduct a test of the tape being used on a small area of the glass before applying to a large surface. After finishing, remove the tape as soon as possible. If the glass has plastic film protection, removal of the plastic film protection immediately after applying the finish is required. Failure to remove the plastic film at this time may cause harm to the glass and will create difficulty in removing the film at a later time. Do not use razor blades or sharp objects to remove the film or clean the glass. These items will scratch the glass.

## INTERIOR FINISHING - STAIN

All stained products should use a stain controller prior to staining. Some species stain better than others. Please see individual species for stainmeter.

A good preparation is critical for good results. Sand the door and keep it very clean. Use a tack cloth to remove all particulate matter. Apply stain conditioner following manufacturers’ instructions. Stain product and let dry. Finish with 2 or more coats of finish. InteriorClear finishes can be varnish, tung/teak oils, lacquers, etc.

**Varnishes** - Oil and water based. Oil finishes dry slower and give the finish coat a slight glow in color. Water based varnishes are fast drying and have little or no color and depth.

**Oils** like tung and teak oils are wipe on finishes. These dry slow and require many coats (4 or more). They typically give an amber color to the finish.

**Lacquers** are fast drying finishes that are durable and give a nice depth and soft color.

## A NOTE ABOUT PINE.

Pine varies sometimes dramatically in density.

The best stained pine finishes come from Ponderosa Pine. This species has the best consistency in density and finishes nicely. This product is the “best” Pine door species. All exterior Pine doors are Domestic Ponderosa Pine.

The “White” pine product is beautiful in unfinished color consistency but has a characteristic of very pronounced color variation when stained. This product is great for Clear coats and paints. This is Reeb’s “better” Pine door.

Plantation Pine has very pronounced grain patterns. The trees it is made from are very fast growing and the growth rings are very large. It can stain inconsistently. This is a “good” pine door that is made very well and good for value stain/paint needs.

## INTERIOR FINISHING - PAINT

Follow all manufacturer finishing instructions for the best result. Unprimed doors should be primed with a good quality primer followed by two or more top coats of good quality solvent-base or latex enamel paint. It is recommended that sanding be done between coats of primer and paint.

## MAINTENANCE

Best results will include light sanding and thorough cleaning between coats of paint. Do not skip light sanding after applying the coat of primer. Take care not to sand any glass. Let paint dry between coats. Always use top quality brushes, rollers and paint.

## CHALKBOARD PANEL DOOR

Breaking in a new chalkboard door:

1. Wash the chalkboard surface daily with cool water for one week.
2. Wash only a small section at a time, immediately rubbing dry with a lint-free cloth.
3. Repeat until the entire surface of the chalkboard has been washed.
4. After washing, hold a stick of chalk flat on the board and cover the entire surface.
5. Erase evenly. The chalkboard is now ready to use.

## MAINTENANCE TIPS:

1. Clean erasers frequently.
2. Use white chalk rather than yellow or colored chalk, as the pigments can make them more difficult to erase.
3. Wash the chalkboard weekly if necessary.
4. Look for high grade chalk (95% chalk with a 5% binder), as inferior chalk may permanently mark the chalkboard.

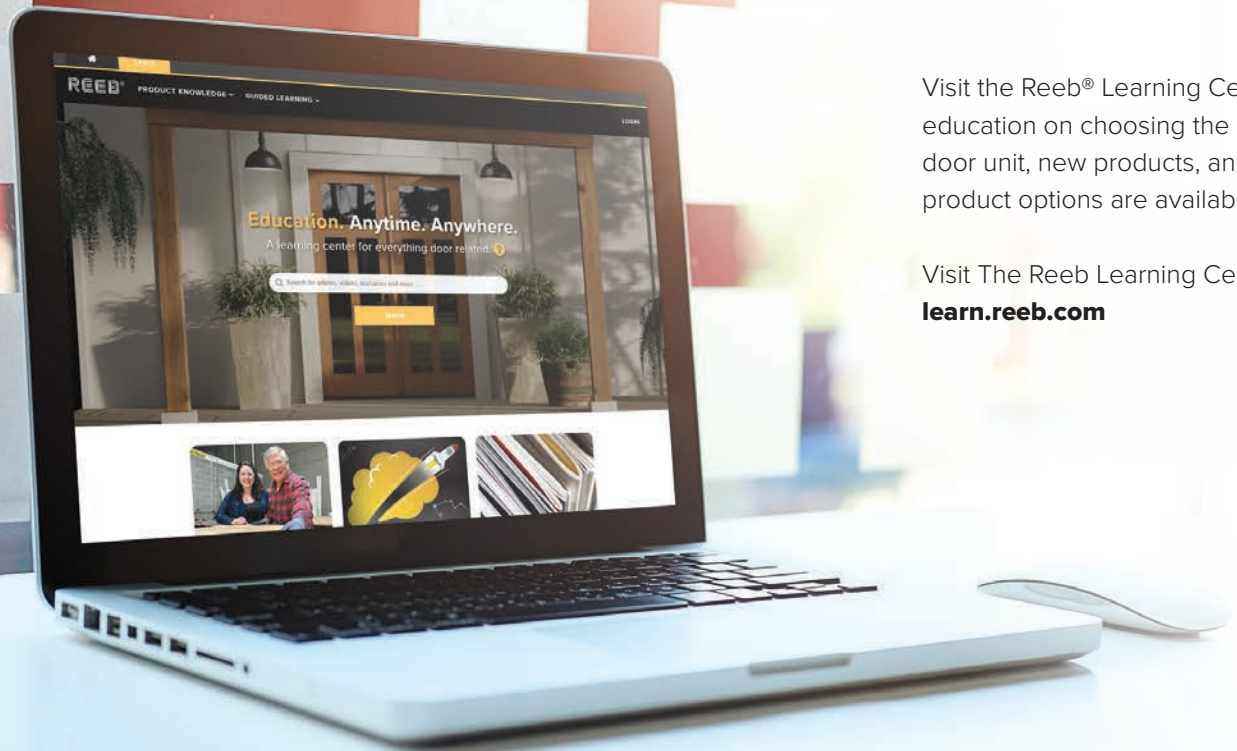

Visit the Reeb® Learning Center for education on choosing the proper door unit, new products, and what product options are available.

Visit The Reeb Learning Center at **[learn.reeb.com](http://learn.reeb.com)**



A learning center for everything door related.



### Online Interior Stile & Rail Catalog

View product warranties, care and finishing instructions for the following companies at **[reeb.com/catalogs/](http://reeb.com/catalogs/)**



### Warranty Information

View product warranties at **[reeb.com/warranties/](http://reeb.com/warranties/)**

□ **Bethlehem, PA**  
1000 Maloney Cir.  
Bethlehem, PA 18015  
(800) 862-8622 voice  
(800) 772-7332 fax

□ **Barclay, MD**  
1315 Goldsboro Rd.  
Barclay, MD 21607  
(800) 825-8331 voice  
(800) 331-9387 fax

□ **Mocksville, NC**  
346 Bethel Church Rd.  
Mocksville, NC 27028  
(800) 642-0886 voice  
(800) 618-0620 fax

□ **Providence, RI**  
19 Business Park Dr.  
Smithfield, RI 02917  
(800) 343-5703 voice  
(800) 388-5979 fax

□ **Syracuse, NY**  
7475 Henry Clay Blvd.  
Liverpool, NY 13088  
(800) 422-5224 voice  
(800) 531-7332 fax



**PART# REEBINT22**

VERSION 1.0.0