



# EMPIRE

Moulding & Millwork

A NOVO Building Products Company

**MOULDINGS | STAIR PARTS | BOARDS | EXTERIOR MILLWORK**  
**NORTHEAST DISTRIBUTION CENTER**



## TABLE OF CONTENTS

INSPIRATION .....	8-19
BUILD-UPS .....	20-21
OMI DECORATIVE ACCESSORIES.....	22-26
FLEXIBLE MOULDING .....	27
BOARDS .....	28
DOOR JAMBS .....	29
CASING.....	30-32
OMI CRAFTSMAN ARCHITRAVES .....	33
ROSETTES & PLINTH BLOCKS.....	34
CORBELS & CORNER BLOCKS .....	35
BASE CAPS.....	36
BASE.....	36-39
CROWN.....	40-43
CROWN BLOCKS .....	44
RAILS .....	44
STOOLS & SILLS.....	45
WINDOW & DOOR MISC .....	45
STOPS .....	46
MULLIONS .....	46
PANEL, CAP, BACK BAND.....	47
CHAIR RAIL.....	47
MISCELLANEOUS .....	48
WALL PANELS .....	49
TURNCRAFT COLUMNS.....	50-51
PARTS INDEX .....	52

Style is individual, personal, and unique.  
Make your room a reflection of you...

# DISTINGUISH YOUR STYLE



# Traditional





Achieve a similar look using: Chair Rail | **041** Crown | **5010** Architrave | **445A** Casing plus **281** Back Band | **738** Base

## Traditional

Traditional Mouldings enhance any home style from Midwestern, Early American to Coastal. They blend perfectly with the classic style furnishing and timeless building materials of today. Empire has a vast selection of traditional style mouldings to match and enhance your own unique style.

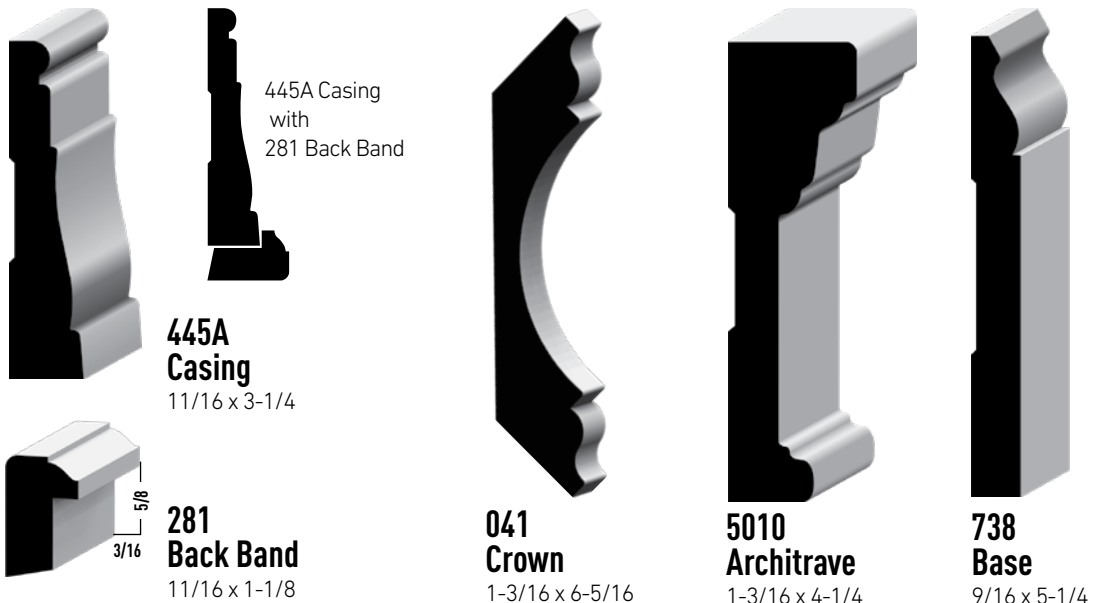

Profiles shown are not to scale.

**WARNING:** Drilling, sawing, sanding or machining wood products can expose you to wood dust, a substance known to the State of California to cause cancer. Avoid inhaling wood dust or use a dust mask or other safeguards for personal protection. For more information go to [www.P65Warnings.ca.gov/wood](http://www.P65Warnings.ca.gov/wood)



# Contemporary

**ECLECTIC, ARTISTIC, AVANT-GARDE  
FULL OF LIFE, CULTURE, COLOR, TEXTURE  
UNIQUE & FOUND OBJECTS  
NATURAL & MAN MADE MATERIALS**



The mouldings listed may not be as shown in the image but are represented to achieve a similar style or look: **505 Crown** | **682 Casing** | **512 Base** | **876 Stop** used as Shoe

## Contemporary

At its core, the word "contemporary" means "of the moment." Sleek & thoughtful, contemporary design spaces often feature a mixture of both straight and elegantly curved lines, which can be seen as a slight nod to this style's art deco roots. Today, the look is defined by curved lines, and embraces minimalistic elements highlighting grays, beiges and shades of white. Although the contemporary trend changes with time, the basic cutting edge simplicity and idealism remains as unique as your vision.



**505 Crown**  
1 x 7



**682 Casing**  
1 x 3-1/4



**512 E1E Base**  
1/2 x 5-1/2

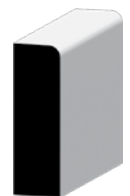

**876 E1E Stop**  
7/16 x 1-3/8

Profiles shown are not to scale.

**WARNING:** Drilling, sawing, sanding or machining wood products can expose you to wood dust, a substance known to the State of California to cause cancer. Avoid inhaling wood dust or use a dust mask or other safeguards for personal protection. For more information go to [www.P65Warnings.ca.gov/wood](http://www.P65Warnings.ca.gov/wood)



# Victorian

GLAMOROUS  
ORNATE  
ART DECO  
BAROQUE  
SOUTHERN PLANTATION  
COLONIAL ESTATE







The mouldings listed may not be as shown in the image but are represented to achieve a similar style or look: **53 Crown** | Panels: **1217 Panel Mould** & **8416 Cap** | **7055 Base** | **126 Shoe**  
 Coffered Ceiling Buildups: **1x4** & **1x6** Boards | **623 Base** | **936 Stop**

## Victorian

Victorian Mouldings hearken to the richness of old world artisan builders, craftsman and clothiers that regarded every part of their work a piece of art. It is a style that can transform the bland into a bold statement of line and form. Ornate mouldings can be combined to restore a great Painted Lady or add a subtle flair and richness to add glamour to any room in your home.

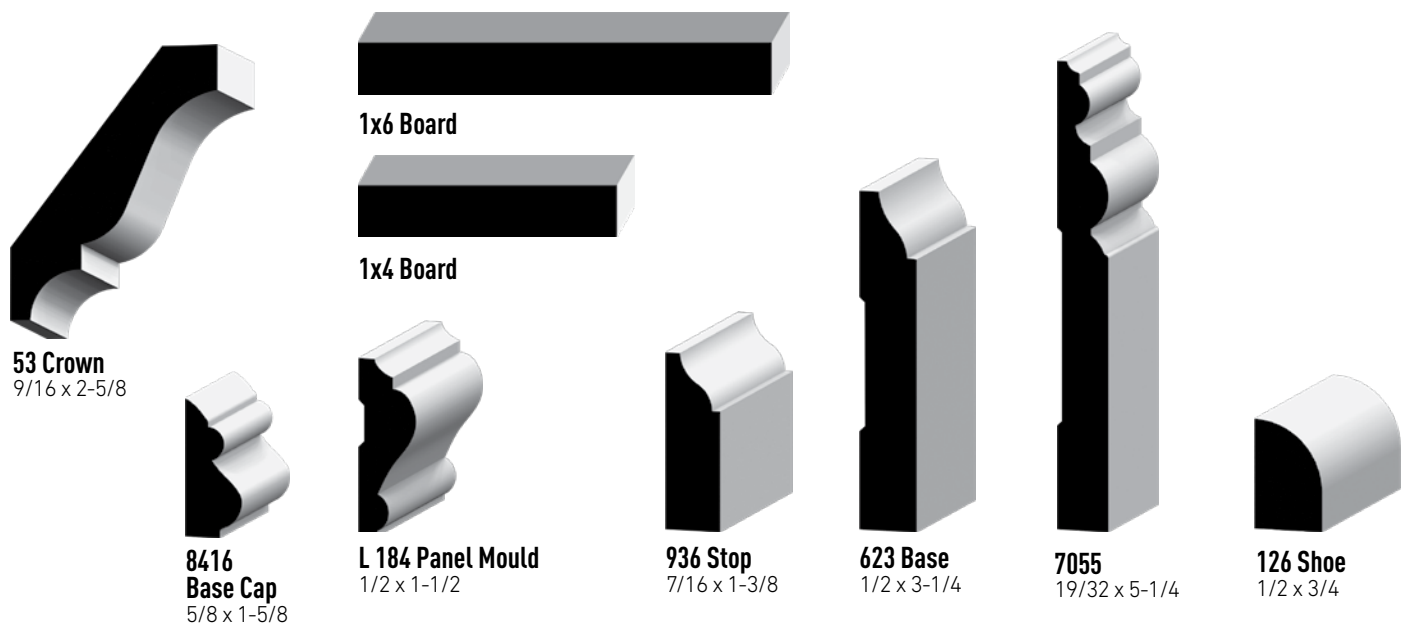

Profiles shown are not to scale.

**⚠️WARNING:** Drilling, sawing, sanding or machining wood products can expose you to wood dust, a substance known to the State of California to cause cancer. Avoid inhaling wood dust or use a dust mask or other safeguards for personal protection. For more information go to [www.P65Warnings.ca.gov/wood](http://www.P65Warnings.ca.gov/wood)

FARM & COTTAGE  
RUSTIC & FINISHED  
HANDCRAFTED & MILLED  
NATURAL & PAINTED WOODS  
STURDY BEAMS & HEADERS  
LIVABLE LUXURY — FRONTIER SIMPLICITY...  
WORK RESTORE



# Farmhouse



The mouldings listed may not be as shown in the image but are represented to achieve a similar style or look: **B G312 Casing w/B G200 Back Band Casing | B G312 Base | B G100 Shoe | SL16 Shiplap BEAMRUSTIC-8WM5x3 Faux Beam**

## Farmhouse

Classic, elegant and comfortable, the modern farmhouse decorating is rooted in rustic country charm peppered with warm minimalism. Striking just the right balance of pastoral and refined, modern farmhouse decor emphasizes comfort and casual living with contemporary sensibilities reflective of today's times. Empire stocks a wide variety of hardwood and primed mouldings, boards, and wall panels from wainscoting, bead-board to shiplap. Combined with faux beams from Ornamental Mouldings to create warm and inviting spaces from cozy to dramatic and inviting for a family gathering



**SL16  
Nickel Gap  
Shiplap**  
5/8 x 5-1/2



**B G200 Bevel Nose  
Back Band**  
1-1/16 x 1-1/16



**B G312 Casing**  
1 1/16 x 3-1/2



**B G512 Base**  
9/16 x 5-1/2



**BEAMRUS-  
TIC-8WM5x5**  
Rustic Maple Beam



**B G100 Shoe**  
5/8 x 1

Profiles shown are not to scale.

**⚠️WARNING:** Drilling, sawing, sanding or machining wood products can expose you to wood dust, a substance known to the State of California to cause cancer. Avoid inhaling wood dust or use a dust mask or other safeguards for personal protection. For more information go to [www.P65Warnings.ca.gov/wood](http://www.P65Warnings.ca.gov/wood)



LINE & STRUCTURE  
HANDCRAFTED  
ARCHITECTURAL  
ARTISAN CRAFTSMAN  
MODERN-FARMHOUSE  
WESTERN RANCH

# Craftsman



The mouldings listed may not be as **5010 Architrave** | **412 Casing** | **L 432 Casing w/280 Back Band** | **L 414 E1E Base w/280 Back Band** | **L 254 Shoe** shown in the image but are represented **BEAMRUSTIC-8WM5x5 Faux Beam** to achieve a similar style or look:

## Craftsman

Craftsman homes are full of endless detail and character, known for their natural materials, cozy interiors, and wide porches. Patterns and lines show the Arts & Crafts Architectural style through the use of natural woods combined with simple paint schemes. Wainscoting or beadboard detailing, and decorated ceilings with beams will help to give your home that warm feeling.



**5010 Architrave**  
1-3/16 x 4-1/4



**412 E2E Casing**  
19/32 x 3-1/2



**L 432 E1E Casing**  
9/16 x 3-1/2

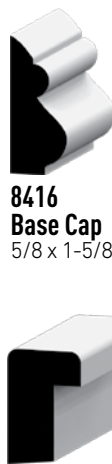

**280 Back Band**  
11/16 x 1-1/8



**L 414 E1E Base**  
9/16 x 4-1/4

**8416 Base Cap**  
5/8 x 1-5/8



**BEAMRUSTIC-8WM5x5**  
Rustic Maple Beam

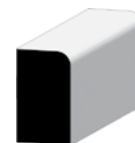

**L 254 Craftsman Shoe**  
7/16 x 3/4

Profiles shown are not to scale.

**WARNING:** Drilling, sawing, sanding or machining wood products can expose you to wood dust, a substance known to the State of California to cause cancer. Avoid inhaling wood dust or use a dust mask or other safeguards for personal protection. For more information go to [www.P65Warnings.ca.gov/wood](http://www.P65Warnings.ca.gov/wood)

# Craftsman | Sleek, Modern, Simple

## Crown



**E519**  
9/16 x 4-1/4  
MDF 16'



**CR291**  
3/4 x 5-1/4  
MDF 16'

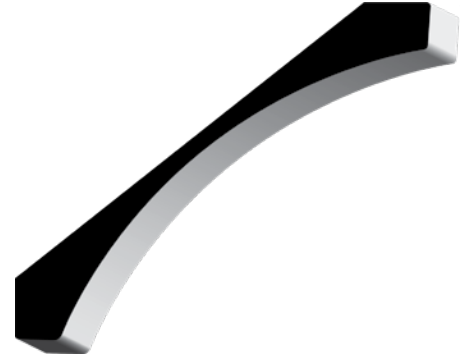

**505**  
1 x 7  
MDF 16'

## Base Cap | Base



**B GC1**  
**Slant Cap**  
3/4 x 1-1/16  
PRIMED 16'



**B GC2**  
**Chamfer Cap**  
3/4 x 1-1/16  
PRIMED 16'



**L 433E E1E**  
1/2 x 3-1/4  
MDF 8' | 12' | 16'



**L 414 E1E**  
9/16 x 4-1/4  
PRIMED 16'



**W B514**  
9/16 x 5-1/4  
PRIMED 16'



**L 514 E1E**  
9/16 x 5-1/4  
PRIMED 16'



**512E E1E**  
1/2 x 5-1/2  
MDF 16'



**B G512**  
9/16 x 5-1/2  
PRIMED 16'



**B G712**  
9/16 x 7-1/2  
PRIMED 16'

## Shoe

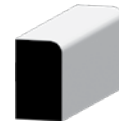

**L 254 Shoe**  
7/16 x 3/4  
PRIMED  
8' | 12' | 16'



**B G100 Shoe**  
5/8 x 1  
PRIMED  
16'

## Back Band

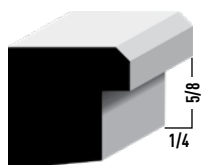

**B G200 Bevel Nose Back Band**  
1-1/16 x 1-1/16  
PRIMED 16'

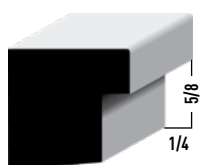

**B G250 Eased Nose Back Band**  
1-1/16 x 1-1/16  
PRIMED 16'



## Casing



**L 473 E2E**  
19/32 x 2-1/4  
MDF 7'6" | 15'

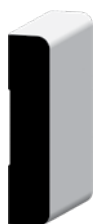

**472 E2E**  
9/16 x 2-1/2  
PRIMED 16'  
19/32 x 2-1/2  
MDF 16'



**L 452 E1E**  
11/16 x 2-1/2  
PRIMED 16'



**452 E2E**  
11/16 x 2-1/2  
PRIMED 16'



**B G212**  
11/16 x 2-1/2  
PRIMED 16'



**B G312**  
11/16 x 3-1/2  
PRIMED 16'



**L 412 E1E**  
11/16 x 3-1/2  
PRIMED 16'



**412 E2E**  
19/32 x 3-1/2  
MDF 16'



**432 E2E**  
9/16 x 3-1/2  
PRIMED 16'



**L 432 E1E**  
9/16 x 3-1/2  
PRIMED 16'



**W C312**  
11/16 x 3-1/2  
PRIMED 16'



**STCA**  
13/16 x 3-1/2  
PRIMED 16'



**SCCA**  
13/16 x 3-1/2  
PRIMED 16'

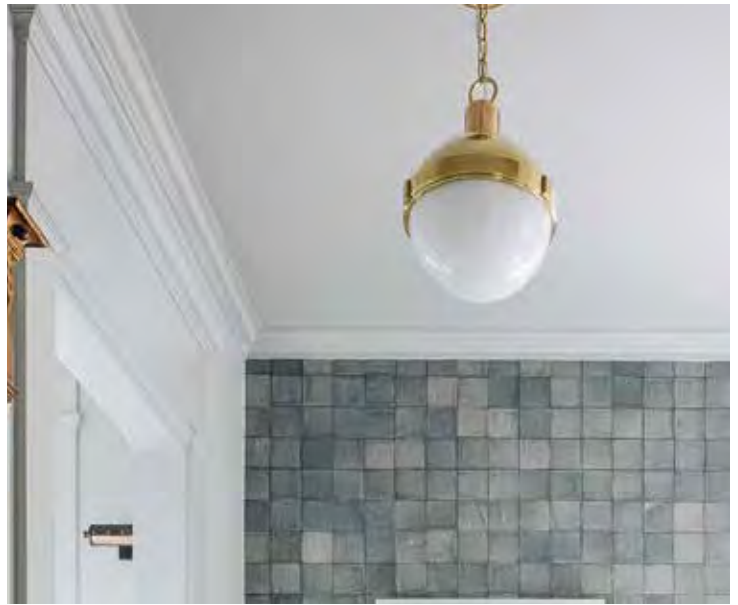

## Combine moulding patterns to create a unique home style.

- Combine crowns, bases, casing, panel moulds, shoe or quarter rounds and more, to create detail, line and pattern.
- Use boards or square stock to build up depth.
- Combine square and eased edges to create richer detail.
- Use moulding with the same style families for a harmonious feel.
- Create completely unique build-ups to fit your own style.



Build-Ups can dramatically change any space adding rich detail for low-cost.

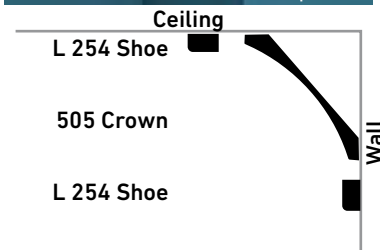
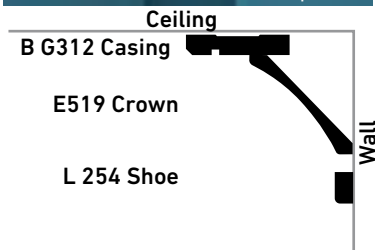



**Build-Up combinations are as limitless as your imagination.  
Create a look that is uniquely you.**

## Build-Ups | Fireplace Surround

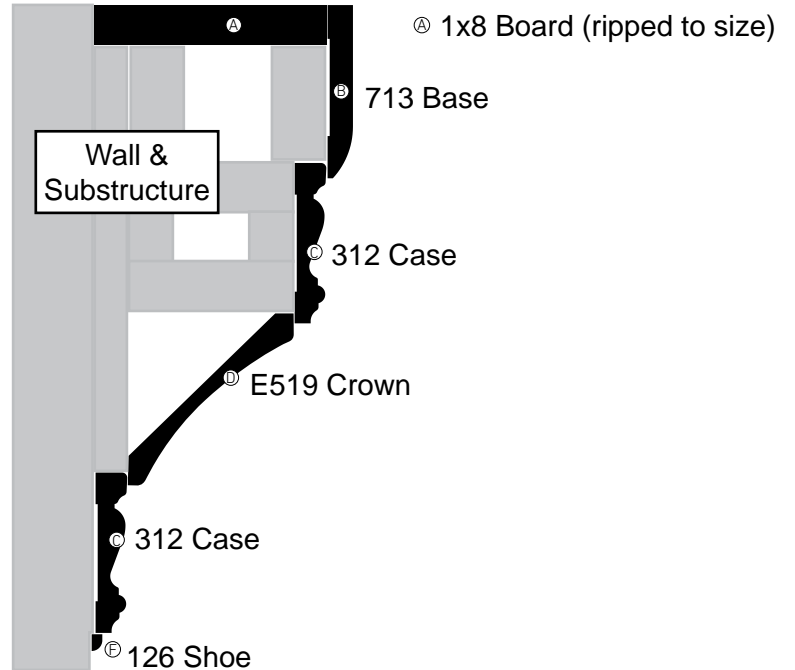

## Build-Ups | Casing



- Ⓐ L 887 Mullion
- Ⓑ 444 Casing
- Ⓒ 93 Cove

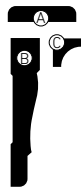

- Ⓐ L 49 Crown
- Ⓑ 1X4 S4S
- Ⓒ 93 Cove

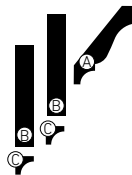

## Build-Ups | Crown

- 041 Crown Ⓐ
- L 414 E1E Base Ⓑ
- 8416 Base Cap Ⓒ



## Build-Ups | Base



- 7163 Base Ⓐ
- 738 Base Ⓑ
- 947 Stop Ⓒ



- Ⓐ 126 Shoe
- Ⓑ 1X6 S4S
- Ⓒ 663 Base
- Ⓓ 106 Quarter Round



## Build-Ups | Chair



- Ⓐ W 956 Chair Rail Backer
- Ⓑ 300 Chair Rail

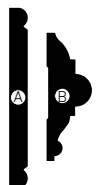

# Decorative Accessories

## ORNAMENTAL

— DECORATIVE MILLWORK —

A NOVO Building Products Company

Expressing a style comes easier and has greater impact when your choices—from ceiling to floor—are all unified. For nearly 100 years, Ornamental Mouldings has been providing distinctive, high-quality millwork to make entire living spaces more beautiful. Our decorative accessory styles inspired by tradition and shaped by the latest trends complement one another for unmatched selection, all in one place.

### Mantels and Floating Shelves

Whenever people enter a room, their eyes instantly take stock of the space. Reward their gaze with our Mantels and Floating Shelves, which marry function with details that convey a discerning sensibility.



Pattern	Product	H	D	L	Species
3 Ft. Mantel	<b>RUSTIC3WM</b>	5	7	36	Rustic maple
4 Ft. Mantel	<b>RUSTIC4WM</b>	5	7	48	
5 Ft. Mantel	<b>RUSTIC5WM</b>	5	7	60	
6 Ft. Mantel	<b>RUSTIC6WM</b>	5	7	72	



3 Ft. Mantel with insert	<b>RUSTIC3WM-01BK</b>	5	7	36	Rustic maple with aspen insert
4 Ft. Mantel with insert	<b>RUSTIC4WM-01BK</b>	5	7	48	
5 Ft. Mantel with insert	<b>RUSTIC5WM-01BK</b>	5	7	60	
6 Ft. Mantel with insert	<b>RUSTIC6WM-01BK</b>	5	7	72	



4 Ft. Mantel	<b>CLASSIC4WHW</b>	3 3/4	7 3/4	48	WHW
5 Ft. Mantel	<b>CLASSIC5WHW</b>	3 3/4	7 3/4	60	WHW
6 Ft. Mantel	<b>CLASSIC6WHW</b>	3 3/4	7 3/4	72	WHW



5 Ft. Mantel	<b>CLASSIC5OAK</b>	3 3/4	7 3/4	60	Oak
6 Ft. Mantel	<b>CLASSIC6OAK</b>	3 3/4	7 3/4	72	Oak

All measurements are in inches. These items may be special order. Please call for details.



Farmhouse | **OML14B, OML24C** | Mantel and Beams

## Wood Beams

Practical elements like ceiling beams and wooden stairs are prime places for expressing your style. Our Wood Beams and Decorative Stair Parts give you the tools to achieve drama or convey delicate detailing.



Pattern	Product	H	W	L	Species
Prefinished gray beam	<b>BEAMGRAY-8WHW5X3</b>	3	5	96	Gray WHW
Prefinished gray beam	<b>BEAMGRAY-8WHW5x5</b>	5	5	96	Gray WHW
Rustic maple beam	<b>BEAMRUSTIC-8WM5x3</b>	3	5	96	Rustic maple
Rustic maple beam	<b>BEAMRUSTIC-8WM5x5</b>	5	5	96	Rustic maple
3 inch metal beam-band/bracket	<b>BR-0003MTL</b>	3 <sup>9</sup> / <sub>64</sub>	1 1/2	6 <sup>7</sup> / <sub>16</sub>	Metal
5 inch metal beam-band/bracket	<b>BR-0005MTL</b>	5 <sup>17</sup> / <sub>64</sub>	1 1/2	6 <sup>5</sup> / <sub>16</sub>	Metal

All measurements are in inches. These items may be special order. Please call for details.



Rustic | BR-0001WM, BEAMGRAY-8WHW5x5, 1248C, 1536, 917PB, 1537

## Decorative Boards

Create an impact that is more than meets the eye. Use our Decorative Boards to express your creativity with combinations that even at first glance speak volumes about your personal style.



Pattern	Product	W	T	L	Species
Decorative boards	<b>AMAP 1/2X2X96</b>	1 1/2	7/16	96	Ambrosia Maple
	<b>WOAK 1/2x2x96</b>	1 1/2	7/16	96	White Oak
Decorative boards eased edge two sides	<b>1538-8GRAY</b>	1 1/2	7/16	96	Gray Stain
	<b>1538-8BLACK</b>	1 1/2	7/16	96	Black Stain
Decorative boards	<b>AMAP 1/2X4X96</b>	3 1/2	7/16	96	Ambrosia Maple
	<b>WOAK 1/2X4X96</b>	3 1/2	7/16	96	White Oak
Decorative boards eased edge two sides	<b>1536-8GRAY</b>	3 1/2	7/16	96	Gray Stain
	<b>1536-8BLACK</b>	3 1/2	7/16	96	Black Stain
Decorative boards	<b>AMAP 1/2X6X96</b>	5 1/2	7/16	96	Ambrosia Maple
	<b>WOAK 1/2X6X96</b>	5 1/2	7/16	96	White Oak
Decorative boards eased edge two sides	<b>1537-8GRAY</b>	5 1/2	7/16	96	Gray Stain
	<b>1537-8BLACK</b>	5 1/2	7/16	96	Black Stain

All measurements are in inches. These items may be special order. Please call for details.



Modern Farmhouse | PD001MD742PRIM

## Decorative Stair Parts

Pattern	Product	H	W	T	Species
Primed reversible decorative stair riser	<b>PD001MD742PRIM</b>	7 1/2	42	11/32	MDF
	<b>PD001MD748PRIM</b>	7 1/2	48	11/32	MDF



Primed reversible decorative oak stair riser	<b>PD002OAK742PRIM1</b>	7 1/2	42	11/32	Oak/Prime
	<b>PD002OAK748PRIM1</b>	7 1/2	48	11/32	Oak/Prime



All measurements are in inches. These items may be special order. Please call for details.

ORNAMENTAL

— DECORATIVE MILLWORK —

A NOVO Building Products Company

# Custom Moulding

by ORNAMENTAL DECORATIVE MILLWORK



**Quality custom or short run moulding orders with quick turn around!**

## Specs

- 6-16 ft. lengths (random / clear) - Prime available up to 12 ft.
- Profile max = 11-3/4" width
- Minimum run = 3,000 ft. (less than charge can be applied)
- Unique capabilities: rope, dentil, emboss, carving
- Custom tooling charge may apply

## Material

- Solid Pine, Poplar, Oak (Red or White), Knotty Alder (up to 10 ft.), Others available upon request

## Timing

- Quote turnaround = 2-3 days
- Please contact your Sales Representative

**Made in the USA**

**800.253.9000 | EMPIRECO.COM**

Visit [www.ornamental.com](http://www.ornamental.com) to view the full Ornamental Decorative Millwork offering

*Prominent.  
Beautiful.  
Flexible.*



## THE CARTER MILLWORK ADVANTAGE

Carter Millwork products are made of polyurethane material – a strong, long-lasting and cost-effective alternative to wood and polyester. Each piece of our moulding is individually inspected to ensure compliance to our exacting quality standards.

There are many reasons to choose Carter Millwork products:

- An extensive selection of in-stock items available for immediate shipment
- Thousands of unique profiles available
- Unlimited custom capabilities from historic replicas to contemporary designs
- Polyurethane non-shrink product for compatibility to any moulding profile
- Impervious to moisture – interior or exterior use
- Paintable or stainable – cuts like wood
- Fastest custom order turnaround in the industry
- Stock products shipped within 21 days on custom orders
- Competitive prices
- No minimum order size
- Warranty that moulding is free from defects in materials and workmanship for as long as the original purchaser owns the structure

### HALF ROUND

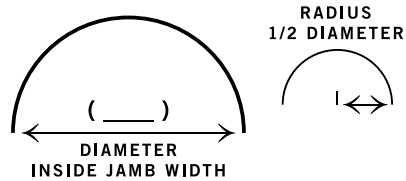

### ARCS

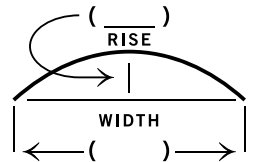

### ELLIPSES

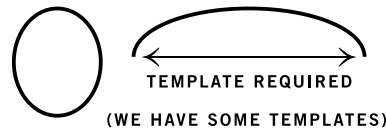

### RADIUS CROWN

CONVEX-OSR  
FOR CROWN & CEILING BACKER

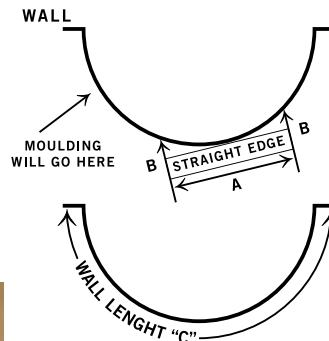

WE NEED "A" LENGTH  
"B" DISTANCE & "C" LENGTH

CONCAVE-ISR  
FOR CROWN & CEILING BACKER

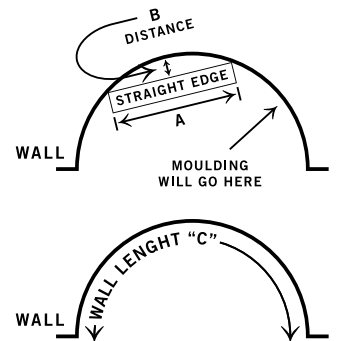

WE NEED "A" LENGTH  
"B" DISTANCE & "C" LENGTH



# Boards



## 250 Board Feet RL Mini-Packs Available Oak | Poplar

### ULTRALITE MDF SHEETS Sold in full units only

<b>344 8 FBDBA</b>	
(18mm) 3/4" thick x 49" wide x 8' long	Around 53 Sheets Per Unit
<b>S124 8 FBDBA</b>	
(12mm) 1/2" thick x 49" wide x 8' long	Around 80 Sheets Per Unit

Limited quantities.

<b>1 X 2</b>	23/32 x 1-1/2	<b>PRIMED</b>	8'   12'
<b>S 1196</b>	11/16 x 2	<b>PRIMED</b>	16'
<b>1 X 3</b>	23/32 x 2-1/2	<b>PRIMED</b>	16'
<b>1/2 X 4</b>	1/2 x 3-1/2	<b>PRIMED</b>	16'
<b>1/2 X 6</b>	1/2 x 5-1/2	<b>PRIMED</b>	16'
<b>1 X 4</b>	3/4 x 3-1/2	<b>PINE</b>	8'   10'   12'   14'   16'
	23/32 x 3-1/2	<b>PRIMED</b>	8'   16'
	11/16 x 3-1/2	<b>MDF</b>	8'   16'   17'
	3/4 x 3-1/2	<b>OAK</b>	8'   10'   12'   16'
	3/4 x 3-1/2	<b>POPLAR</b>	8'   10'   12'   16'
<b>1 X 5</b>	23/32 x 4-1/2	<b>PRIMED</b>	16'
<b>1 X 6</b>	3/4 x 5-1/2	<b>PINE</b>	8'   10'   12'   14'   16'
	23/32 x 5-1/2	<b>PRIMED</b>	8'   16'
	11/16 x 5-1/2	<b>MDF</b>	8'   16'
	3/4 x 5-1/2	<b>OAK</b>	8'   10'   12'   14'   16'
	3/4 x 5-1/2	<b>POPLAR</b>	8'   10'   12'   16'
<b>1 X 8</b>	3/4 x 7-1/4	<b>PINE</b>	8'   10'   12'   14'   16'
	23/32 x 7-1/4	<b>PRIMED</b>	16'
	11/16 x 7-1/4	<b>MDF</b>	8'   16'
	3/4 x 7-1/4	<b>OAK</b>	8'   10'   12'   16'
	3/4 x 7-1/4	<b>POPLAR</b>	8'   10'   12'   16'
<b>1 X 10</b>	3/4 x 9-1/4	<b>PINE</b>	8'   10'   12'   14'   16'
	23/32 x 9-1/4	<b>PRIMED</b>	16'
	11/16 x 9-1/4	<b>MDF</b>	16'
	3/4 x 9-1/4	<b>OAK</b>	8'   10'   12'   14'   16'
	3/4 x 9-1/4	<b>POPLAR</b>	8'   10'   12'   16'
<b>1 X 12</b>	3/4 x 11-1/4	<b>PINE</b>	8'   10'   12'   14'   16'
	23/32 x 11-1/4	<b>PRIMED</b>	16'
	11/16 x 11-1/4	<b>MDF</b>	16'
	3/4 x 11-1/4	<b>OAK</b>	8'   10'   12'   14'
	3/4 x 11-1/4	<b>POPLAR</b>	8'   10'   12'   16'
<b>5/4 X 4</b>	1-1/16 x 3-1/2	<b>PRIMED</b>	16'
		<b>POPLAR</b>	RL only available in Mini-Pack
<b>5/4 X 6</b>	1-1/16 x 5-1/2	<b>PRIMED</b>	16'
		<b>POPLAR</b>	RL only available in Mini-Pack
<b>5/4 X 8</b>	1-1/16 x 7-1/4	<b>PRIMED</b>	16'
		<b>POPLAR</b>	RL only available in Mini-Pack
<b>5/4 X 10</b>	1-1/16 x 9-1/4	<b>PRIMED</b>	16'
		<b>POPLAR</b>	RL only available in Mini-Pack
<b>5/4 X 12</b>	1-1/16 x 11-1/4	<b>PRIMED</b>	16'
		<b>POPLAR</b>	RL only available in Mini-Pack



**PINE**

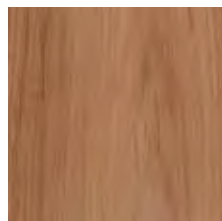

**OAK**



**POPLAR**

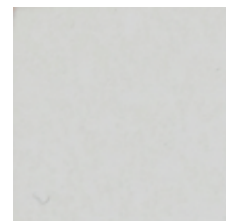

**PRIMED**



# Door Jambs

	JAMB SIZE	DIMENSION	BELOW DADO	PRIMED	PINE VENEER
	478 6'8"	11/16 X 4-7/8 JAMB PAIR	81"	X	
	678 6'8"	11/16 X 6-7/8 FLAT JAMB PAIR	81"	X	
	4916 6'8"	11/16 X 4-9/16 JAMB PAIR	81"	X	X
	X 4916 6'8"	11/16 X 4-9/16 JAMB SIDE	81"		X
	6916 6'8"	11/16 X 6-9/16 JAMB PAIR	81"	X	X
6'9" FLAT JAMBS	L 358 6'9"	11/16 X 3-5/8 FLAT JAMB PAIR W/ LUG	81-1/2"	X	
	L 458 6'9"	11/16 X 4-5/8 JAMB PAIR W/ LUG	81-1/2"	X	
	478 6'9"	11/16 X 4-7/8 FLAT JAMB PAIR	81-1/2"	X	
	L 478 6'9"	11/16 X 4-7/8 JAMB PAIR W/ LUG	81-1/2"	X	
	4916 6'9"	11/16 X 4-9/16 JAMB PAIR	81-1/2"	X	
	6916 6'9"	11/16 X 6-9/16 JAMB PAIR	81-1/2"	X	
	L 6916 6'9"	11/16 X 6-9/16 JAMB PAIR	81-1/2"	X	X
7'0" FLAT JAMBS	378 7'0"	11/16 X 3-7/8 JAMB PAIR	85"	X	
	478 7'0"	11/16 X 4-7/8 FLAT JAMB PAIR	85"	X	
	4916 7'0"	11/16 X 4-9/16 JAMB PAIR	85"	X	
8'0" FLAT JAMBS	378 8'0"	11/16 X 3-7/8 JAMB PAIR	97"	X	
	478 8'0"	11/16 X 4-7/8 FLAT JAMB PAIR	97"	X	
	678 8'0"	11/16 X 6-7/8 FLAT JAMB PAIR 97BD	97"	X	
	4916 8'0"	11/16 X 4-9/16 JAMB PAIR	97"	X	
	6916 8'0"	11/16 X 6-9/16 JAMB PAIR	97"	X	
SPLIT JAMBS	514 6'8"	1-1/16 X 2-3/4 SPLIT JAMB PAIR	81"	X	
	2 4916 6'8"	4-9/16 X 2-3/4 X 2-1/2 SPLIT JAMB PAIR	80-9/16"	X	
LINEAL JAMBS	4916 R7 (17')	11/16 X 4-9/16 JAMB LINEAL	NA	X	
	6916 R7 (17')	11/16 X 6-9/16 JAMB LINEAL	NA	X	

# Casing



**376**  
 19/32 x 2-1/4  
**MDF** 7'1" | 14'  
 11/16 x 2-1/4  
**PRIMED** 7'1" | 10' | 14'  
**PINE** 7' | 10' | 14'



**L 356**  
 1/2 x 2-1/4  
**OAK** 7' | 10'



**356**  
 11/16 x 2-1/4  
**PRIMED** 7'1" | 14'  
**PINE** 7'  
 5/8 x 2-1/4  
**OAK** 7'



**366**  
 11/16 x 2-1/4  
**PRIMED** 7' | 14'  
**PINE** 7'



**327**  
 11/16 x 2-1/4  
**PRIMED** 7' | 14'  
**PINE** 7' | 16'



**366A**  
 19/32 x 2-1/4  
**MDF** 7' | 14'



**B G212**  
 11/16 x 2-1/2  
**PRIMED** 16'



**331**  
 11/16 x 2-1/2  
**PINE** 7' | RL



**361**  
 19/32 x 2-1/2  
**MDF** 14'  
 11/16 x 2-1/2  
**PRIMED** 7' | 14'  
**PINE** 7' | RL



**L BRB3**  
 3/4 x 2-1/2  
**PRIMED** 16'



**L 473 E2E**  
 19/32 x 2-1/4  
**MDF** 7'6" | 15'



**472 E2E**  
 9/16 x 2-1/2  
**PRIMED** 16'  
 19/32 x 2-1/2  
**MDF** 16'



**452 E2E**  
 11/16 x 2-1/2  
**PRIMED** 16'



**L 452 E1E**  
 11/16 x 2-1/2  
**PRIMED** 16'

# Casing



**312**  
19/32 x 3  
MDF 8'



**37**  
11/16 x 3-1/4  
PRIMED 16'



**445A**  
11/16 x 3-1/4  
MDF 16'



**445**  
19/32 x 3-1/4  
MDF 7'3" | 16'  
11/16 x 3-1/4  
PRIMED 7'3" | 16'  
PINE 8' | 16'



**682**  
1 x 3-1/4  
MDF 16'



**W 331**  
11/16 x 3-1/2  
PINE RL



**W C312**  
11/16 x 3-1/2  
PRIMED 16'

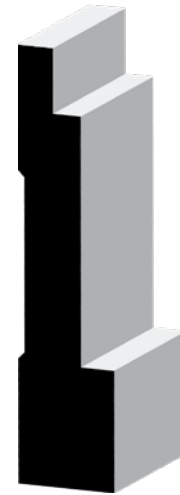

**STCA**  
13/16 x 3-1/2  
PRIMED 16'



**SCCA**  
13/16 x 3-1/2  
PRIMED 16'



**535**  
11/16 x 3-1/2  
MDF 16'  
5/8 x 3-1/2  
PRIMED 16'



**B G312**  
11/16 x 3-1/2  
PRIMED 16'



**L 361**  
11/16 x 3-1/2  
PRIMED 16'

# Casing



**L 412 E1E**  
11/16 x 3-1/2  
PRIMED 16'



**E 412 E2E**  
11/16 x 3-1/2  
PRIMED 8' | 16'



**412 E2E**  
19/32 x 3-1/2  
MDF 16'



**432 E2E**  
9/16 x 3-1/2  
PRIMED 16'

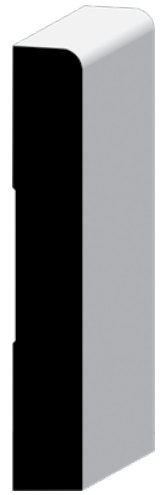

**L 432 E1E**  
9/16 x 3-1/2  
PRIMED 16'



**444**  
11/16 x 3-1/2  
PRIMED 7'3" | 16'



**444A**  
11/16 x 3-1/2  
MDF 16'



**M DC97**  
3/4 x 3-1/2  
PRIMED 16'



**DC97**  
1 x 3-1/2  
MDF 16'  
1-1/16 x 3-1/2  
PRIMED 7'4" | 16'



**RB3**  
1 x 3-1/2  
MDF 16'



**SRB3**  
1-1/16 x 3-1/2  
PRIMED 16'



**LK4 CASING**  
1-1/8 x 4  
MDF 16'



**5010 Architrave**  
1-3/16 x 4-1/4  
MDF 16'



## Decorative Craftsman Architraves

## ORNAMENTAL

DECORATIVE MILLWORK

A NOVO Building Products Company

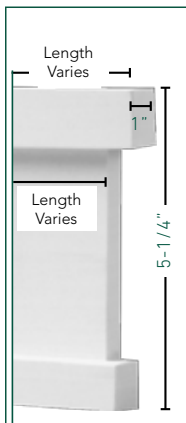

Description	Type / Finish	Actual Length	Used With	Empire SKU #
24" Craftsman Style Architrave	Primed Poplar	32-5/8"	24" Opening	CSHD 24 ORPMP
28" Craftsman Style Architrave	Primed Poplar	36-5/8"	28" Opening	CSHD 28 ORPMP
30" Craftsman Style Architrave	Primed Poplar	38-5/8"	30" Opening	CSHD 30 ORPMP
32" Craftsman Style Architrave	Primed Poplar	40-5/8"	32" Opening	CSHD 32 ORPMP
36" Craftsman Style Architrave	Primed Poplar	44-5/8"	36" Opening	CSHD 36 ORPMP



Scan to place orders on our NEW Empire Pro Dealer Portal  
[PRO.EMPIRECO.COM](http://PRO.EMPIRECO.COM)

# Rosettes | Plinth Blocks



**Bullseye Rosette**  
**B 642**  
 5/8 x 2-1/2  
 WHITE WOOD

**B 734**  
 27/32 x 3-1/2  
 WHITE WOOD

**B 740**  
 27/32 x 4-1/2  
 WHITE WOOD



**Floral Rosette - Beveled**  
**B 871**  
 1-1/16 x 3-1/2  
 WHITE WOOD

**B 915**  
 27/32 x 2-1/2  
 WHITE WOOD



**Bullseye Rosette - Beveled**  
**1400**  
 7/8 x 2-3/4  
 PRIMED

**1402**  
 7/8 x 3-3/4  
 PRIMED

**334**  
 7/8 x 3-3/4  
 MDF



**Star Rosette - Beveled**  
**B 1200**  
 1-1/16 x 3-1/2  
 WHITE WOOD



**Plinth Block - Beveled**  
**1401**  
 7/8 x 2-3/4 x 4-1/2  
 PRIMED

**1403**  
 7/8 x 3-3/4 x 6  
 PRIMED



**Plinth Block - Moulded**  
**B 887**  
 27/32 x 2-1/2 x 5-3/4  
 WHITE WOOD

**B 742**  
 1-1/16 x 3-1/2 x 6-1/2  
 WHITE WOOD

**334**  
 1 x 3-3/4 x 9  
 MDF

**B 743**  
 1-1/16 x 4-1/2 x 8  
 WHITE WOOD

# Corbels | Base Blocks



**C A8 ORCRW**  
**Decorative Corbel**  
 5-1/2 x 4-5/8 x 9-13/16  
 MAPLE



**C A8 ORPWH**  
**Decorative Corbel**  
 5-1/2 x 4-5/8 x 9-13/16  
 PAINTED WHITE



**CA60 ORPWH**  
**Decorative Corbel**  
 9 x 3-1/2 x 12  
 PAINTED WHITE



**C A110 ORMAP**  
**Shelf or Counter Bracket**  
 8 x 3 x 12  
 MAPLE



**CA70 ORMAP**  
**Classic Corbel**  
 6-1/2 x 3 x 12  
 MAPLE



**CA70 ORPWH**  
**Classic Corbel**  
 6-1/2 x 3 x 12  
 PAINTED WHITE



**Base Block -  
 Outside Corner**  
**B 892**  
 1-1/8 x 6-3/4  
 WHITE WOOD



**Base Block -  
 Outside Corner**  
**1892**  
 1-1/8 x 6-1/2  
 PRIMED



**Base Block  
 Inside Corner**  
**B 895**  
 7/8 x 6-3/4  
 WHITE WOOD



**Base Block  
 Inside Corner**  
**1895**  
 1-1/8 x 6-1/2  
 PRIMED

# Base Caps | Base



**B GC1**  
**Slant Cap**  
3/4 x 1-1/16  
PRIMED 16'

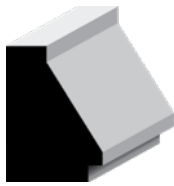

**B GC2**  
**Chamfer Cap**  
3/4 x 1-1/16  
PRIMED 16'



**163**  
**Base Cap**  
11/16 x 1-3/8  
MDF 16'  
PRIMED 16'  
PINE 12' | 16'



**8412**  
**Base Cap**  
5/8 x 1-3/8  
PRIMED 16'



**8416**  
**Base Cap**  
5/8 x 1-5/8  
PRIMED 16'



**L 433E E1E**  
1/2 x 3-1/4  
MDF 16'



**623**  
1/2 x 3-1/4  
MDF 8' | 16'  
9/16 x 3-1/4  
PRIMED 8' | 16'  
PINE 8' | 16'



**663**  
9/16 x 3-1/4  
PRIMED 8' | 16'  
PINE 8'



**713**  
9/16 x 3-1/4  
PRIMED 8' | 16'  
PINE 8' | 16'



**753**  
9/16 x 3-1/4  
PRIMED 16'



**L 432 E1E**  
9/16 x 3-1/2  
PRIMED 16'



**9750**  
11/16 x 3-1/2  
PRIMED 16'





**L 414 E1E**  
 9/16 x 4-1/4  
 PRIMED 8' | 16'



**620**  
 1/2 x 4-1/4  
 MDF 8' | 16'  
 9/16 x 4-1/4  
 PRIMED 8' | 16'  
 PINE 8'



**750**  
 9/16 x 4-1/4  
 PRIMED 16'



**163E**  
 19/32 x 5-1/4  
 MDF 8' | 16'  
 11/16 x 5-1/4  
 PRIMED 16'

**L 163E**  
 9/16 x 5-1/4  
 PINE 16'



**738**  
 9/16 x 5-1/4  
 PRIMED 8' | 16'



**618**  
 9/16 x 5-1/4  
 PRIMED 16'



**B 312**  
 19/32 x 5-1/4  
 MDF 16'

# Base



**750W**  
9/16 x 5-1/4  
PRIMED 16'



**L 514 E1E**  
9/16 x 5-1/4  
PRIMED 8' | 16'



**7055**  
19/32 x 5-1/4  
MDF 16'



**9243**  
3/4 x 5-1/4  
MDF 16'



**WB514**  
9/16 x 5-1/4  
PRIMED 16'



**B G512**  
9/16 x 5-1/2  
PRIMED 16'



**512E E1E**  
1/2 x 5-1/2  
MDF 16'



**256 BASE**  
11/16 x 5-1/2  
MDF 16'

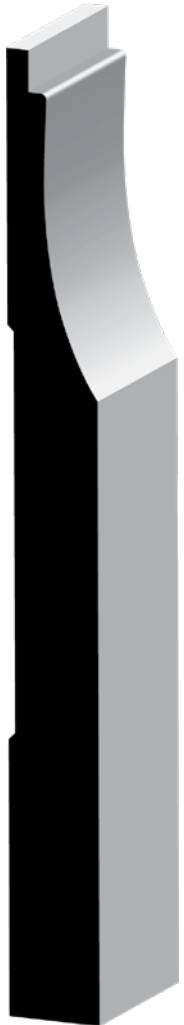

**SCBA**  
11/16 x 7  
PRIMED 16'



**STBA**  
11/16 x 7  
PRIMED 16'



**263**  
11/16 x 7  
MDF 16'



**7163**  
19/32 x 7-1/4  
MDF 16'

**7163E**  
11/16 x 7-1/4  
PRIMED 16'



**B G712**  
9/16 x 7-1/2  
PRIMED 16'

# Crown

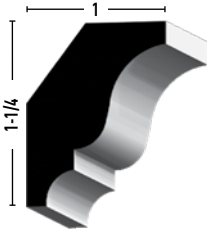

**68**  
9/16 x 1-5/8  
PRIMED 8' | 12'

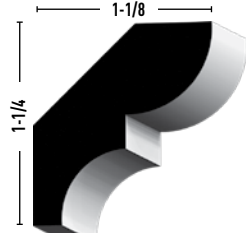

**75**  
9/16 x 1-5/8  
PRIMED 8' | 16'  
PINE 8' | 16'

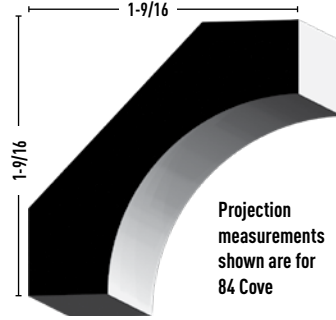

**84 Cove**  
9/16 x 2-1/4  
PINE RL

Projection  
measurements  
shown are for  
84 Cove

**86**  
9/16 x 1-5/8  
PINE 8' | 12' | 16'

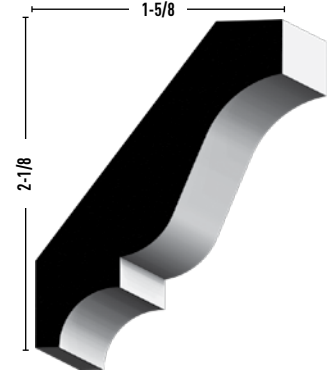

**53**  
9/16 x 2-5/8  
PRIMED 8' | 16'  
PINE 16'

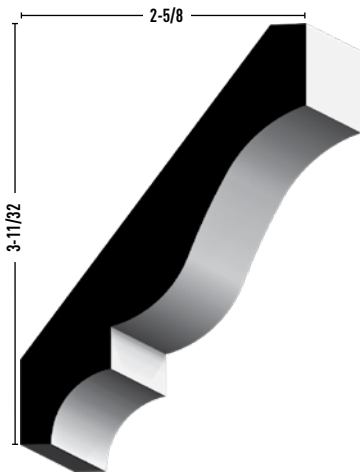

**L 49**  
19/32 x 3-5/8  
MDF 16'  
9/16 x 3-5/8  
PRIMED 16'  
PINE 8' | 12' | 16'

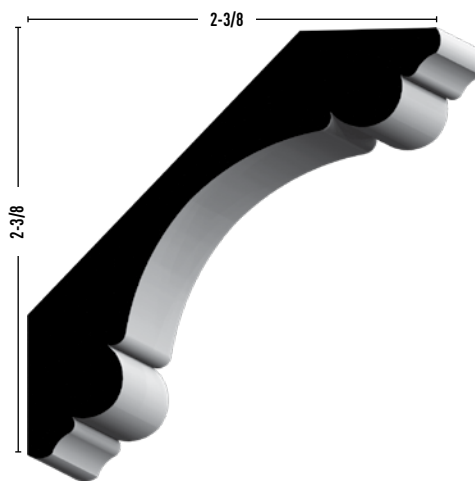

**L 340**  
11/16 x 3-3/8  
MDF 8' | 12'

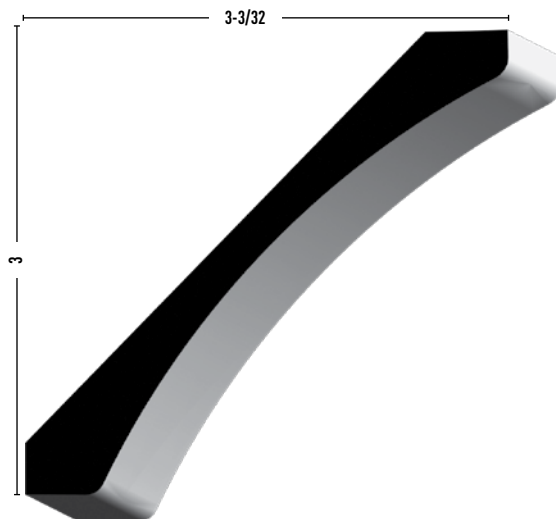

**E519**  
9/16 x 4-1/4  
MDF 16'

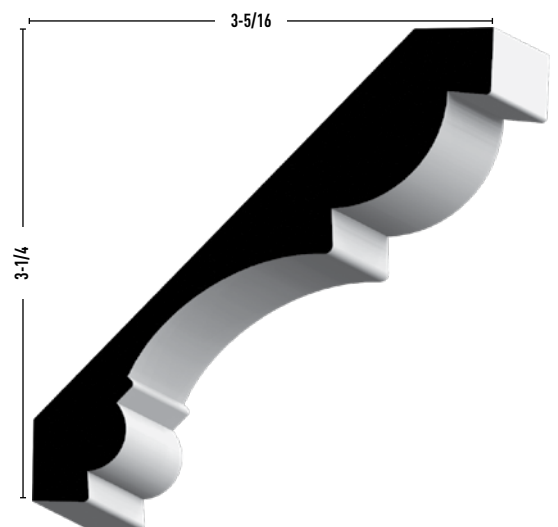

**185**  
11/16 x 4-5/8  
MDF 16'

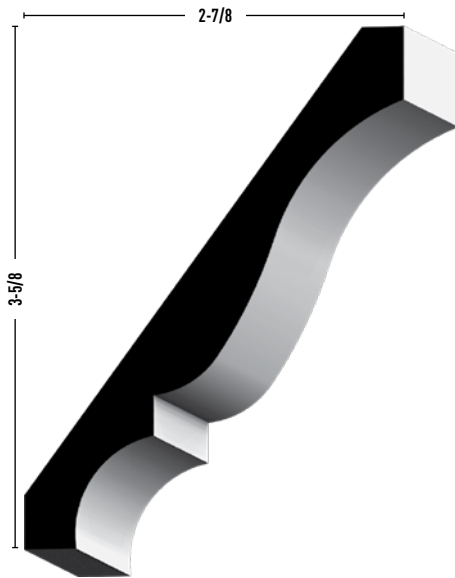

**L 47**  
 $19/32 \times 4-5/8$   
**MDF 16'**  
 $9/16 \times 4-5/8$   
**PRIMED 16'**  
**PINE 16'**

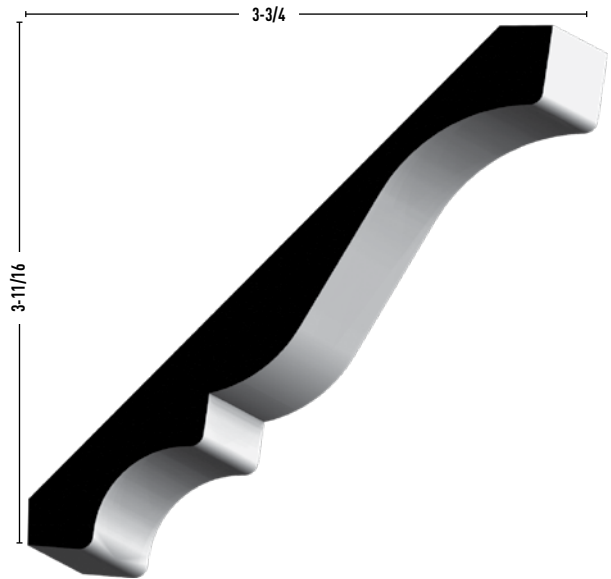

**L 45**  
 $19/32 \times 5-1/4$   
**MDF 16'**  
**N 45**  
 $11/16 \times 5-1/4$   
**PRIMED 16'**

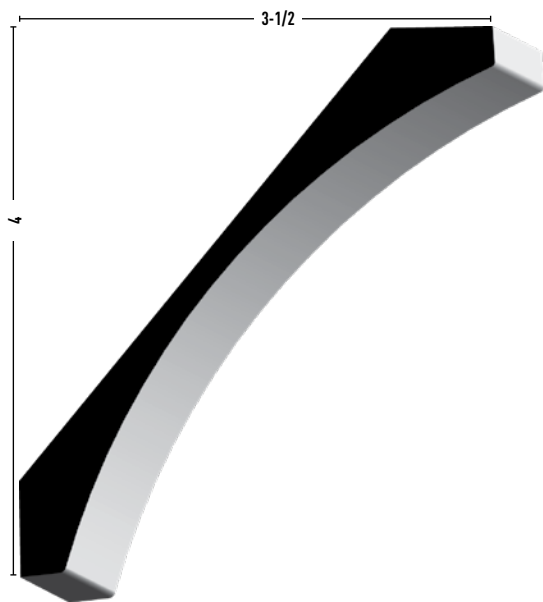

**CR291**  
 $3/4 \times 5-1/4$   
**MDF 16'**

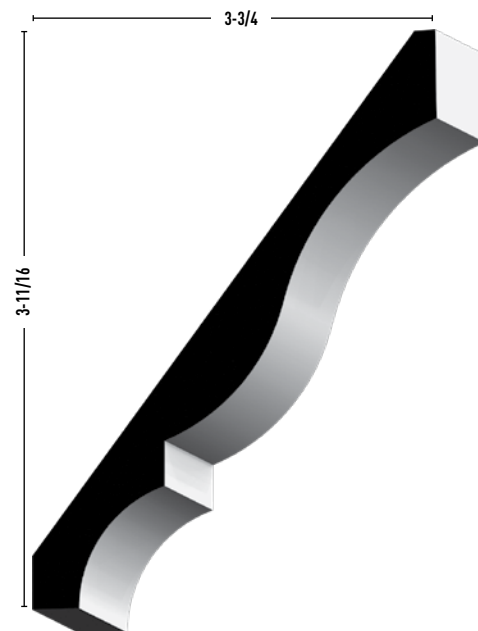

**L 46**  
 $9/16 \times 5-1/4$   
**PRIMED 16'**

# Crown

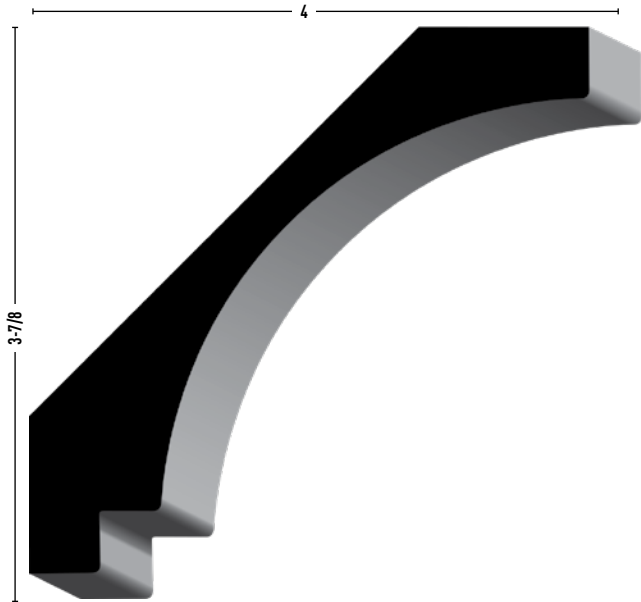

**530**  
1-3/16 x 5-1/2  
MDF 16'

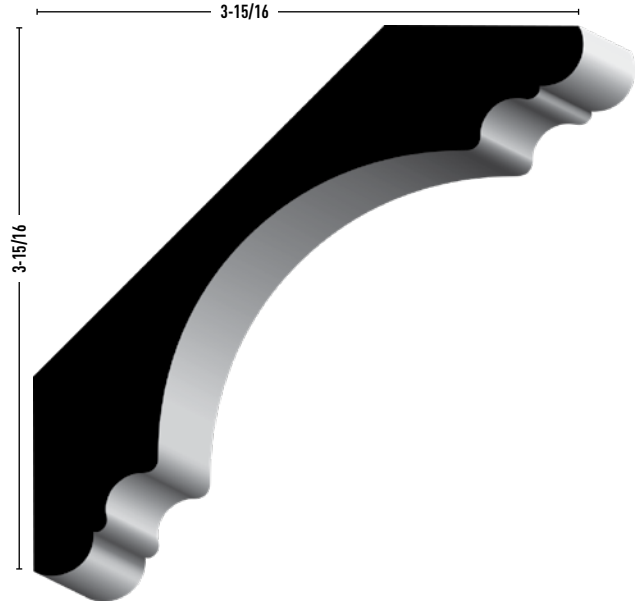

**EC512**  
1-3/16 x 5-1/2  
MDF 16'

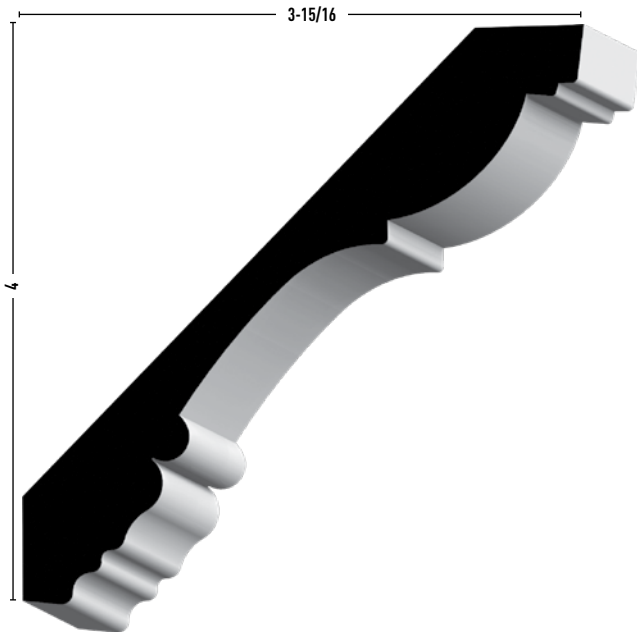

**L 201**  
13/16 x 5-5/8  
MDF 16'

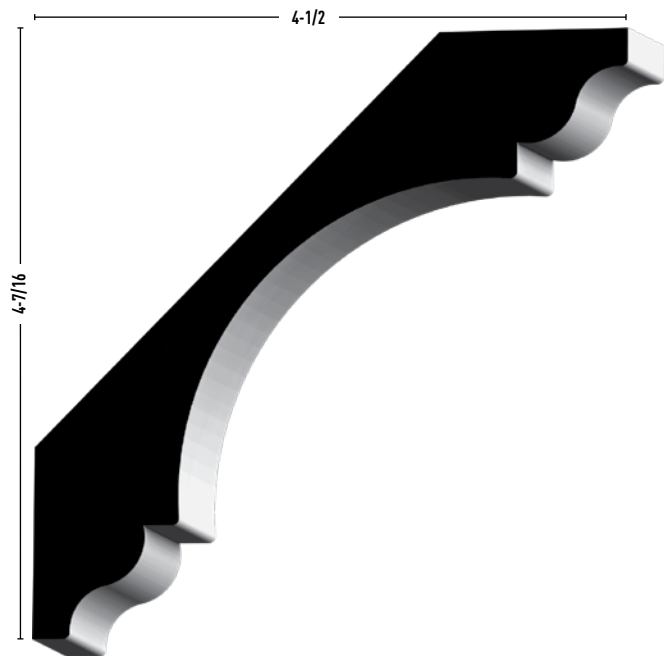

**041**  
1-3/16 x 6-5/16  
MDF 16'

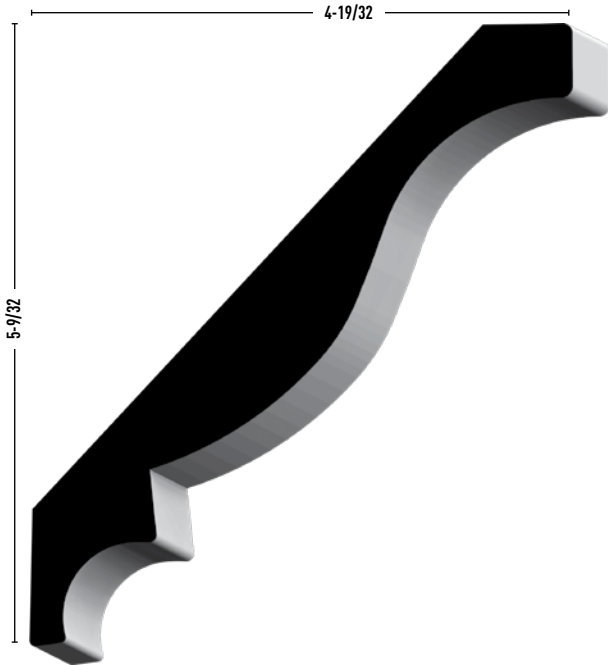

**043**  
1 x 6-15/16  
MDF 16'

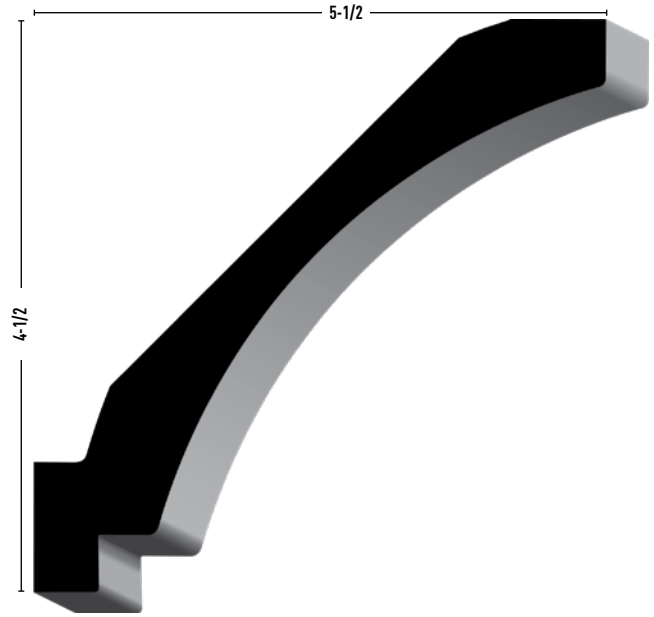

**730**  
1-3/16 x 7  
MDF 16'

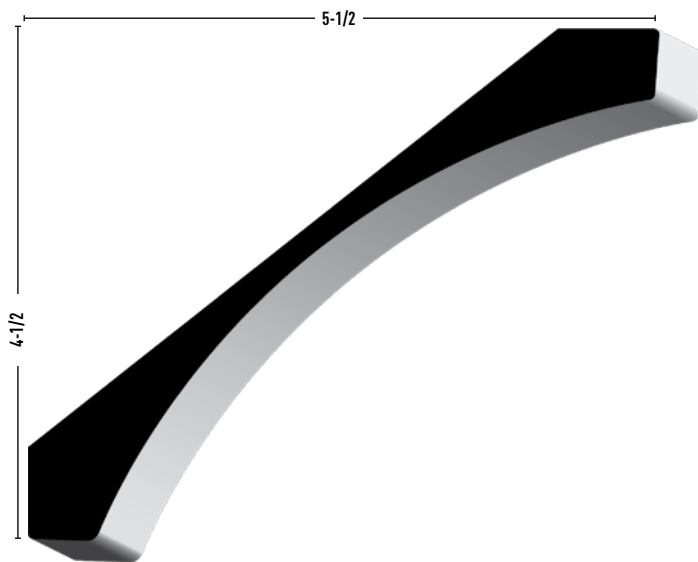

**505**  
1 x 7  
MDF 16'

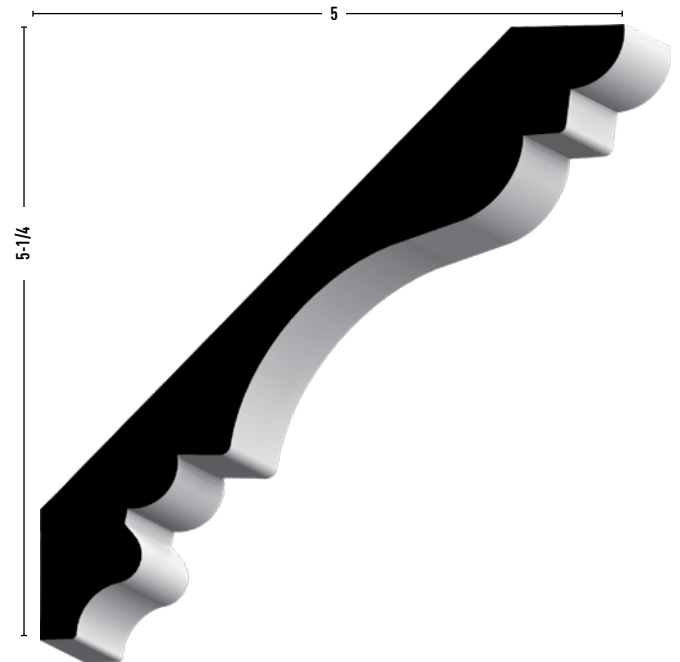

**721**  
1 x 7-1/4  
MDF 16'

# Crown Blocks

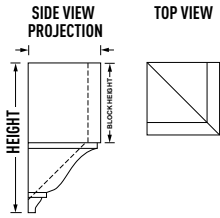

**Inside Corner**

**1888 - Medium**  
 2-5/8 x 2-5/8 x 5-5/8  
 PINE | PRIMED

**1898 - Medium**  
 3-1/8 x 2-27/32 x 5-7/8  
 WHITE WOOD

**1899 - Large**  
 4-3/16 x 3-11/16 x 7-3/4  
 WHITE WOOD

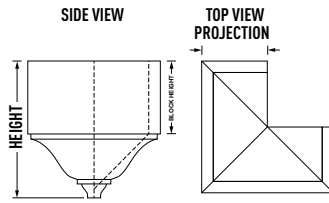

**Middle**

**1888 - Medium**  
 2-5/8 x 5-1/2 x 5-5/8  
 PRIMED

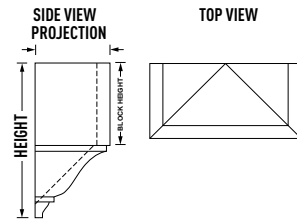

**Outside Corner**

**1888 - Medium**  
 5-5/8 x 7-3/4 x 6-1/4  
 PINE | PRIMED



**Inside Corner**

**1889 - Large**  
 3-1/2 x 3-1/2 x 7-1/2  
 PINE



**Outside Corner**

**1889 - Large**  
 7-1/2 x 10 x 8  
 PINE

# Wall Rails

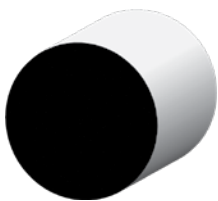

**L 232 Closet Pole**  
 1-1/2 Full Round  
 SPINE 8'

**L 233 Closet Pole**  
 1-1/4 Full Round  
 DFIR RL

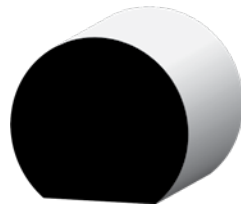

**231 Wall Rail**  
 1-1/2 x 1-11/16  
 DFIR 8' | 12'  
 SPINE 8' | 12' | 16'

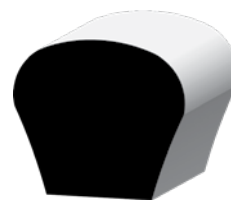

**230 Wall Rail**  
 1-1/2 x 1-11/16  
 SPINE 16'

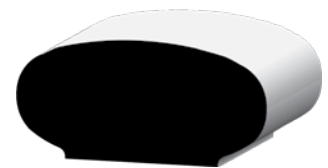

**240 Wall Rail**  
 1-1/4 x 2-1/4  
 SPINE 8' | 12' | 16'  
 PRIMED 16'



# Stools



**6 1021**  
19/32 x 6-1/2  
MDF 16'

**7 1021**  
19/32 x 7-1/4  
MDF 16'  
11/16 x 7-1/4  
PRIMED 16'



**358 Threshold**  
5/8 x 3-5/8  
OAK 37" | 73"



**458 Threshold**  
5/8 x 4-5/8  
OAK 37" | 73"



**1021**  
11/16 x 5-1/4  
MDF 16'  
PRIMED 8' | 16'



**4 1021**  
11/16 x 4-1/2  
PRIMED 16'

## Window & Door Miscellaneous



**180 Brick Mould**  
1-1/4 x 2  
PRIMED 7' | 10' | 17'  
PVC 18'



**1305 T-Astragal**  
1-1/4 x 2  
PRIMED 7' | 8'



**L 210 Shingle Mould**  
5/8 x 1-5/8  
PRIMED 16'



**142 Screen Mould**  
1/4 x 3/4  
PINE 8'



**2 Extension Mullion**  
1-1/4 x 2  
PRIMED 7'



**S 1196 Extension Jamb**  
11/16 x 2  
PRIMED 16'



**144 Beaded Screen Mould**  
1/4 x 3/4  
PINE 8'

# Stops



**888 E1E**  
3/8 x 1-1/8  
PRIMED 7'



**L 878 E2E**  
7/16 x 1-1/8  
PRIMED 8'3"



**L 888 E2E**  
3/8 x 1-1/8  
PRIMED 7'



**887 E1E**  
3/8 x 1-1/4  
MDF 7'



**876 E1E**  
7/16 x 1-3/8  
PRIMED 16'



**886 E1E**  
3/8 x 1-3/8  
PRIMED 7' | 16'  
PINE 7'



**947**  
3/8 x 1-1/4  
PRIMED 7'  
OAK 7'  
PINE 7' | 10'



**946**  
3/8 x 1-3/8  
PRIMED 7' | 16'  
PINE 7' | 10'  
MDF 7'



**936**  
7/16 x 1-3/8  
PRIMED 7' | 16'  
PINE 7'

# Mullions



**L 887 E2E**  
3/8 x 1-1/4  
OAK 7'  
PINE 7'



**L 983**  
3/8 x 1-5/8  
PINE 8'



**958**  
3/8 x 1-1/2  
PINE 8'

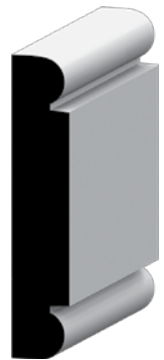

**956**  
3/8 x 2  
PINE 8'

# Panel Mould | Ply Caps



**183 Panel Mould**  
9/16 x 1-1/8  
PINE RL



**L 184 Panel Mould**  
1/2 x 1-1/2  
PRIMED 16'

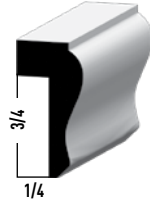

**292 Ply Cap**  
9/16 x 1-1/8  
PINE 8'

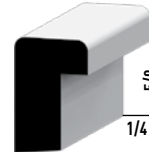

**280 Back Band**  
11/16 x 1-1/8  
PRIMED 16'

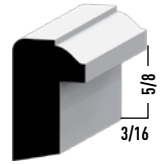

**281 Back Band**  
11/16 x 1-1/8  
PRIMED 16'  
PINE 8'

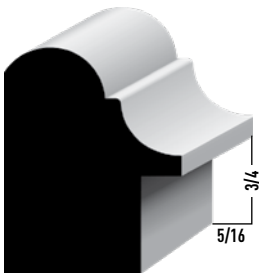

**L CAP EC**  
1-3/8 x 1-3/4  
PRIMED 16'



**1219 Ply Cap**  
11/16 x 1-5/8  
PINE 8'



**B G200 Bevel Nose Back Band**  
1-1/16 x 1-1/16  
PRIMED 16'

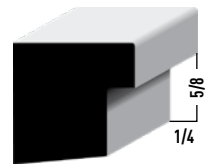

**B G250 Eased Nose Back Band**  
1-1/16 x 1-1/16  
PRIMED 16'

# Chair Rails



**390 Chair Rail**  
11/16 x 2-5/8  
PRIMED 8' | 16'  
PINE 8'



**297 Chair Rail**  
19/32 x 3  
MDF 16'  
11/16 x 3  
PRIMED 16'



**300 Chair Rail**  
1 x 3  
MDF 16'  
1-1/16 x 3  
PRIMED 16'



**956W Backer Bead**  
1/2 x 4-1/4  
MDF 16'



**L 956W Backer Bead**  
7/16 x 4-1/4  
PRIMED 16'

# Miscellaneous



**126 Shoe**  
 $1/2 \times 3/4$   
**PRIMED 12' | 16'**  
**OAK 8' | RL**  
**PINE 12' | 16'**



**103 Quarter Round**  
 $1-1/16 \times 1-1/16$   
**PINE RL**

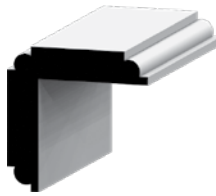

**202 Corner Guard**  
 $1-1/8 \times 1-1/8$   
**PINE 8'**

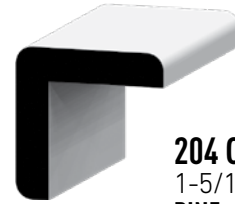

**204 Corner Guard**  
 $1-5/16 \times 1-5/16$   
**PINE 8'**

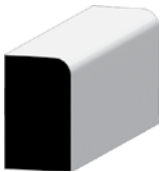

**L 254 Craftsman Shoe**  
 $7/16 \times 3/4$   
**PRIMED 16'**

**105**  
 $3/4 \times 3/4$   
**OAK 8'**  
**PINE 8' | RL**

**106**  
 $11/16 \times 11/16$   
**PRIMED 8' | 16'**  
**PINE 8' | 12' | 16'**

**108**  
 $1/2 \times 1/2$   
**PINE 8' | 16'**



**254 Parting Bead**  
 $1/2 \times 3/4$   
**PRIMED 16'**  
**PINE 16'**

**205**  
 $1-1/16 \times 1-1/16$   
**OAK 8'**  
 $1-1/8 \times 1-1/8$   
**PRIMED 8'**  
**PINE 8'**

**206**  
 $3/4 \times 3/4$   
**PINE 8'**



**144 Beaded Screen Mould**  
 $1/4 \times 3/4$   
**PINE 8'**



**5 263 Lattice**  
 $1/4 \times 5-1/4$   
**PINE RL**

**W 266**  
 $1/4 \times 1-5/8$   
**PINE 8'**

**L 266**  
 $1/4 \times 1-1/2$   
**PRIMED 8'**  
**PINE 8' | 10' | RL**

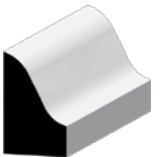

**131 Ogee Shoe**  
 $1/2 \times 3/4$   
**PRIMED 16'**



**122 Half Round**  
 $3/8 \times 11/16$   
**PINE 8'**



**142 Screen Mould**  
 $1/4 \times 3/4$   
**PINE 8'**

**L 267**  
 $1/4 \times 1-3/8$   
**PINE 8' | 16'**

**L 268**  
 $1/4 \times 1-1/8$   
**PINE 8' | RL**



**B G100 Shoe**  
 $5/8 \times 1$   
**PRIMED 16'**

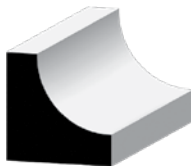

**93 Cove**  
 $3/4 \times 3/4$   
**OAK 8'**

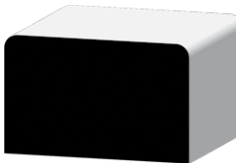

**2 Extension Mullion**  
 $1-1/4 \times 2$   
**PRIMED 7'**

**L 249 Screen Stock**  
 $1/2 \times 1-5/8$   
**PINE 8'**

**L 247**  
 $1/2 \times 2$   
**PINE 8'**



**995 Chamfer**  
 $3/4 \times 3/4$   
**PINE 8' | RL**

**100**  
 $11/16 \times 11/16$   
**PRIMED 16'**  
**OAK RL**  
**PINE 8' | 16'**



**S 1196 Extension Jamb**  
 $11/16 \times 2$   
**PRIMED 16'**

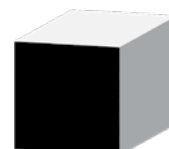

**239**  
 $3/4 \times 3/4$   
**PINE 8'**



**L CAP EC**  
 1-3/8 x 1-3/4  
**PRIMED 16'**  
 Use with ECB product



**B G312** Casing w/**B G200** Back Band Casing | **B G312** Base | **B G100** Shoe | **SL16** Shiplap



**SL18**  
**Tongue & Groove**  
**Shiplap**  
 11/16 x 7-1/4  
**MDF 16'**



**SL18**  
**Nickel Gap**  
**Shiplap**  
 5/8 x 7-1/2  
**PRIMED 16'**



**1X6 EC**  
**Wainscoting**  
 23/32 x 5-1/2  
**PRIMED 16'**



**SL16**  
**Tongue & Groove**  
**Shiplap**  
 11/16 x 5-1/4  
**MDF 16'**



**SL16**  
**Nickel Gap**  
**Shiplap**  
 5/8 x 5-1/2  
**PRIMED 16'**

Sizes and Profiles on PRIMED shiplap may vary slightly

**WARNING:** Drilling, sawing, sanding or machining wood products can expose you to wood dust, a substance known to the State of California to cause cancer. Avoid inhaling wood dust or use a dust mask or other safeguards for personal protection. For more information go to [www.P65Warnings.ca.gov/wood](http://www.P65Warnings.ca.gov/wood)



# Turncraft Columns & Porch Post

In-Stock and available for Quick Ship (Call and Check availability).  
 More styles and innovative Turncraft products available for special order at:  
**TURNCRAFT.COM**

## Round Poly Classic Columns (Cast FRP)

6 2742 TURNC	Tapered Column	8" x 8'
2 4244 TURNC		8" x 9'
6 2743 TURNC		8" x 10'
6 2744 TURNC		10" x 8'
2 4245 TURNC		10" x 9'
6 2745 TURNC		10" x 10'
7 6163 TURNC		Round Time Saver Cap & Base Set "install kit included"
7 6164 TURNC		10"
2 5063 TURNC	Foam Cap & Base Set Round	8"
2 5064 TURNC		10"

## Split Round Poly Classic Columns (Cast FRP)

6 2928 X TURNC	Split Tapered Column	8" x 8'
6 2930 X TURNC		10" x 8'
6 2931 X TURNC		10" x 10'
7 6307 X TURNC		EZ Lock Split Cap & Base Set
7 6308 X TURNC		10"



## Round Wood Tapered Columns

P 1088 TURNC	Tapered Primed Column	8" x 8'
F 1088 TURNC	Fluted Column	8" x 8'
7 2262 TURNC	Cap & Base Set for Wood Columns	8"
2510 TURNC		10"

## Timesaver Cap & Base

Turncraft's Timesaver Cap & Base offers the easiest and quickest installation in the industry



- Made out of fiber-reinforced recycled ABS (acrylonitrile butadiene styrene)
- Designed for use on round FRP columns in 8", 10", and 12" sizes
- Made with 95% recycled material
- Extremely strong and durable
- Self aligning with no fasteners
- Excellent paint adhesion
- Fast installation

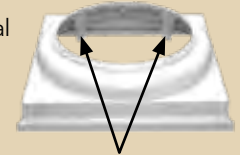

**Pressure Tabs**



## Wood Porch Post

D 3148 A TURNC	Post Defense W/Acrylic Prmr	4" x 8'
D 3059 A TURNC	Post Defense W/Acrylic Prmr	5" x 9'
D 3069 A TURNC	Post Defense W/Acrylic Prmr	6" x 9'
1 7004 UNVSL	Porch Post Fastener	4"
1 7005 UNVSL	Porch Post Fastener	5"
1 7006 UNVSL	Porch Post Fastener	6"

**\*Post Saver™ Mount Block required for warranty on wood porch post.**



# Turncraft Columns

## NEW Pro Series Square Columns (Cast FRP)

The New Square Pro-Series FRP Columns are lighter and cost less with the same load bearing capacities

- 5-14% price reduction over the standard square column
- 8-12% lighter weight than standard square FRP column
- Adjustable/removable neck mold on 8", 10" and 12" columns

0 9316 TURNC	Square Non-Tapered Column	8" x 8" x 8'
7 1000 TURNC		10" x 10" x 8'
7 3816 TURNC	Tuscan Cap & Base Set TimeSaver	8"
7 1110 TURNC		10"

## Duraglass Square Columns (Pultruded)

- Adjustable/removable neck mold on 8", 10" and 12" columns

7 3819 TURNC	Square Non-Tapered Column	8" x 8" x 8'
7 3821 TURNC		8" x 8" x 10'
7 3824 TURNC		10" x 10" x 8'
7 3826 TURNC		10" x 10" x 10'
0 9336 TURNC		12" x 12" x 12'
7 3816 TURNC	Tuscan Cap & Base Set TimeSaver	8"
7 1110 TURNC		10"
0 9350 TURNC	Tuscan Cap & Base Set FOAM	12"



## Duraglass Bungalow Square Tapered (Pultruded)

0 9479 TURNC	Tapered Square Column	12" x 8" x 5'
0 9480 TURNC		12" x 8" x 6'
0 9482 TURNC		16" x 12" x 5'
0 9483 TURNC		16" x 12" x 6'
0 9520 TURNC	Bungalow Tuscan Square Cap & Base	12"
0 9521 TURNC		16"

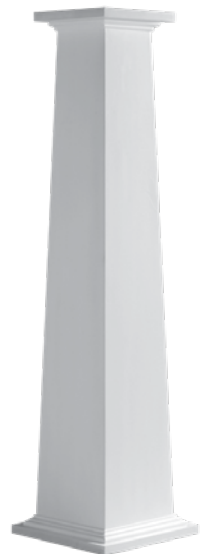

### TIP:

Visit: <https://turncraft.com/builder/> at **TURNCRAFT.COM** to access Turncraft's Column Builder tool to help visualize the column you wish to order.

# Moulding Index

Pattern	Pg #
2	45, 48
37	31
041	42
043	43
L 45	41
N 45	41
L 46	41
L 47	41
L 49	40
52	40
53	40
68	40
75	40
84	40
86	40
93	48
B G100	48
B100	32
100	48
103	48
105	48
106	48
108	48
122	48
126	48
131	48
142	45, 48
144	45, 48
163	36
L 163E	37
163E	37
180	45
183	47
L 184	47
185	40
B G200	47
L 201	42
202	48
204	48
205	48
206	48
L 210	44
B G212	30
230	44
231	44
L 232	44
L 233	44
239	48

Pattern	Pg #
240	49
L 247	48
L 249	48
B G250	47
L 254	48
254	48
256	38
263	39
5 263	48
W 266	48
L 266	48
L 267	48
L 268	48
280	47
281	47
292	47
297	47
300	47
B 312	37
B G312	31
W C312	31
312	31
327	30
W 331	31
331	30
334	34
L 340	40
L 356	30
356	30
358	45
L 361	31
361	30
366	30
366A	30
376	30
390	47
L 412	32
E 412	32
412	32
L 414	37
L 432	32, 36
432	32
L 433E	36
444	32
444A	32
L 445 (99)	32
445	31
445A	31

Pattern	Pg #
L 452	30
452	30
458	45
472	30
L 473	30
505	43
EC512	42
B G512	38
512E	38
L 514	38
W B514	38
E 519	40
520	48
530	42
535	31
618	37
620	37
623	36
633	36
B 642	34
663	36
682	31
B G712	39
713	36
721	43
730	43
B 734	34
738	37
B 740	34
B 742	34
B 743	34
750	37
750W	38
753	36
B 871	34
876	46
L 878	46
886	46
L 887	46
B 887	34
887	46
L 888	46
888	46
B 892	35
B 895	35
912	36
B 915	34
936	46

Pattern	Pg #
946	46
947	46
L 956W	47
956W	47
956	46
958	46
L 983	46
995	48
1021	45
4 1021	45
6 1021	45
7 1021	45
E 1035	48
1075	48
1163	45
S 1196	44, 45
B 1200	34
1219	47
1305	45
1400	34
1401	34
1402	34
1403	34
1889	44
1892	35
1895	35
1888	44
1897	44
1898	44
1899	44
5010	32
7055	38
7163	39
8412	36
8416	36
8578	47
9243	38
9750	36
1X6 EC	49
B GC1	36
B GC2	36
L CAP	47, 49
CR291	41
DC97	32
MDC97	32
LK4	32
L BRB3	30
S RB3	32

Pattern	Pg #
RB3	32
SCBA	39
SCCA	31
SL16	49
SL18	49
STBA	39
STCA	31
L WCAP	47
See page 22-25 for <b>Decorative Accessories</b> offerings.	
See page 27 for <b>Flexible Moulding</b> .	
See page 28 for <b>Board</b> offerings.	
See page 29 for <b>Jamb</b> offerings.	
See page 33 for <b>OMI Craftsman Architrave</b> offerings.	
See page 35 for <b>Corbel</b> offerings.	
See page 50-51 for <b>Columns</b> offerings.	