





Take hold of extraordinary

RDI® Railing is a premium railing brand offering unique features aimed at enhancing the look and livability of any home, all while delivering dramatically simplified installation. Available in a wide range of materials, designs and profiles, RDI Railing is a leading innovator in outdoor and indoor railing products. Featuring more than 20 patents and with more than 30 years of industry experience, RDI products deliver the versatility that brings your vision of home to life.



Live
Well
Outside

Together with our Oldcastle family of brands, we not only transform outdoor spaces, we transform the way families live in those spaces. By providing opportunities to connect, reflect and recharge, our goal is to help other Live Well Outside.

OldcastleAPG.com





Table of Contents

Elevation® Rail	4
Avalon Aluminum Railing®	8
MetalWorks Excalibur®	20
Privacy Rail™	28
Transform®	34
Bella Premier Series	42
Finyl Line™	50
Endurance® Original Rail™	62
Titan Pro Rail®	72
Vinyl ADA Handrail	80
Aluminum ADA Handrail	84
Lighting	88
Freestyle™ Complementary Accents	92
Decorative Screen Panels	94
Pergola	98
Lattice	100
EncloSure™ Screen System	102

Elevation® Rail



Elevation Rail in Matte Black.

Available in pre-assembled kits that can install 38% faster than the leading competition*, Elevation Rail requires no special tools or fasteners and features the OneTen™ built-in tensioning control system. With pre-strung cables and adjustable panels that span up to 6' wide, Elevation Rail offers unobstructed views and a continuous top rail for both level and stair applications.



OneTen™

The OneTen built-in tensioning control system eliminates the need to tension each cable individually and decreases the need for seasonal adjustments.

- Easy to shop with fewer SKUs to order
- Available in pre-assembled kits with pre-installed brackets and pre-strung stainless-steel cables
- Premium powder coating on aluminum framing meets or exceeds AAMA 2604 specifications
- Transferable Limited Lifetime Warranty on aluminum rails and posts and Limited Warranty on cable fittings



Matte Black

**Based on a 12' x 18' deck with 8 posts and 7 panels (Elevation Rail installed 49 minutes faster than competitive cable railing install of 129 minutes).*



How to Shop:

Level Rail Panels

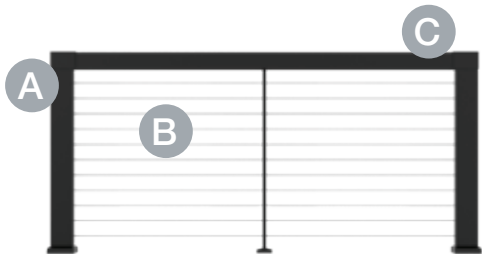

A Pick Your Posts

Pre-slotted end, mid, corner, 22.5 degree and 45 degree posts accept cable level rail panels. Post caps included for seamless panel transitions.

B Pick Your Rail Panel

Cable rail panel fits securely into posts and includes mid-rail support and OneTen tensioning system.

C Pick Your Beam Kit

Beam kit includes top beam and top rail to complete your panel. Add the deck board adapter to the top rail to accept a deck board (deck board sold separately).

Stair Rail Panels

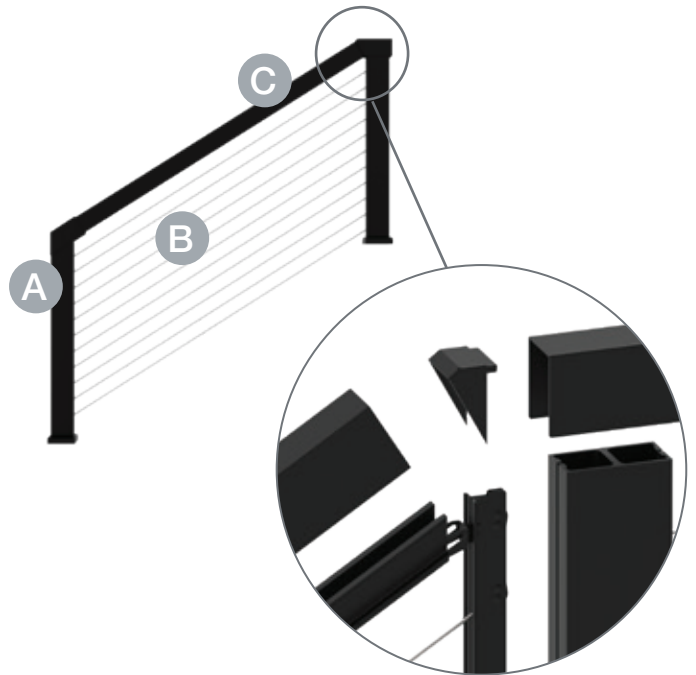

A Pick Your Posts

Pre-slotted stair end and mid cable posts accept cable stair rail panels. Post caps included for seamless panel transitions including adapter for transition from level to stair.

B Pick Your Rail Panel

Cable rail panel fits securely into posts and includes OneTen tensioning system.

C Pick Your Beam Kit

Beam kit includes top beam and top rail to complete your panel.

Cable Rail – Posts	
Description	Matte Black
2" x 4" x 36" End Post	73053488
2" x 4" x 36" Mid Post	73053489
4" x 4" x 36" Corner Post	73053490
45 Degree x 36" Corner Post	73056781
22.5 Degree x 36" Corner Post	73056783
2" x 4" x 38" End Stair Post	73053491
2" x 4" x 38" Mid Stair Post	73053492
2" x 4" x 42" End Post	73055543
2" x 4" x 42" Mid Post	73055544
4" x 4" x 42" Corner Post	73055545
45 Degree x 42" Corner Post	73056782
22.5 Degree x 42" Corner Post	73056784
2" x 4" x 44" End Stair Post	73055546
2" x 4" x 44" Mid Stair Post	73055547

Posts include post, connected base plate, trim ring and post cap.

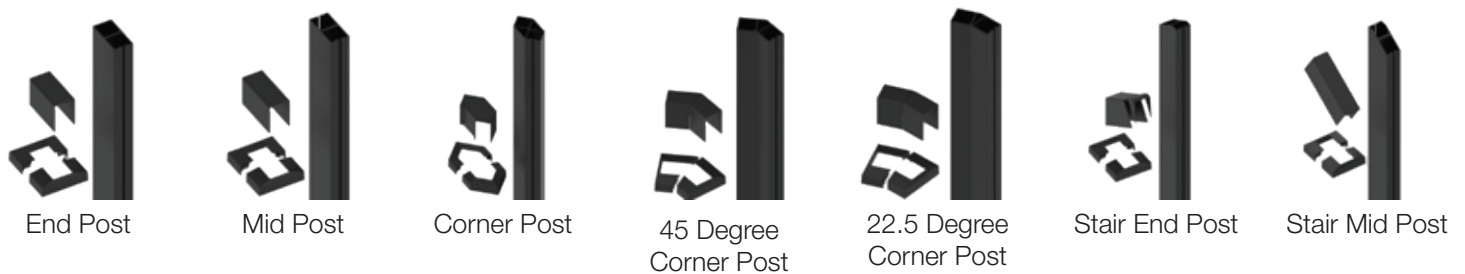

Cable Rail – Panels		
Description	36" Height	42" Height
6' Level Cable Panel	73053485	73055541
5' Stair Cable Panel (for stair angles 26 degrees to 38 degrees)	73053486	73055551

Level cable panels install at 72" on center of posts and includes cable infill section, center support and cable tensioner. Stair cable panels install at 60" on center of posts and include cable infill section, center support* and cable tensioner. Stair cable panels are designed to install on a stair section with a maximum of 5 risers. Top beam kit sold separately.

*Center support is included with 42" Stair Cable Panel only.



Cable Rail – Beam Kit and Adapter	
Description	Matte Black
6' Top Beam Kit	73053487
6' Deck Board Adapter – 2 Pack	73056785



Avalon Aluminum Railing®



Rust-resistant Avalon Aluminum Railing provides style, versatility and safety. The pre-assembled rail panels feature ProLock® locking strips that are designed to hold balusters securely in place. The ultimate in customization, Avalon Aluminum Railing offers three top rail options, including an adapter piece that easily creates a distinctive 3 rail design.



ProLock®

ProLock is a locking strip that secures railings by connecting them from the inside out to provide a clean design.

- Cable and glass slat infill options provide unobstructed views
- NEW unique horizontal rod rail design provides open views
- Panels with square balusters come pre-assembled
- Premium powder coating on aluminum framing meets and exceeds AAMA 2604 specifications
- Advanced weather testing, including 10,000 hours of salt spray testing
- Assembled in the USA with Transferable Limited Lifetime Warranty



Matte Black



Matte Bronze



White



How to Shop:

Cable Infill

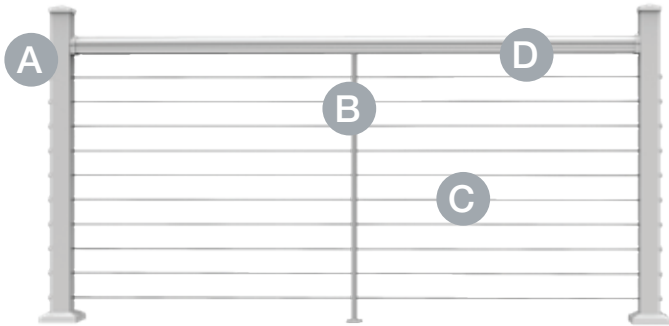

A Pick Your Posts

Routed cable posts – end, mid and corner options (includes base and post cap).

B Pick Your Beam Kit

Includes top beam, 4 brackets and mid-baluster support.

C Pick Your Infill

Cable with fitting – 10 needed for 36" finished heights, 12 needed for 42" finished heights. Available in 10', 20', 30', 50' and 70' lengths.

D Pick Your Top Rail

Required to complete installation – select from 3 styles.

Pre-Assembled Panels

(Square Balusters or Horizontal Rod Infill)

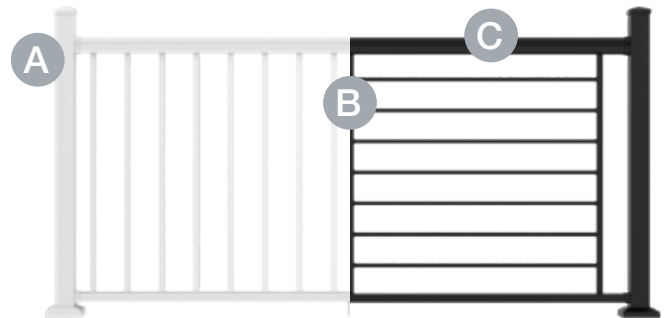

A Pick Your Posts

Aluminum posts – 2½" (includes base and post cap) or 4¼" (base and post cap sold separately) options.

B Pick Your Rail Panel

Pre-assembled level and stair rail sections. Includes 4 brackets and a support foot.

C Pick Your Top Rail

Required to complete installation – select from 3 styles.

Decorative Screen Panel Infill



A Pick Your Posts

Aluminum posts – 2½" (includes base and post cap) or 4¼" (base and post cap sold separately) options.

B Pick Your Beam Kit

Includes top beam, bottom rail, Decorative Screen Panel uprights, brackets and support foot.

C Pick Your Infill

3' x 6' Decorative Screen Panel infill – available in 4 styles and a variety of color combinations (sold separately).

D Pick Your Top Rail

Required to complete installation – select from 3 styles.

Glass Slats (Level Only)

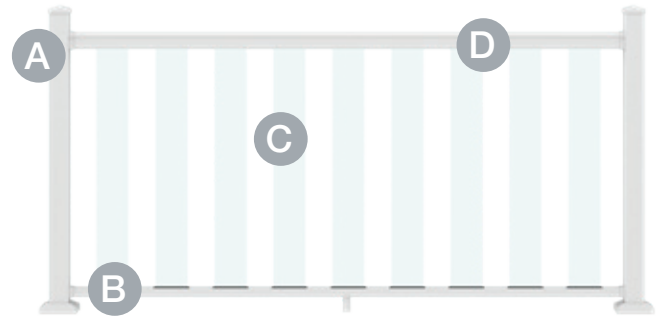

A Pick Your Posts

Aluminum posts – 2½" (includes base and post cap) or 4¼" (base and post cap sold separately) options.

B Pick Your Beam Kit

Available in 6' and 8' for 36" and 42" finished heights, level only. Includes 4 brackets and support foot.

C Pick Your Infill

Glass slat infill – 9 needed for 6' sections, 12 needed for 8' sections. Available for 36" and 42" finished heights, level only.

D Pick Your Top Rail

Required to complete installation – select from 3 styles.

Aluminum 2½" x 2½" Routed Cable Posts			
Description	White	Matte Black	Matte Bronze
2½" x 2½" x 39" End Post	73042977	73042976	73042978
2½" x 2½" x 39" Mid Post	73042983	73042982	73042984
2½" x 2½" x 39" Corner Post	73042995	73042994	73042996
2½" x 2½" x 39" Top Stair Post	73050039	73050038	73050040
2½" x 2½" x 42" Bottom Stair Post	73045616	73045615	73045617
2½" x 2½" x 42" Mid Stair Post	73050045	73050044	73050046
2½" x 2½" x 45" End Post	73042980	73042979	73042981
2½" x 2½" x 45" Mid Post	73042986	73042985	73042987
2½" x 2½" x 45" Corner Post	73042998	73042997	73042999
2½" x 2½" x 45" Top Stair Post	73050042	73050041	73050043
2½" x 2½" x 48" Bottom Stair Post	73045619	73045618	73045620
2½" x 2½" x 48" Mid Stair Post	73050048	73050047	73050049
2½" x 2½" x 52" Fascia End Post	73045622	73045621	73045623
2½" x 2½" x 52" Fascia Mid Post	73045628	73045627	73045629
2½" x 2½" x 52" Fascia Corner Post	73045625	73045624	73045626
2½" x 2½" x 52" Fascia Top Stair Post	73050051	73050050	73050052
2½" x 2½" x 55" Fascia Bottom Stair Post	73050079	73050077	73050080
2½" x 2½" x 55" Fascia Mid Stair Post	73050054	73050053	73050055

42" stair posts are designed to work with 39" top stair posts. 48" stair posts are designed to work with 45" top stair and level posts.

52" and 55" posts are for 42" fascia applications only which have a maximum span of 48".

Corner posts are limited to 2 or 40' to a run.



Routed End Post



Routed Mid Post



Routed Corner Post

Use end, mid and corner posts for level applications. End posts have routed holes through post to anchor fitting at an end run of cable. Stair and fascia posts are also available. Posts include post, connected base plate, sandwich plate, trim ring and post cap.

Cable Rail Beam Kits

Description	White	Matte Black	Matte Bronze
6' x 36" Level Rail Beam Kit for Cable Rail	73042965	73042964	73042966
8' x 36" Level Rail Beam Kit for Cable Rail	73042968	73042967	73042969
6' x 42" Level Rail Beam Kit for Cable Rail	73050027	73050026	73050028
8' x 42" Level Rail Beam Kit for Cable Rail	73050030	73050029	73050031
6' Stair Rail Beam Kit for Cable Rail	73050033	73050032	73050034
8' Stair Rail Beam Kit for Cable Rail	73050036	73050035	73050037

Stair beam kits can accommodate both 36" and 42" finished heights. See product instructions for details. Cable components and Top Rail sold separately. See page 16 for Top Rail styles.

Cable Components

Description	
10' Cable with Fitting – Package of 1	73042960
20' Cable with Fitting – Package of 1	73042961
30' Cable with Fitting – Package of 1	73042962
50' Cable with Fitting – Package of 1	73042963
70' Cable with Fitting – Package of 1	73050296
Level Cable Lacing Needle	73050056
Corner Cable Lacing Needle	73050057
Cable Release Key	73025484
Cable Gripper Tool – Package of 2	73050244
E-Z Clean Cable Cleaner and Protectant	73040274

For a finished rail height of 36", 10 packages of cable with fitting will be needed. For a finished rail height of 42", 12 packages of cable with fitting will be needed.

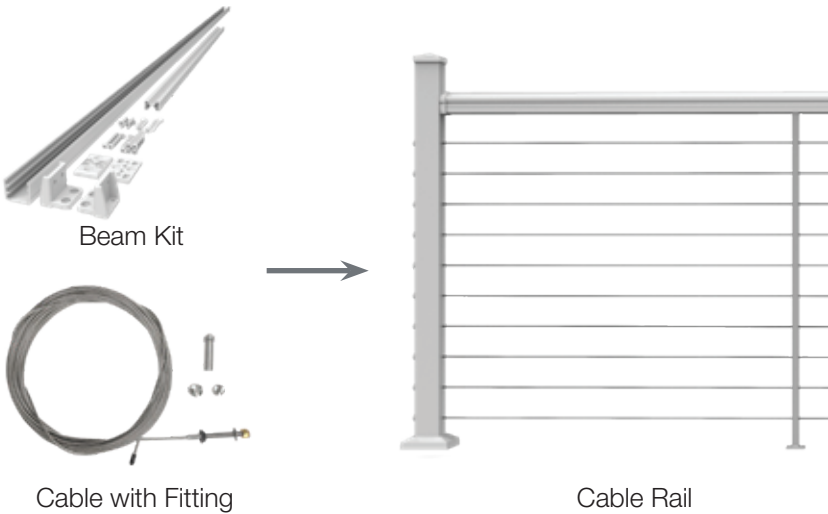

Aluminum 2½" x 2½" Posts			
Description	White	Matte Black	Matte Bronze
2½" x 2½" x 39" Standard Post	73043054	73043046	73043050
2½" x 2½" x 45" Standard Post	73043055	73043047	73043051
2½" x 2½" x 45" Heavy Duty Post	73043056	73043048	73043052
2½" x 2½" x 60" Heavy Duty Post	73043057	73043049	73043053
2½" x 2½" x 45" Fascia Mount Post*	73045504	73045503	73045505
2½" x 2½" x 52" Fascia Mount Post*	73045501	73045500	73045502
2½" x 2½" x 65" Post Extension	73050521	73050520	73050522

Standard and heavy duty posts include post, connected base plate, sandwich plate, trim ring and post cap.

*Brackets to install fascia mount posts for end, mid or corner applications sold separately. See page 18 for fascia brackets.

Post Extension fits into 2½" standard posts to extend the height of the post to allow for patio lights to be hung above the railing.

2" x 2" Over-the-Top Posts			
Description	White	Matte Black	Matte Bronze
2" x 2" x 33" Over-the-Top Post (for 36" finished height)	73020642	73020646	73019470
2" x 2" x 39" Over-the-Top Post (for 42" finished height)	73020643	73020647	73019471

Avalon panels must be cut up to 4" shorter than top rails pending install application. For 42" commercial height, over-the-top spans cannot exceed 5' in length between posts. Brackets sold separately – see page 18.

Aluminum 4¼" x 4¼" Posts/Sleeves			
Description	White	Matte Black	Matte Bronze
4¼" x 4¼" x 39" Post	73041379	73041378	73041376
4¼" x 4¼" x 45" Post	73041383	73041382	73041380
4¼" x 4¼" x 108" Porch Post – 5,000 lb capacity	73041375	73041374	73041372

4¼" x 4¼" x 108" post sleeves can be used as porch columns (5,000 lb load capacity); two mounting kits will be needed in this application.

Aluminum 4¼" x 4¼" Post/Sleeve Accessories			
Description	White	Matte Black	Matte Bronze
Flat Post Cap for 4¼" x 4¼" Posts	73041367	73041366	73041364
Trim Ring for 4¼" x 4¼" Posts	73041371	73041370	73041368
Mounting Kit for 4¼" x 4¼" Posts (includes trim ring and mounting plate)	73041363	73041362	73041360

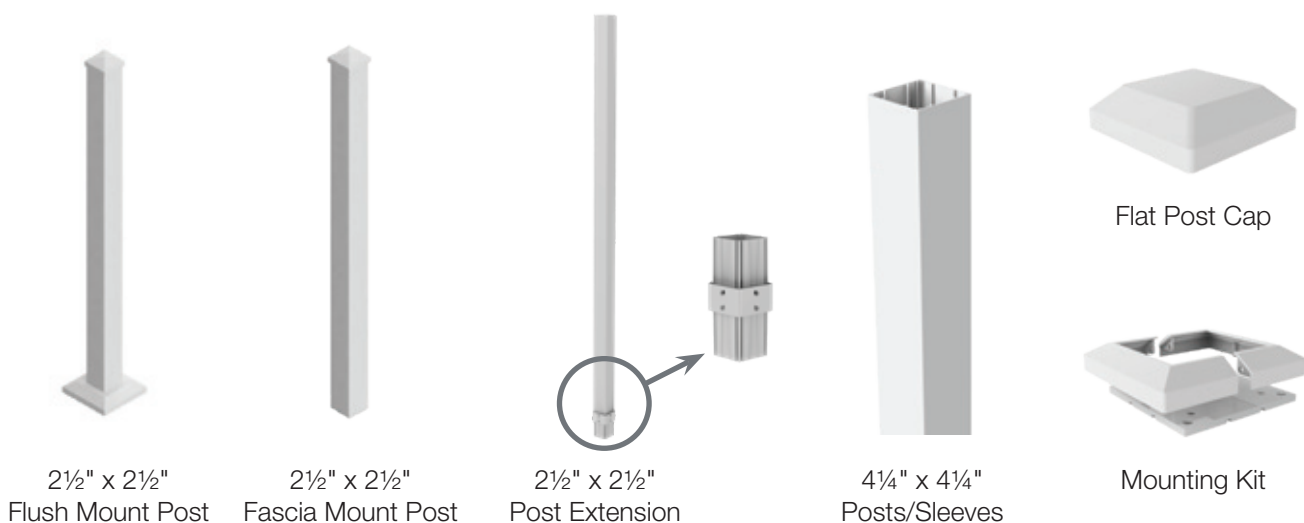

Pre-Assembled Panel – Square Balusters

Description	White	Matte Black	Matte Bronze
6' x 36" Level Rail Panel with Square Balusters	73019269	73019285	73019458
8' x 36" Level Rail Panel with Square Balusters	73019270	73019286	73019464
6' x 36" Stair Rail Panel with Square Balusters	73019271	73019287	73019466
8' x 36" Stair Rail Panel with Square Balusters	73019272	73019288	73019468
6' x 42" Level Rail Panel with Square Balusters	73019273	73019289	73019459
8' x 42" Level Rail Panel with Square Balusters	73019274	73019290	73019465
6' x 42" Stair Rail Panel with Square Balusters	73019275	73019291	73019467
8' x 42" Stair Rail Panel with Square Balusters	73019276	73019292	73019469

Pre-Assembled Panel – Horizontal Rod Infill – Matte Black Only

Description	36"	42"
6' Level Rail Panel with Horizontal Rod Infill	73056825	73056829
8' Level Rail Panel with Horizontal Rod Infill	73056826	73056830
6' Stair Rail Panel with Horizontal Rod Infill	73056827	73056831
8' Stair Rail Panel with Horizontal Rod Infill	73056828	N/A

Rail panels include bracket kit (two top and two bottom brackets) and support foot with mounting hardware. Top rail sold separately – see page 16.

2-to-3 Rail Adapter

Description	White	Matte Black	Matte Bronze
6' Rail Adapter	73050440	73050438	73050442
8' Rail Adapter	73050441	73050439	73050443

Adapter includes bracket kit (two mid rail brackets and hardware) with bracket covers and mounting hardware.

Glass Level Rail Kits

Description	White	Matte Black	Matte Bronze
6' Beam Kit for Glass Slats (level only)	73020648	73020652	73019454
8' Beam Kit for Glass Slats (level only)	73020649	73020653	73019460

6' kits require 9 glass slats and 8' kits require 12 glass slats (sold separately). Top beam, bottom rail, bracket kit (4 level brackets and mounting hardware), support foot and top and bottom gaskets for glass slats included with rail kits.

Glass Slats

Description	For 36" Rail Height	For 42" Rail Height
Glass Slats for Level Kits – Box of 9 – For Use with 6' Kits	73041331	73041332
Glass Slats for Level Kits – Box of 12 – For Use with 8' Kits	73041333	73041334



¾" Square Balusters



Horizontal Rod Infill



¾" Square Balusters with 2-to-3 Rail Adapter



4⅛" Glass Slats



Decorative Screen Panel Infill

Beam Kits for 3' x 6' Decorative Screen Panel Infill			
Description	White	Matte Black	Matte Bronze
6' x 36" Beam Kit for Decorative Screen Panels (sold separately)	73044011	73044009	73044010

Beam kits include top beam, bottom rail, 2 upright supports, bracket kit (4 level brackets and mounting hardware) and support foot.

3' x 6' Decorative Screen Panels				
Description	Boardwalk	Sanibel	River Rock	Optic
3' x 6' x 0.3" – White	73045664	N/A	N/A	N/A
3' x 6' x 0.3" – Gray	73045665	N/A	N/A	N/A
3' x 6' x 0.3" – Black	73030561	73050460	73045667	73050083

Actual size: 34" x 68" x 0.3".



Boardwalk



Sanibel
Design Patent Pending

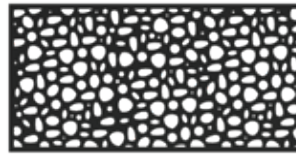

River Rock

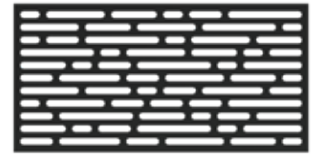

Optic

Decorative Screen Panels are designed with a matte, textured finish to allow them to be painted for complete customization.

Top Rails			
Description	White	Matte Black	Matte Bronze
6' Top Rail – Pellinore	73020442	73020448	73019456
8' Top Rail – Pellinore	73020443	73020449	73019462
6' Top Rail – Tristan	73020446	73020452	73019457
8' Top Rail – Tristan	73020447	73020453	73019463
6' Top Rail – Oberon*	73032049	73032042	73032048
8' Top Rail – Oberon*	73032052	73032050	73032051

Top Rails include 2 matching end covers.

*Oberon top rail is intended for level applications only. Deck board must be installed on top of Oberon profile.



Pellinore™



Tristan™

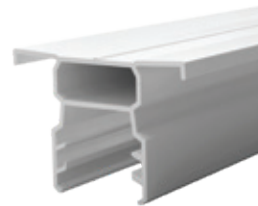

Oberon™*

Brackets

Description	White	Matte Black	Matte Bronze
Pellinore Level Bracket Kit (set of 4 – 2 top, 2 bottom)	73019301	73019298	73019490
Pellinore Stair Bracket Kit (set of 4 – 2 top, 2 bottom)	73019310	73019307	73019491
Pellinore Fixed Angle Stair Bracket (set of 4 – 2 top, 2 bottom)	73045480	73045479	73045481
Pellinore Angle Bracket Kit (set of 4 – 2 top, 2 bottom)	73019318	73019319	73019489
Tristan Level Bracket Kit (set of 4 – 2 top, 2 bottom)	73019300	73019297	73019496
Tristan Stair Bracket Kit (set of 4 – 2 top, 2 bottom)	73019309	73019306	73019497
Tristan Fixed Angle Stair Bracket (set of 4 – 2 top, 2 bottom)	73045483	73045482	73045484
Tristan Angle Bracket Kit (set of 4 – 2 top, 2 bottom)	73019315	73019316	73019495
Oberon Level Bracket Kit (set of 4 – 2 top, 2 bottom)	73040784	73040785	73040786

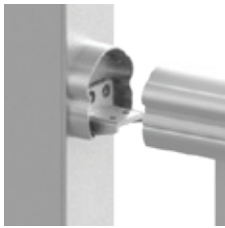

Level Brackets



Level Angle Brackets



Stair Brackets
(0 to 38 Degrees)



Fixed Angle Stair Brackets
(29 to 35 Degrees)

Brackets shown with Pellinore top rail and top rail end cover. Fixed angle stair brackets not available for Oberon.
 Typical new stair construction utilizes a 7" rise and an 11" run which results in a 32 degree stair angle.

Accessories

Description	
BracketPro™ Installation Jig – for use with 2", 2½" and 4¼" posts	73053555

Easily locates holes on posts to install brackets and provides level railing without having to measure or center brackets manually. For use with 2", 2½" and 4¼" posts.
 With 2" Over-the-Top posts, BracketPro can be used to locate the bottom brackets only.



BracketPro



2-to-3 Rail Brackets

Description	White	Matte Black	Matte Bronze
2-to-3 Rail Bracket Kit (2 mid rail brackets, covers and hardware)	73050446	73050444	73050445
2-to-3 Rail Angle Bracket Kit (2 mid rail brackets, covers and hardware)	73050449	73050447	73050448



2-to-3 Rail Bracket Kit



2-to-3 Rail Angle Bracket Kit

Over-the-Top Brackets

Description	White	Matte Black	Matte Bronze
Pellinore 2" Over-the-Top Post Bracket – Mid Post	73020663	73020681	73019487
Pellinore 2" Over-the-Top Post Bracket – Corner Post	73020664	73020682	73019486
Pellinore 2" Over-the-Top Post Bracket – End Post	73020665	73020683	73019488
Tristan 2" Over-the-Top Post Bracket – Mid Post	N/A	73020684	N/A
Tristan 2" Over-the-Top Post Bracket – Corner Post	N/A	73020685	N/A
Tristan 2" Over-the-Top Post Bracket – End Post	N/A	73020686	N/A
Oberon 2" Over-the-Top Post Bracket – Mid Post*	N/A	73040797	N/A
Oberon 2" Over-the-Top Post Bracket – Corner Post*	N/A	73040800	N/A
Oberon 2" Over-the-Top Post Bracket – End Post	N/A	73040787	N/A

*Does not include bracket covers; deck board will install over the top of Oberon top rail.



Mid Bracket



Corner Bracket

Style shown for use with Pellinore Top Rail



End Bracket

Fascia Bracket Kits

Description	White	Matte Black	Matte Bronze
Fascia Mount Mid Bracket Kit	73045489	73045488	73045490
Fascia Mount Outside Corner Bracket Kit	73045492	73045491	73045493
Fascia Mount Insider Corner Bracket Kit	73045495	73045494	73045496
Fascia Mount Juliette Bracket Kit	73045498	73045497	73045499
Fascia Mount Juliette Spacer*	73050297		

*Only necessary when Juliette application is using a fascia mid bracket and post.



Mid Bracket Kit



Outside Corner Bracket Kit



Inside Corner Bracket Kit



Juliette Bracket Kit



Fascia Mount Juliette Spacer

Gate Kits			
Description	White	Matte Black	Matte Bronze
36" Gate Kit	73020655	73020654	73019478
42" Gate Kit	73020658	73020657	73019479

Gate Kits include uprights, cross braces and gate kit hardware (2 hinges, 1 gravity latch – black only). Complete gate by purchasing rail panel and top rail separately. Gate kits cannot be used with Avalon glass or cable rail and cannot exceed widths of 48".



Gate Kit

Touch-Up Paint			
Description	White	Matte Black	Matte Bronze
Touch-Up Paint Aerosol (12 oz)	73022328	73044481	73044482
Touch-Up Paint Pen (1/2 fl oz)	73022351	N/A	N/A
Touch-Up Paint Bottle & Brush (1/2 fl oz)	N/A	73044483	73044484

LED lighting options are available for use with Avalon Aluminum Railing. For details and options, see page 80.



MetalWorks Excalibur[®]



MetalWorks Excalibur Steel Railing combines strength with a traditional and timeless style. Factory welded, fully assembled panels with hidden attachments and pre-attached brackets, allow for easy installation. Available in a traditional two rail design or in three decorative styles with textured matte black and hammered bronze finishes.

- Decorative infill styles offer custom looks
- MetalWorks Latitudes features unique horizontal rod design — provides open views
- Premium powder coating provides maximum durability
- Pre-attached brackets on posts make level installation easy and ensure consistent bottom spacing
- 15 Year Limited Warranty



Matte Black



Hammered Bronze



How to Shop:

Traditional Rail Panel

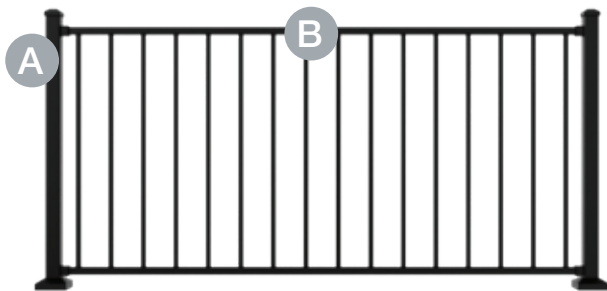

A Pick Your Posts

Bracketed posts available as end, mid and corner for 36" or 42" finished heights; includes welded base plates, pre-mounted post caps and two-piece trim ring. Blank posts (brackets sold separately) available for stair application and include welded base plates, pre-mounted post caps, and two-piece trim ring. Fascia posts available (brackets sold separately) and include pre-mounted post cap.

B Pick Your Rail Panel

Factory welded, fully assembled rail panel available for both stair and level applications in 36" and 42" finished heights.

Decorative Rail Panels (Level Only)

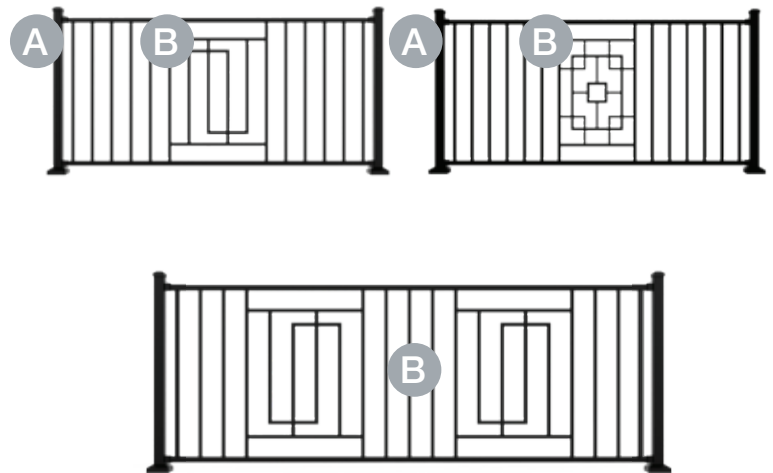

A Pick Your Posts

Bracketed posts available as end, mid and corner for 36" or 42" finished heights; includes welded base plates, pre-mounted post caps and two-piece trim ring. Blank posts (brackets sold separately) available for stair application and include welded base plates, pre-mounted post caps, and two-piece trim ring. Fascia posts available (brackets sold separately) and include pre-mounted post cap.

B Pick Your Rail Panel

Factory welded, fully assembled rail panel available for level applications in 36" and 42" finished heights.

Note: 8' wide versions differ for each style (Serpentine 8' style shown above).

Latitudes Horizontal Rail Panel

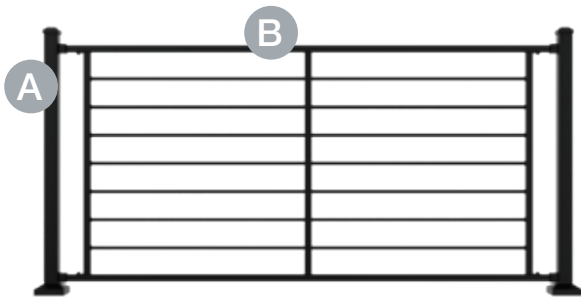

A Pick Your Posts

Bracketed posts available as end, mid and corner for 36" or 42" finished heights; includes welded base plates, pre-mounted post caps and two-piece trim ring. Blank posts (brackets sold separately) available for stair application and include welded base plates, pre-mounted post caps, and two-piece trim ring. Fascia posts available (brackets sold separately) and include pre-mounted post cap.

B Pick Your Rail Panel

Factory welded, fully assembled rail panel available for both stair and level applications in 36" and 42" finished heights.

2" x 2" Posts		
Description	Matte Black	Hammered Bronze
2" x 2" x 38" Mid Post Assembly for 36" Rail Height with 2" Bottom Space	73018345	N/A
2" x 2" x 38" End Post Assembly for 36" Rail Height with 2" Bottom Space	73018336	N/A
2" x 2" x 38" Corner Post Assembly for 36" Rail Height with 2" Bottom Space	73018326	N/A
2" x 2" x 44" Mid Post Assembly for 42" Rail Height with 2" Bottom Space	73018349	N/A
2" x 2" x 44" End Post Assembly for 42" Rail Height with 2" Bottom Space	73018339	N/A
2" x 2" x 44" Corner Post Assembly for 42" Rail Height with 2" Bottom Space	73018330	N/A
2" x 2" x 40" Mid Post Assembly for 38" Rail Height with 4" Bottom Space	73018347	N/A
2" x 2" x 40" End Post Assembly for 38" Rail Height with 4" Bottom Space	73018021	N/A
2" x 2" x 40" Corner Post Assembly for 38" Rail Height with 4" Bottom Space	73018023	N/A
2" x 2" x 38" Blank Post for 36" Rail Height (Brackets sold separately)	73018315	N/A
2" x 2" x 40" Blank Post for 38" Rail Height (Brackets sold separately)	73018317	N/A
2" x 2" x 44" Blank Post for 42" Rail Height (Brackets sold separately)	73018318	N/A
2" x 2" x 46" Blank Post for 44" Rail Height (Brackets sold separately)	73018320	N/A
2" x 2" x 48" Blank Post (Brackets sold separately)	73018322	N/A
2" x 2" x 52" Fascia Mount Post (Fascia brackets sold separately)	73019191	73019192

Posts include welded base plate, pre-mounted post top, brackets, bracket covers, two-piece trim ring and shims.

You may need to purchase a longer blank post for stair application depending on your installation scenario.

3" x 3" Posts		
Description	Matte Black	Hammered Bronze
3" x 3" x 38" Mid Post Assembly for 36" Rail Height with 2" Bottom Space	73044021	N/A
3" x 3" x 38" End Post Assembly for 36" Rail Height with 2" Bottom Space	73044020	N/A
3" x 3" x 38" Corner Post Assembly for 36" Rail Height with 2" Bottom Space	73044022	N/A
3" x 3" x 40" Mid Post Assembly for 38" Rail Height with 4" Bottom Space	73044024	73044030
3" x 3" x 40" End Post Assembly for 38" Rail Height with 4" Bottom Space	73044023	73044029
3" x 3" x 40" Corner Post Assembly for 38" Height Rail with 4" Bottom Space	73044025	73044031
3" x 3" x 40" Blank Post for 36" to 38" Rail Height (Brackets sold separately)	73032020	73032021
3" x 3" x 46" Blank Post for 36" to 44" Rail Height (Brackets sold separately)	73032022	73032023

Posts include welded base plate, pre-mounted post top, brackets, bracket covers, two-piece trim ring and shims.

You may need to purchase a longer blank post for stair application depending on your installation scenario.

2" x 2" Posts – California Only*		
Description	Matte Black	Hammered Bronze
2" x 2" x 44" Mid Post Assembly for 42" Rail Height with 4" Bottom Space	73018046	73018047
2" x 2" x 44" End Post Assembly for 42" Rail Height with 4" Bottom Space	73018044	73018045
2" x 2" x 44" Corner Post Assembly for 42" Height Rail with 4" Bottom Space	73018043	73018329

Posts include welded base plate, pre-mounted post top, brackets, bracket covers, two-piece trim ring and shims.

* These SKUs are CA code compliant and for distribution in CA only.



Mid Post



Corner Post



End Post



Blank Post

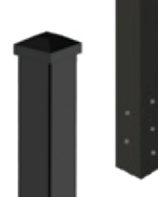

Fascia Post



Fascia Post shown with brackets

Traditional Rail Panels		
Description	Matte Black	Hammered Bronze
6' x 34" Level Rail Panel – Square Baluster	73018004	73018298
8' x 34" Level Rail Panel – Square Baluster	73018024	73018016
10' x 34" Level Rail Panel – Square Baluster*	73018015	73018291
6' x 34" Stair Rail Panel – Square Baluster	73018019	73018304
8' x 34" Stair Rail Panel – Square Baluster	73018310	73018311
6' x 40" Level Rail Panel – Square Baluster	73018299	N/A
8' x 40" Level Rail Panel – Square Baluster	73018018	N/A
8' x 40" Stair Rail Panel – Square Baluster	73018020	N/A

34" panels can be installed at a finished rail height of 36" with 2" bottom space or 38" with 4" bottom space. 40" panels can be installed at a finished rail height of 42" with 2" bottom space or 44" with 4" bottom space.

*10' panels can be used to cut down to shorter lengths or for long spans where code compliance is not required.

Traditional Rail Panels – California Only*		
Description	Matte Black	Hammered Bronze
6' x 38¼" Level Rail Panel – Square Baluster	73018030	73018031
8' x 38¼" Level Rail Panel – Square Baluster	73018032	73018033
6' x 32¼" Stair Rail Panel – Square Baluster	73018034	73018035
8' x 32¼" Stair Rail Panel – Square Baluster	73018036	73018309

* These SKUs are CA code compliant and for distribution in CA only.

Serpentine Rail Panels		
Description	Matte Black	Hammered Bronze
6' x 34" Serpentine Level Rail Panel – Square Baluster with Design	73045160	73045168
8' x 34" Serpentine Level Rail Panel – Square Baluster with Design	73045161	73045169
6' x 40" Serpentine Level Rail Panel – Square Baluster with Design	73045162	73045170
8' x 40" Serpentine Level Rail Panel – Square Baluster with Design	73045163	73045171

Mosaic Rail Panels		
Description	Matte Black	Hammered Bronze
6' x 34" Mosaic Level Rail Panel – Square Baluster with Design	73045156	73045164
8' x 34" Mosaic Level Rail Panel – Square Baluster with Design	73045157	73045165
6' x 40" Mosaic Level Rail Panel – Square Baluster with Design	73045158	73045166
8' x 40" Mosaic Level Rail Panel – Square Baluster with Design	73045159	73045167

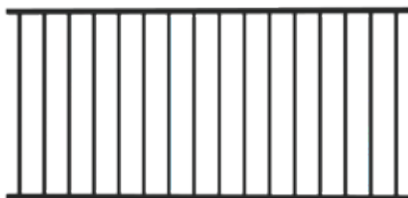

Traditional

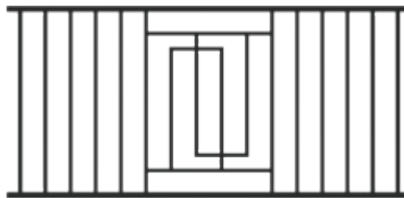

Serpentine

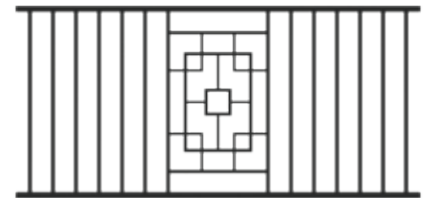

Mosaic

Latitudes Rail Panels		
Description	Matte Black	Hammered Bronze
6' x 34" Latitudes Level Rail Panel – Horizontal Round Rails	73044057	N/A
8' x 34" Latitudes Level Rail Panel – Horizontal Round Rails	73044089	N/A
6' x 34" Latitudes Stair Rail Panel – Horizontal Round Rails	73044087	N/A
6' x 40" Latitudes Level Rail Panel – Horizontal Round Rails	73044058	N/A
8' x 40" Latitudes Level Rail Panel – Horizontal Round Rails	73044086	N/A
6' x 40" Latitudes Stair Rail Panel – Horizontal Round Rails	73044088	N/A

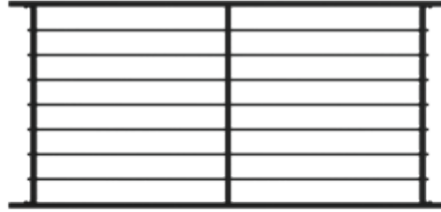

Latitudes

Brackets		
Description	Matte Black	Hammered Bronze
Bracket Kit for Level Rail (set of 4 – 2 top and 2 bottom brackets)	73018013	73018025
Bracket Kit for Stair or Level Angle Rail (set of 4 – 2 top and 2 bottom brackets)	73018014	73018026
Imperial Decorative Bracket for Level Rail* (set of 4 – 2 top and 2 bottom brackets)	73044946	73044947
Scrollwork Decorative Bracket for Level Rail* (set of 4 – 2 top and 2 bottom brackets)	73044948	73044949
Fascia Post Bracket Kit – For 2" Posts Only (set of 2 – mounting hardware not included)	73019193	73019194

* Decorative brackets come with hardware to attach to either wooden posts or steel posts.



Level Brackets

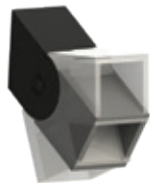

Stair/Angle Brackets



Imperial Brackets



Scrollwork Brackets



Fascia Brackets

Accessories		
Description	Matte Black	Hammered Bronze
Top Cap Flush Bracket Kit (set of 4)	73018886	73018887
Rail Cutting Jig	73018283	



Flush Mount Bracket

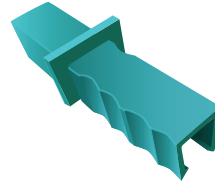
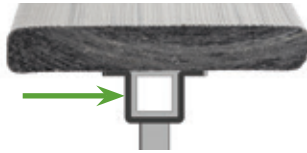

Rail Cutting Jig



Gates		
Description	Matte Black	Hammered Bronze
34" x 36" Gate, Assembled for 36"– 38" Rail – 36" Finished Opening	73018268	N/A
Gate Ends for 36"– 38¼" Rail – Custom Width – Rail Panel Sold Separately	73018276	73018277
Gate Ends for 42" Rail – Custom Width – Rail Panel Sold Separately (CA only)	73018278	73018279
Gate Ends for 42"– 44" Rail – Custom Width – Rail Panel Sold Separately	73018280	N/A
Compact Butterfly Hinge Kit Pair (Black aluminum)	73024441	
Gravity Latch (Black steel)	73024440	



Pre-Assembled Gate



Gate Ends

Touch-Up Paint	
Description	Matte Black
Touch-Up Paint Aerosol (12 oz)	73044481
Touch-Up Paint Bottle & Brush (½ fl oz)	73044483

Cut rail ends may be painted with any zinc-rich primer or paint. For Matte Black touch-ups, touch-up paint or Rust-Oleum® Satin Canyon Black, color code 249844 is recommended. For Hammered Bronze touch-ups, we recommend Rust-Oleum® Hammered Brown, color code 210880*.

*Rust-Oleum® is a registered trademark of Rust-Oleum Brand Company.

LED lighting options are available for use with MetalWorks Excalibur. For details and options, see page 80.

Privacy Rail™



Privacy Rail provides a contemporary and modern look for decks or patios while offering the option of increased privacy for outdoor spaces. Powder coated aluminum framing provides strength and stability while a selection of vinyl infill boards lock securely together using our patented ClickConnect™ technology.



ClickConnect™

ClickConnect is a patented connecting system that locks vinyl infill boards tightly together to create a railing panel that meets code compliance.

- Premium powder coating on aluminum rail kits and posts meets and exceeds AAMA 2604 specifications
- Advanced weather testing, including 10,000 hours of salt spray testing
- Vinyl infill boards lock securely together and fit tightly in post channels
- Adapter kit available to add Decorative Screen Panels to framing
- Assembled in the USA with Transferable Lifetime Limited Warranty

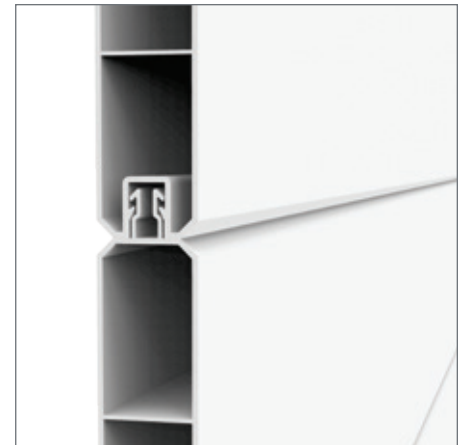

Aluminum Frame Colors

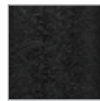

Matte Black



White

Vinyl Infill Board Colors



White



Clay



Sand



Slate Gray



Coastal Cedar

NEW for 2025



How to Shop:

Full Privacy Panel with Vinyl Infill Boards

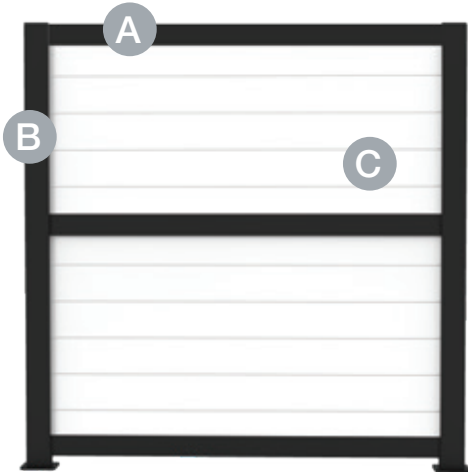

A Pick Your Rail Kit

Includes top, bottom, mid rails and post inserts for vinyl infill boards.

B Pick Your Posts

72" posts for full privacy height – available as end, corner and mid posts.

C Pick your Infill Boards

Vinyl infill boards for full privacy (requires a total of 11 boards – either 5 or 6 on top or bottom).

Full Privacy Panel with Decorative Screen Panel AND Vinyl Infill Boards

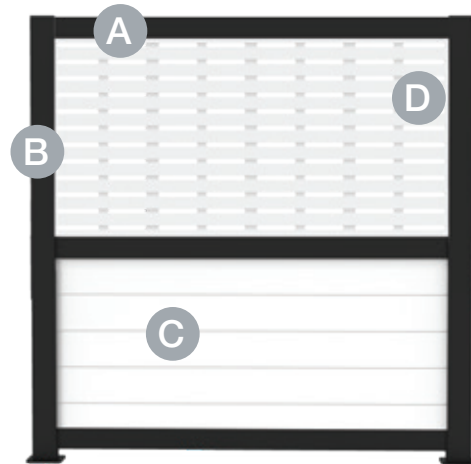

A Pick Your Rail Kit

Includes top, bottom, mid rails and post inserts for vinyl infill boards.

B Pick Your Posts

72" posts for full privacy height – available as end, corner and mid posts.

C Pick your Infill Boards

Vinyl infill boards for full privacy (requires a total of 11 boards – either 5 or 6 on top or bottom).

D Decorative Screen Panel

Adapter Kit for Decorative Screen Panel – includes post inserts for 3' x 6' Decorative Screen Panels (sold separately).

Half Privacy Panel with Vinyl Infill Boards



A Pick Your Rail Kit

Includes top and bottom rails and post inserts for vinyl infill boards.

B Pick Your Posts

42" post height for half privacy – can be installed for 42" finished height or cut down for 36" finished height. Available as corner, mid and end posts.

C Pick your Infill Boards

Vinyl infill boards for half privacy – 5 needed for 36" finished height, 6 needed for 42" finished height.

Rail Kits		
Description	White	Matte Black
6' Wide Full Privacy Rail Kit (includes top rail, bottom rail and mid rail)	73042844	73042828
6' Wide Half Privacy Rail Kit (includes top rail and bottom rail)	73042845	73042827

Full Privacy Rail kits include top and bottom rails and mid rail. Half Privacy Rail kits include top and bottom rail. Infill boards sold separately.

Full privacy panel requires 11 infill boards, half privacy requires 5 for 36" finished height or 6 for 42" finished height. An installed section using 2 end posts measures a finished width of 6'. If advanced wind load (check local codes) requirements are necessary, then full privacy railing (6' tall) must have post spacing every 3'.

Adapter Kits for Decorative Screen Panels		
Description	White	Matte Black
3' x 6' Privacy Rail Adapter Kit (includes top, bottom and side insert adapters)	73044016	73044015

Adapter kit allows 3' x 6' Decorative Screen Panels (sold separately) to be used as infills (can be used on top or bottom of Full Privacy Rail Kit, or with Half Privacy Rail Kit).



Full Privacy Panel
(with vinyl infill boards)



Full Privacy Panel (with Decorative
Screen Panel and vinyl infill boards)



Half Privacy Panel
(with vinyl infill boards)

Vinyl Infill Boards

Description	
6" x 66" Vinyl Infill Boards for 6' Width – Pack of 6 – White	73042846
6" x 66" Vinyl Infill Boards for 6' Width – Pack of 6 – Clay	73054363
6" x 66" Vinyl Infill Boards for 6' Width – Pack of 6 – Sand	73043491
6" x 66" Vinyl Infill Boards for 6' Width – Pack of 6 – Slate Gray	73055864
6" x 66" Vinyl Infill Boards for 6' Width – Pack of 6 – Coastal Cedar	73056795

Select color availability may vary. Please check with your dealer for full color availability.

3' x 6' Decorative Screen Panels

Description	Boardwalk	Sanibel	River Rock	Optic
3' x 6' x 0.3" – White	73045664	N/A	N/A	N/A
3' x 6' x 0.3" – Gray	73045665	N/A	N/A	N/A
3' x 6' x 0.3" – Black	73030561	73050460	73045667	73050083

Actual size: 34" x 68" x 0.3".



Boardwalk



Sanibel
Design Patent Pending

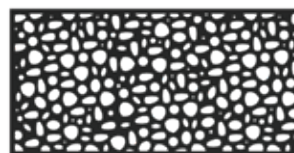

River Rock

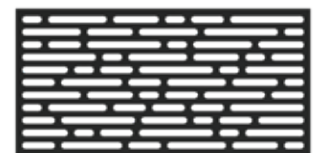

Optic

Decorative Screen Panels are designed with a matte, textured finish to allow them to be painted for complete customization.

Posts		
Description	White	Matte Black
2" x 4" x 42" End Post – Surface Mount	73042839	73042834
2" x 4" x 42" Mid Post – Surface Mount	73042840	73042832
3.3" x 3.3" x 42" Corner Post – Surface Mount	73042838	73042833
2" x 4" x 72" End Post – Surface Mount	73042842	73042837
2" x 4" x 72" Mid Post – Surface Mount	73042843	73042835
3.3" x 3.3" x 72" Corner Post – Surface Mount	73042841	73042836

Posts come with pre-mounted base plates, 2-piece trim rings, infill board adapters*, post hardware covers, channel cover** and flat caps.

*42" posts do not include 27" infill adapter channels.

** 36" channel cover included in 72" posts only for a finished look transitioning from full to half privacy.



2" x 4" End Post



2" x 4" Mid Post



3.3" x 3.3" Corner Post

A post is needed at each end of your Privacy Rail panels. End posts can also be used to transition from privacy to our vinyl or aluminum railing. 42" posts can be used for half privacy sections 36" or 42", and 72" posts are used for full privacy sections.

Gate Kits		
Description	White	Matte Black
42" Height Gate Kit for Widths 36" – 48"	73045453	73044980
72" Height Gate Kit for Widths 36" – 48"	73045454	73044981
Gravity Latch	73025491	73028060
Two-Sided Locking Latch	73050188	73050187

Gate kits include uprights, top and bottom rails and gate hinges. 42" gate kits include compact butterfly hinges and 72" gate kit includes heavy-duty hinges, color matched to gate. Purchase your gate latch separately. Infill boards sold separately; 6 boards needed for 42" high gate kits and 11 boards needed for 72" high gate kits. Boards and rails must be cut to desired width for finished gate width (36" to 48").



Full Privacy Gate (72")



Half Privacy Gate (42")

Touch-Up Paint		
Description	White	Matte Black
Touch-Up Paint Aerosol (12 oz)	73022328	73044481
Touch-Up Paint Pen (1/3 fl oz)	73022351	N/A
Touch-Up Paint Bottle & Brush (1/2 fl oz)	N/A	73044483

Transform[®]



Transform Composite Railing has the look and feel of a wood railing, but provides superior resistance to moisture, mold and warping. Made with Compositore® — a material that contains no wood or organic fibers — Transform features a lightly textured, durable finish.



Compositore®

Compositore used in our railing products, contains no wood fibers, making it water resistant meaning it will not rot, splinter, warp or stain and is resistant to mold — keeping your railing beautiful for years to come.

- Does not warp, splinter or rot — easy to maintain with long lasting color retention
- Universal bracket for level, stair or angled applications
- Mix and match with aluminum or steel railing for custom look
- Hidden brackets provide a clean, finished look
- Made in the USA with Transferable Limited Lifetime Warranty

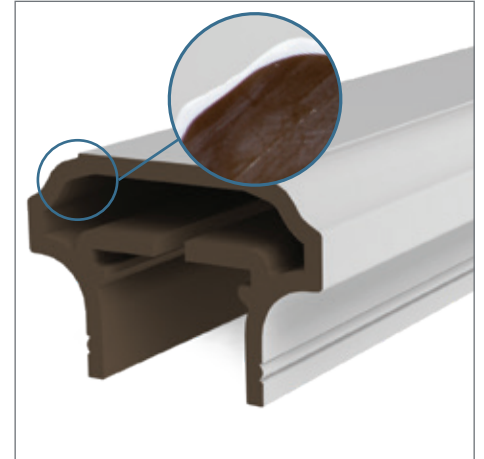

Satin White



Satin Black



Transform railing in Satin Black with square balusters and Emerge top rail.

How to Shop:

Full Rail Kits (Satin White Only)

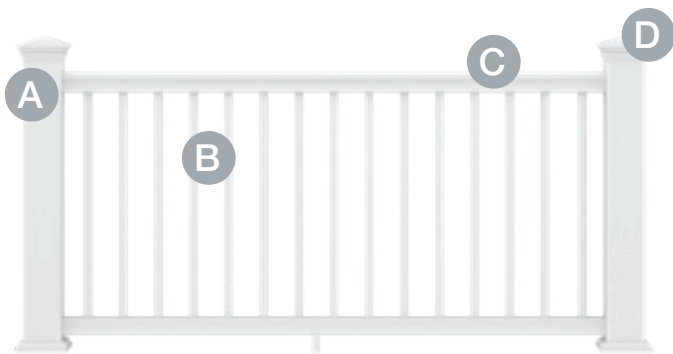

A Pick Your Posts

Post sleeves available for wooden 4" x 4" or structural posts.

B Pick Your Rail Kit

Includes top and bottom beams, bottom rail, brackets, square balusters and support foot.

C Pick Your Top Rail

Required for installation – choose from 4 styles.

D Pick Your Accessories

Post accessories include post caps in both standard and LED styles and trim rings.

Beam and Baluster Kits

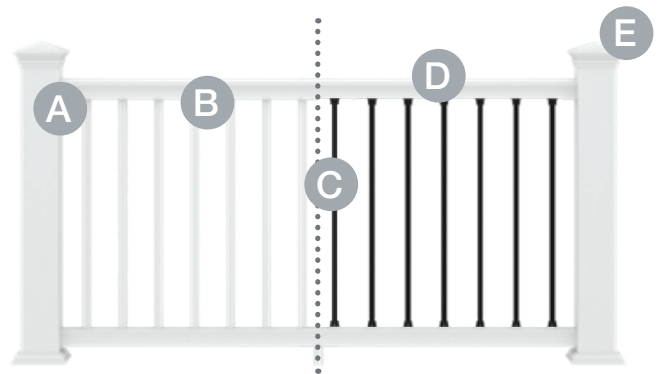

A Pick Your Posts

Post sleeves available for wooden 4" x 4" or structural posts.

B Pick Your Beam Kit

Includes top and bottom beams, bottom rail, brackets and support foot.

C Pick Your Infill

Choose from square or black round aluminum. Square balusters include baluster plugs; baluster shoes for black round aluminum sold separately.

D Pick Your Top Rail

Required for installation – choose from 4 styles.

E Pick Your Accessories

Post accessories include post caps in both standard and LED styles and trim rings.

Cable Rail Infill

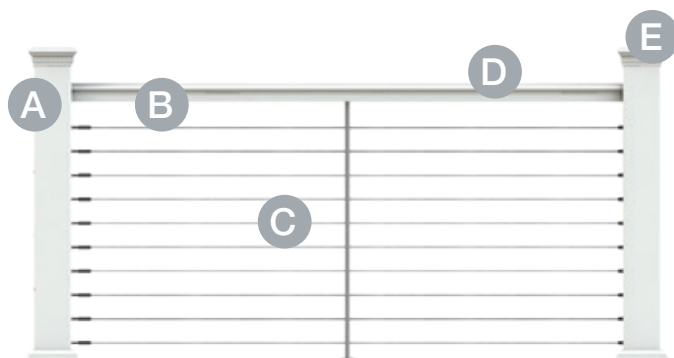

A Pick Your Posts

Post sleeves and wooden 4" x 4" posts required for cable install.

B Pick Your Beam Kit

Includes top and bottom beams, bottom rail, brackets and mid baluster support. Bottom rail is optional for installation.

C Pick Your Infill

Cable fittings (10 for a 36" finished height, 12 for a 42" finished height, and cable wire (100' spool or 500' spool).

D Pick Your Top Rail

Required for installation – choose from 4 styles.

E Pick Your Accessories

Post accessories include post caps in both standard and LED styles and trim rings.

Mix and Match

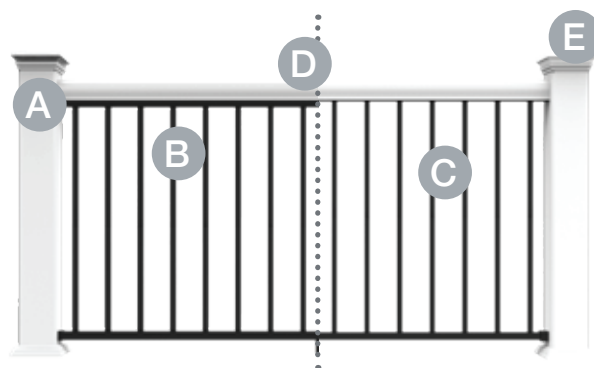

A Pick Your Posts

Post sleeves available for wooden 4" x 4" or structural posts.

B Avalon Aluminum Railing®

Avalon Rail Panels with Tristan top rail allows for a Transform top rail to be installed on top.

C MetalWorks Excalibur®

For MetalWorks Excalibur, a top rail adapter is available to install a Transform top rail on an Excalibur panel.

D Pick Your Top Rail

Required for installation – choose from 4 styles.

E Pick Your Accessories

Post accessories include post caps in both standard and LED styles and trim rings.

Structural Posts		
Description	Flush Mount	Fascia Mount
Structural Post for 36" Railing Height	73019022	73019023
Structural Post for 42" Railing Height	73019024	73019025
5" x 5" Post Inserts*	73019139	

Post Sleeves		
Description	Satin White	Satin Black
5" x 5" x 39" Post Sleeve – Boxed	73014245	73055865
5" x 5" x 54" Post Sleeve – Boxed	73014244	73055866
5" x 5" x 120" Post Sleeve – Boxed	73014246	N/A



Structural Post –
Flush Mount



Structural Post –
Thru/Fascia Mount



Post Insert



Post Sleeve

*Post sleeves come with two 5" x 5" post inserts; more can be purchased for use when sleeving 4" x 4" wooden posts with the 120" post sleeve cut to size.

Post Caps & Trim Rings		
Description	Satin White	Satin Black
5" x 5" Pinnacle Post Cap	73019127	73055867
5" x 5" Pinnacle LED Post Cap (0.80W)	73019361	73055868
5" x 5" Zenith Post Cap	73004495	73055869
5" x 5" Zenith LED Post Cap (0.80W)	73019365	73055870
5" x 5" Trim Ring	73019038	73055881



Pinnacle Post Cap



Pinnacle LED
Post Cap

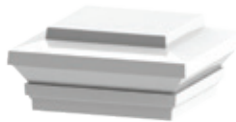

Zenith Post Cap

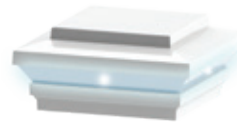

Zenith LED
Post Cap

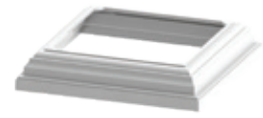

Trim Ring

Rail Kits	
Description	Satin White
6' x 36" Level Rail Kit with Square Balusters	73019032
8' x 36" Level Rail Kit with Square Balusters	73019033
6' x 42" Level Rail Kit with Square Balusters	73019035
8' x 42" Level Rail Kit with Square Balusters	73019036
6' x 36" Stair Rail Kit with Square Balusters	73019034
6' x 42" Stair Rail Kit with Square Balusters	73019037

Rail kits include balusters, top and bottom beams, bottom rail, brackets, support foot and hardware. Top rail sold separately.

Beam Kits – for Level or Stair		
Description	Satin White	Satin Black
6' Beam Kit for Square or Round Balusters	73019061	73055882
8' Beam Kit for Square or Round Balusters	73019062	73055883
6' Beam Kit for Cable Rail	73019347	73055884
8' Beam Kit for Cable Rail	73019348	73055885

Cable Rail must be installed using a 4" x 4" wooden post to support the cable tension. Bottom rail included in beam kits, but optional for cable installation.

Beam kits include top and bottom beams, bottom rail, brackets, support foot, mid-baluster support (cable rail kits only) and hardware. Top rail and balusters sold separately.



1 1/8" Square Balusters



3/4" Black Round Aluminum Balusters



1/8" Cable Rail Infill

1 1/8" Square Balusters		
Description	Satin White	Satin Black
36" Square Baluster – Level – 10 Pack	73019045	73055886
42" Square Baluster – Level – 10 Pack	73019046	73056142
36" Square Baluster – Stair (32 Degree) – 10 Pack	73019047	73055887
42" Square Baluster – Stair (32 Degree) – 10 Pack	73019048	73056143

15 balusters needed for a 6' kit, 20 balusters needed for an 8' kit.

3/4" Round Aluminum Balusters & Accessories	
Description	Black
36" Round Aluminum Baluster – 10 Pack	73019041
42" Round Aluminum Baluster – 10 Pack	73019042
Aluminum Baluster Shoes – Level – (box of 20 for 10 balusters)	73019043
Aluminum Baluster Shoes – Stair – (box of 20 for 10 balusters – for angles from 32 degree to 38 degree)	73019044

15 balusters needed for a 6' kit, 20 balusters needed for an 8' kit.

Cable Rail Infill & Accessories		
Description	Level	Stair
Cable Fitting for 36" Finished Height Installation – Box of 20 (10 sets of fittings)	73019357	73019358
Cable Fitting for 42" Finished Height Installation – Box of 24 (12 sets of fittings)	73019359	73019399
Cable Wire – 100' Length Spool	73019360	
Cable Wire – 500' Length Spool	73019381	
Cable Release Key	73025484	
E-Z Clean Cable Cleaner and Protectant	73040274	

Cable Rail must be installed using a 4" x 4" wooden post to support the cable tension. Bottom rail included in beam kits, but optional for cable installation.

Top Rails		
Description	Satin White	Satin Black
6' Transform Top Rail – Aspire	73019069	73055888
8' Transform Top Rail – Aspire	73019070	73055889
6' Transform Top Rail – Emerge	73019080	73055890
8' Transform Top Rail – Emerge	73019081	73055891
6' Transform Top Rail – Presence	73019088	73055892
8' Transform Top Rail – Presence	73019089	73055893
6' Transform Graspable Top Rail – For Stairs	73019009	73055894



Presence®



Emerge®

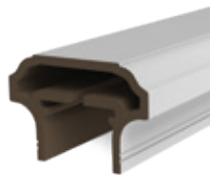

Aspire®



Graspable Stair

For 45 degree angle railing, the Emerge top rail can be cut at 45 degrees and installed. If using the Presence or Aspire top rail, the two adjacent rail sections must be cut at 22.5 degrees and installed on posts mounted at 22.5 degrees. Please contact our customer service department at 1-877-265-2220 for more information.

Gate Kits	
Description	Satin White
36" Gate Kit	73019237
42" Gate Kit	73019241



Gate kits include 2 uprights, 2 white cross braces, black Barrette Outdoor Living hardware (2 hinges, 1 latch). Rail section and top rail sold separately. Gates cannot exceed 48" in opening width.

Lighting Accessories		
Description	Satin White	Satin Black
5" x 5" Pinnacle LED Post Cap (0.80W)	73019361	73055868
5" x 5" Zenith LED Post Cap (0.80W)	73019365	73055870
Dome Light (0.80W) – SATIN WHITE	73019407	
Stair/Side Light (0.40W) – SATIN WHITE	73019414	
Flush Deck Light (0.40W)	73019403	
LED Under-Rail Lighting (92" strip – 3W)	73019376	
Bluetooth Transformer for LED Lighting	73041277	
Electrical Wire for LED Lighting – 2'	73032449	
Electrical Wire for LED Lighting – 5'	73019375	
Electrical Wire for LED Lighting – 7'	73019373	
Electrical Wire for LED Lighting – 9'	73019374	
2-Way Splitter	73019370	
5-Way Splitter	73019371	

Transformer is 50W and can be used with lighted post caps or under-rail lighting. Includes photocell, built-in dimmer, timer, remote and is Bluetooth capable. Download the "SmartPower50" app from the App Store or Google Play to control your lighting via your smartphone.

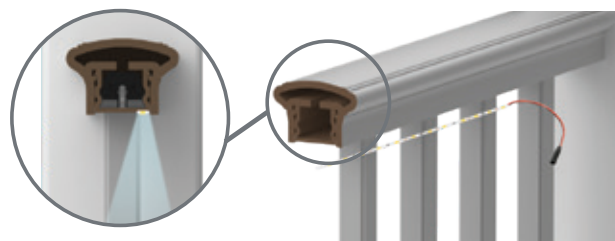

Extra Accessories	
Description	
Transform Brackets – Set of 4	73019126
Transform Baluster Plugs for 1 1/8" Square Balusters – Bag of 20	73019232
96" Aspire/Presence Top Rail IBC Stiffener – Box of 4*	73019002
96" Emerge Top Rail IBC Stiffener – Box of 4*	73019003
72" Transform Top Rail Adapter for mix and match with MetalWorks Excalibur® (2 and hardware)	73019235
96" Transform Top Rail Adapter for mix and match with MetalWorks Excalibur® (2 and hardware)	73019236

*For commercial railing heights of 42" with lengths over 91", the IBC Stiffener is required for code compliance.

Bella Premier Series



Bella Premier Series Composite Railing is made from Compositore® — a material that contains no wood or organic fibers — and provides superior resistance to moisture, mold and warping. It features a vinyl cap with a smooth, durable finish for long-lasting appeal. Bella Premier Series offers a deck board adapter that creates a flat “cocktail rail.” Brackets conceal fasteners for a clean finish and multiple infill styles are available.



Compositore®

Compositore used in our railing products, contains no wood fibers, making it water resistant meaning it will not rot, splinter, warp or stain and is resistant to mold — keeping your railing beautiful for years to come.

- Does not warp, splinter or rot — easy to maintain with long lasting color retention
- Innovative dovetail level rail brackets allow for easy assembly
- Bracket design hides unsightly fasteners to provide a clean, finished look
- Deck board adapter easily creates flat, “cocktail rail”
- Made in the USA with Transferable Limited Lifetime Warranty

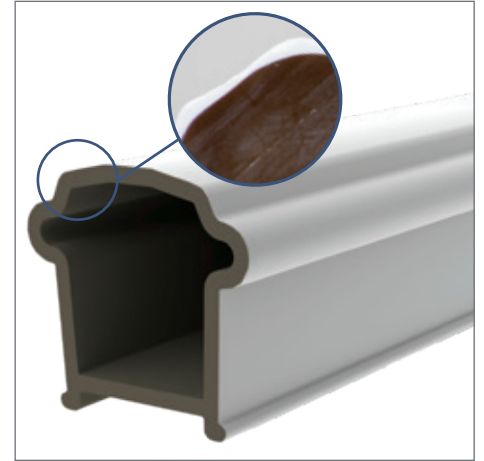

White



Clay



How to Shop:

Square and Black Round Aluminum Balusters

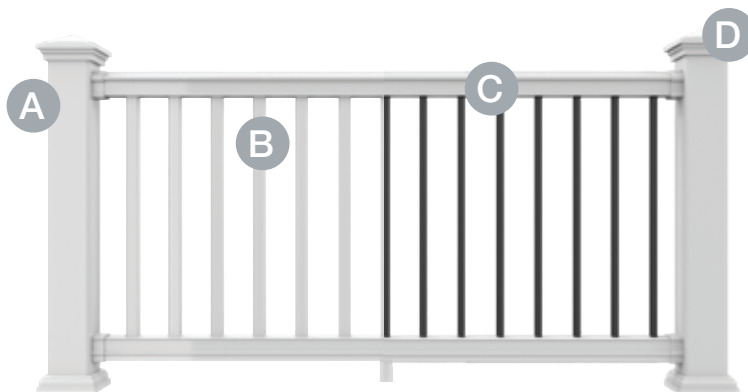

A Pick Your Posts

Post sleeves available for wooden 4" x 4" or structural posts.

B Pick Your Rail Kit

Includes top and bottom rails, balusters, support foot, brackets and mounting hardware.

C Create a Deck Top Rail

The Deck Board Top Adapter mounts easily to the top rail and allows for installation of a deck board (sold separately).

D Pick Your Accessories

Post accessories include post caps in both standard and LED styles and trim rings.

Structural Posts

Description	
Structural Post for 36" Rail Height – Flush Mount	73019022
Structural Post for 36" Rail Height – Thru/Fascia Mount	73019023
Structural Post for 42" Rail Height – Flush Mount	73019024
Structural Post for 42" Rail Height – Thru/Fascia Mount	73019025

Vinyl Post Sleeves & Post Wraps

Description	White	Clay
4" x 4" x 39" Post Sleeve (unit pack of 84)	61109087	73053601
4" x 4" x 39" Post Sleeve (unit pack of 22)	73019260	N/A
4" x 4" x 45" Post Sleeve	61109088	73053602
4" x 4" x 54" Post Sleeve	73019029	N/A
4" x 4" x 100" Post Sleeve	73012479	N/A
4" x 4" x 108" Post Sleeve	61109090	73053603
4" x 4" x 120" Post Sleeve	73006803	N/A
4" x 4" x 48" Turned Post Sleeve (requires structural post)	73056354	N/A
5" x 5" x 39" Post Sleeve	73043921	N/A
5" x 5" x 45" Post Sleeve	73043922	N/A
5" x 5" x 108" Post Sleeve	73043923	N/A
5" x 5" Post Inserts*	73019139	
6" x 6" x 54" Post Sleeve	73018734	N/A
6" x 6" x 108" Post Sleeve	73018731	73053608
6" x 6" x 144" Post Sleeve	73047640	N/A
4" x 4" x 96" – 4-Piece Post Wrap**	73018473	73053604
4" x 4" x 120" – 4-Piece Post Wrap**	73018007	73053605
6" x 6" x 96" – 4-Piece Post Wrap**	73018478	73053606
6" x 6" x 120" – 4-Piece Post Wrap**	73018008	73053607

*Post inserts are used when sleeving 4" x 4" wooden posts or structural posts.

**4" x 4" post wrap can wrap a post from 3³/₈" square to 4¹/₈" square and 6" x 6" post wrap can wrap a post from 5⁷/₁₆" square to 6¹/₈" square.

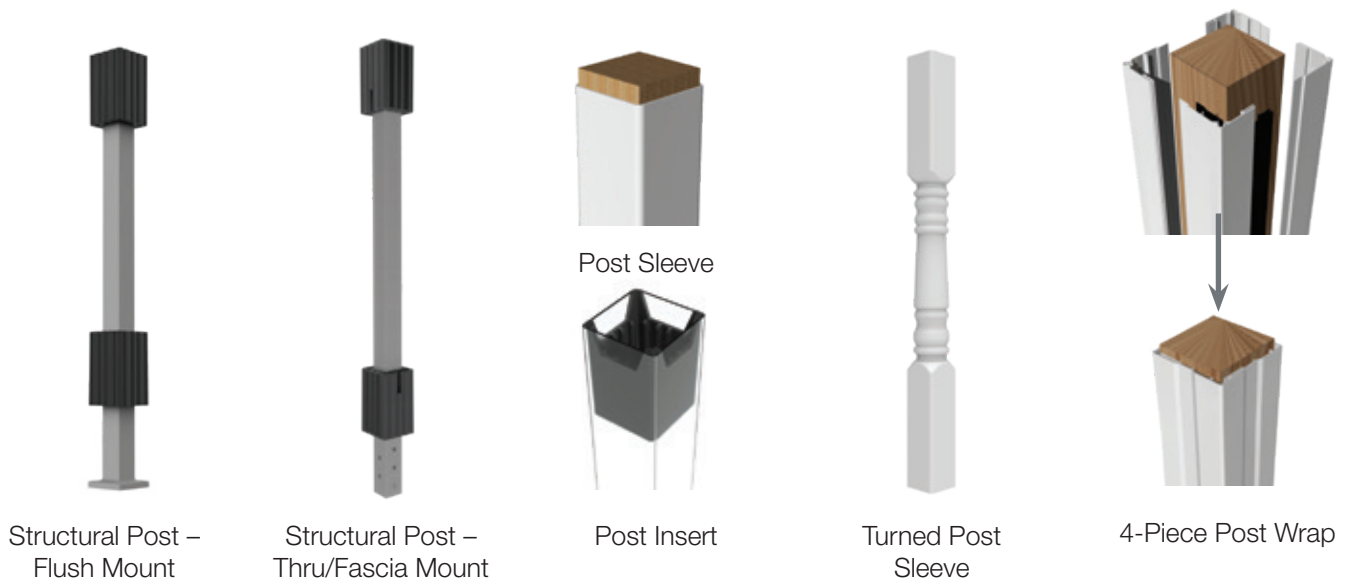

Bella Premier Series

Vinyl Porch Posts		
Description	White	Clay
4" x 4" x 108" Square Post – 2,500 lb. Capacity*	73056308	N/A
4" x 4" x 108" Turned Post – 2,500 lb. Capacity*	73056309	N/A
5" x 5" x 108" Square Post – 5,000 lb. Capacity*	73056351	N/A
5" x 5" x 108" Turned Post – 5,000 lb. Capacity*	73056310	73056352

*Porch posts include round aluminum support tube, decorative column, filler strips (turned) or mounting blocks (square) and 2 surface mounting plates.

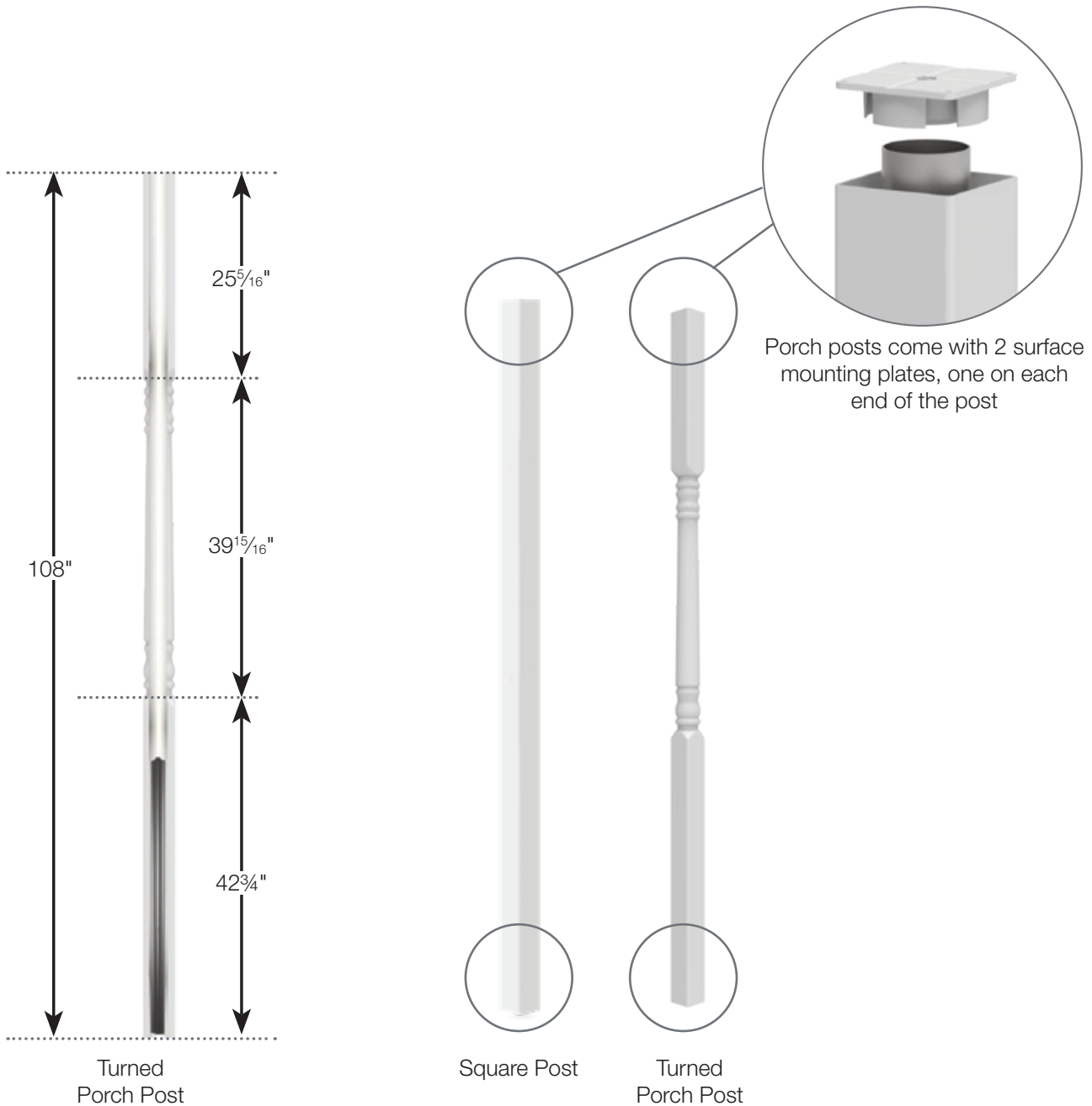

Vinyl Post Caps

Description	White	Clay
4" x 4" Flat Post Cap	73018076	73053668
4" x 4" New England Post Cap	73044950	73053673
4" x 4" Elite Post Cap	73018073	73018071
4" x 4" Heritage Post Cap	73012500	N/A
4" x 4" Contemporary Post Cap	73019233	N/A
4" x 4" Contemporary Solar Post Cap	73019234	73045510
5" x 5" Flat Post Cap	73003093	N/A
5" x 5" New England Post Cap	73045003	N/A
5" x 5" Contemporary Post Cap	73013124	N/A
5" x 5" Contemporary Solar Post Cap	73013110	N/A
6" x 6" New England Post Cap	73018108	73018106
6" x 6" Elite Post Cap	73018105	N/A

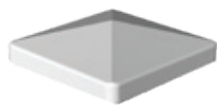

Flat Post Cap



New England Post Cap



4" Elite Post Cap



6" Elite Post Cap

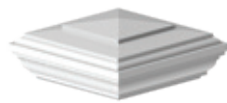

Heritage Post Cap



Contemporary Post Cap

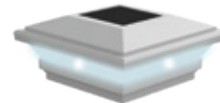

Contemporary Solar Post Cap

Vinyl Trim Rings

Description	White	Clay
4" x 4" Elite Trim Ring	73018091	73018092
4" x 4" Heritage Trim Ring*	73012503	73053674
4" x 4" Low Profile Trim Ring	73045041	73053680
5" x 5" 2-Piece Trim Ring	73043929	N/A
3.5" to 6.5" – 4-Piece Elite Trim Ring**	73018131	73018066
6" x 6" Low Profile Trim Ring	73055142	N/A

*The Heritage Trim Ring complements the New England Post Cap and the Heritage Post Cap.

**Adjustable Elite 4-Piece Trim Ring can be installed at any time and can be adjusted to fit posts from 3½" x 3½" to 6½" x 6½" without nails, screws or glue.



Elite Trim Ring

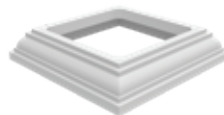

Heritage Trim Ring



Low Profile Trim Ring



5" 2-Piece Trim Ring



4-Piece Elite Trim Ring

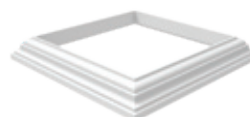

6" Low Profile Trim Ring

Square Baluster Kits		
Description	White	Clay
6' x 36" Rail Kit with Square Balusters	73012442	73053658
8' x 36" Rail Kit with Square Balusters	73012448	73053660
10' x 36" Rail Kit with Square Balusters	73013195	73053662
6' x 36" Stair Kit with Square Balusters	73053495	73053503
8' x 36" Stair Kit with Square Balusters	73053498	73053505
6' x 42" Rail Kit with Square Balusters	73012454	N/A
8' x 42" Rail Kit with Square Balusters	73012456	N/A
6' x 42" Stair Kit with Square Balusters	73053501	N/A
8' x 42" Stair Kit with Square Balusters	73053502	N/A

Level rail kits include top and bottom rails, brackets, balusters and support feet.
 8' and 10' kits include top rail aluminum stiffener.
 Stair rail kits include top and bottom rails, brackets and balusters.

3/4" Black Round Aluminum Baluster Kits		
Description	White	Clay
6' x 36" Rail Kit with 3/4" Black Round Aluminum Balusters	73012446	73053659
8' x 36" Rail Kit with 3/4" Black Round Aluminum Balusters	73012452	73053661
10' x 36" Rail Kit with 3/4" Black Round Aluminum Balusters	73013178	73053663
6' x 36" Stair Kit with 3/4" Black Round Aluminum Balusters	73053497	73053504
8' x 36" Stair Kit with 3/4" Black Round Aluminum Balusters	73053500	73053506

Level rail kits include top and bottom rails, brackets, balusters and support feet.
 8' and 10' kits include top rail aluminum stiffener.

Stair rail kits include top and bottom rails, brackets and balusters.

6' length rails (67¹/₈" actual size)
 8' length rails (91¹/₈" actual size)
 10' length rails (115¹/₈" actual size)
 6' length stairs (67¹/₈" actual size)
 8' length stairs (91¹/₈" actual size)
 36" & 42" finished heights (with 3"
 bottom space)



1¹/₈" Square Balusters



3/4" Black Round Aluminum Balusters

Brackets and Bracket Adapter		
Description	White	Clay
Level Bracket – 4 Pc. (2 top and 2 bottom brackets)	73012494	73053682
Stair Bracket – 4 Pc. (non-adjustable – 2 top and 2 bottom brackets)	73053493	73053494
Angle Bracket – 4 Pc. (adjustable to a level angle of 45° – 2 top and 2 bottom brackets)	73012498	73053684
4 ¹ / ₂ " Paintable Round Column Adapters (2 pieces for 8" columns)	73019453	N/A

Deck Board Top Adapter

Description	White	Clay
8' Deck Board Adapter (2 pack)	73028079	73053685

Deck board top adapters include top rail and top bracket adapters and hardware.
Deck board adapter fits on top of the top rail creating a flat mounting surface for your deck board.



Vinyl Rail Gate Kits

Description	White	Clay
Standard Width Gate Kit – 36" H – 1¼" Square Balusters	73018135	N/A
Custom Width Gate Kit – 36" H – 1¼" Square Balusters	73045025	N/A
Custom Width Gate Kit – 36" H – 1½" Square Balusters	73045028	73053676
Custom Width Gate Kit – 36" H – ¾" Round Aluminum Balusters	73045031	73053677
Custom Width Gate Kit – 42" H – 1¼" Square Balusters	73045035	N/A
Custom Width Gate Kit – 42" H – 1½" Square Balusters	73045038	73053679

Standard gate kit has a maximum opening width of 36". Custom gate kits have a maximum width opening up to 48". Gate kits include everything to build a gate panel.
Gate hardware sold separately.



Standard Gate Kit



Custom Gate Kit

Gate Hardware

Description	Black	White
Standard Wrap Hinge Pair	73028117	73025512
Two-Sided Locking Latch	73050187	73050188
Gravity Latch	73002252	73025491



Finyl Line Vinyl Railing is easy to install and is reinforced with strong aluminum — designed to provide added safety. Choose from a traditional T-Top style or Deck Top profile to add a deck board to and create a flat "cocktail rail". Available with three baluster styles — square, turned or black round aluminum and a Decorative Screen Panel* infill option.

**Decorative Screen Panels sold separately.*

- Decorative Screen Panel infill option offers increased customization
- Deck Top rail allows for deck board to be easily turned into a flat "cocktail rail"
- Brackets conceal all fasteners — providing a clean, finished look
- Made in the USA with Transferable Limited Lifetime Warranty



White



Clay



Sand



How to Shop:

Square or Turned Balusters

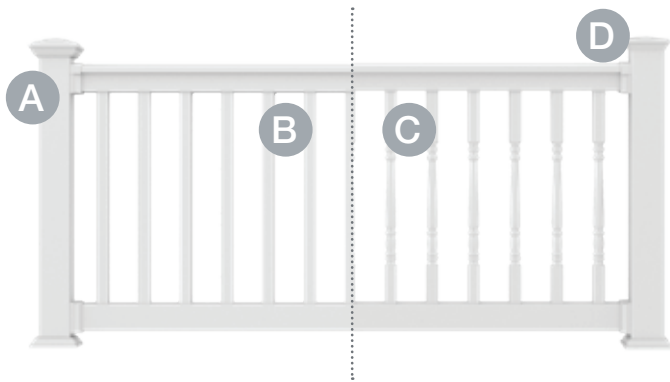

A Pick Your Posts

Post sleeves available for wooden 4" x 4" or structural posts.

B Pick Your Rail Kit – Square Balusters

Includes top and bottom rails with aluminum stiffeners, balusters, brackets and mounting hardware; T-Top or Deck Top (requires deck board – sold separately) profiles available.

C Pick Your Rail Kit – Turned Balusters

Includes top and bottom rails with aluminum stiffeners, balusters, brackets and mounting hardware. T-Top profile only.

D Pick Your Accessories

Post accessories include post caps in both standard and LED styles and trim rings.

Black Round Aluminum Balusters

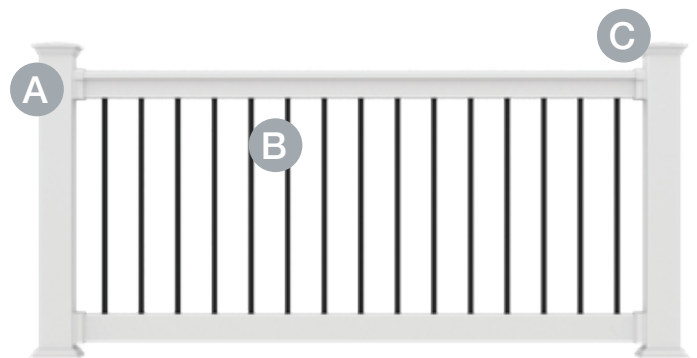

A Pick Your Posts

Post sleeves available for wooden 4" x 4" or structural posts.

B Pick Your Rail Kit

Includes top and bottom rails with aluminum stiffeners, balusters, brackets and mounting hardware; T-Top or Deck Top (requires deck board – sold separately) profiles available.

C Pick Your Accessories

Post accessories include post caps in both standard and LED styles and trim rings.

T-Top with Decorative Infill
(Level Only)

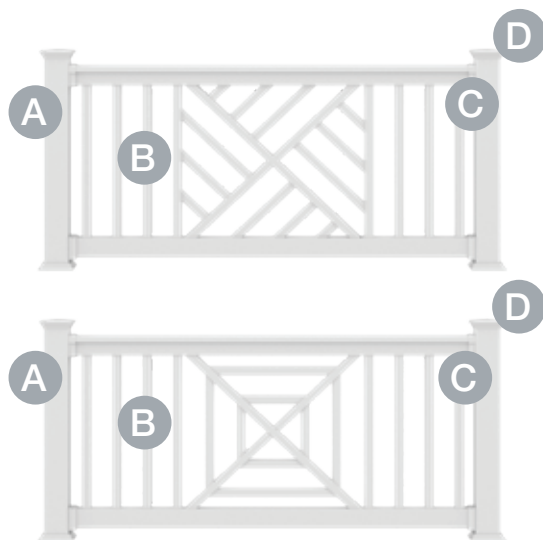

A Pick Your Posts

Post sleeves available for wooden 4" x 4" or structural posts.

B Pick Your Rail Kit

Pre-assembled rail panel comes in two decorative infill styles.

C Pick Your Brackets

Level and level angle brackets are sold separately.

D Pick Your Accessories

Post accessories include post caps in both standard and LED styles and trim rings.

T-Top with Decorative Screen Panel Infill
(Level Only)

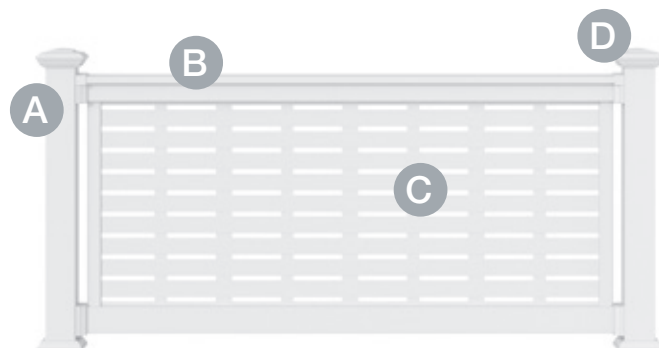

A Pick Your Posts

Post sleeves available for wooden 4" x 4" or structural posts.

B Pick Your Rail Kit

Includes top and bottom rails with aluminum stiffeners, brackets, mounting hardware and Decorative Screen Panel uprights. For 36" finished rail heights only.

C Pick Your Infill

3' x 6' Decorative Screen Panel infill – available in 4 styles and a variety of color combinations (sold separately).

D Pick Your Accessories

Post accessories include post caps in both standard and LED styles and trim rings.

Structural Posts	
Description	
Structural Post for 36" Rail Height – Flush Mount	73019022
Structural Post for 36" Rail Height – Thru/Fascia Mount	73019023
Structural Post for 42" Rail Height – Flush Mount	73019024
Structural Post for 42" Rail Height – Thru/Fascia Mount	73019025

Vinyl Post Sleeves & Post Wraps			
Description	White	Clay	Sand
4" x 4" x 39" Post Sleeve (unit pack of 84)	61109087	73053601	73041475
4" x 4" x 39" Post Sleeve (unit pack of 22)	73019260	N/A	N/A
4" x 4" x 45" Post Sleeve	61109088	73053602	73041476
4" x 4" x 54" Post Sleeve	73019029	N/A	N/A
4" x 4" x 100" Post Sleeve	73012479	N/A	N/A
4" x 4" x 108" Post Sleeve	61109090	73053603	73041477
4" x 4" x 120" Post Sleeve	73006803	N/A	N/A
4" x 4" x 48" Turned Post Sleeve (requires structural post)	73056354	N/A	N/A
5" x 5" x 39" Post Sleeve	73043921	N/A	N/A
5" x 5" x 45" Post Sleeve	73043922	N/A	N/A
5" x 5" x 108" Post Sleeve	73043923	N/A	N/A
5" x 5" Post Inserts*	73019139		
6" x 6" x 54" Post Sleeve	73018734	N/A	N/A
6" x 6" x 108" Post Sleeve	73018731	73053608	73041478
6" x 6" x 144" Post Sleeve	73047640	N/A	N/A
4" x 4" x 96" – 4-Piece Post Wrap**	73018473	73053604	73041479
4" x 4" x 120" – 4-Piece Post Wrap**	73018007	73053605	73041480
6" x 6" x 96" – 4-Piece Post Wrap**	73018478	73053606	73041481
6" x 6" x 120" – 4-Piece Post Wrap**	73018008	73053607	73041482

*Post inserts are used when sleeving 4" x 4" wooden posts or structural posts.

**4" x 4" post wrap can wrap a post from 3³/₈" square to 4¹/₈" square and 6" x 6" post wrap can wrap a post from 5⁷/₁₆" square to 6¹/₈" square.

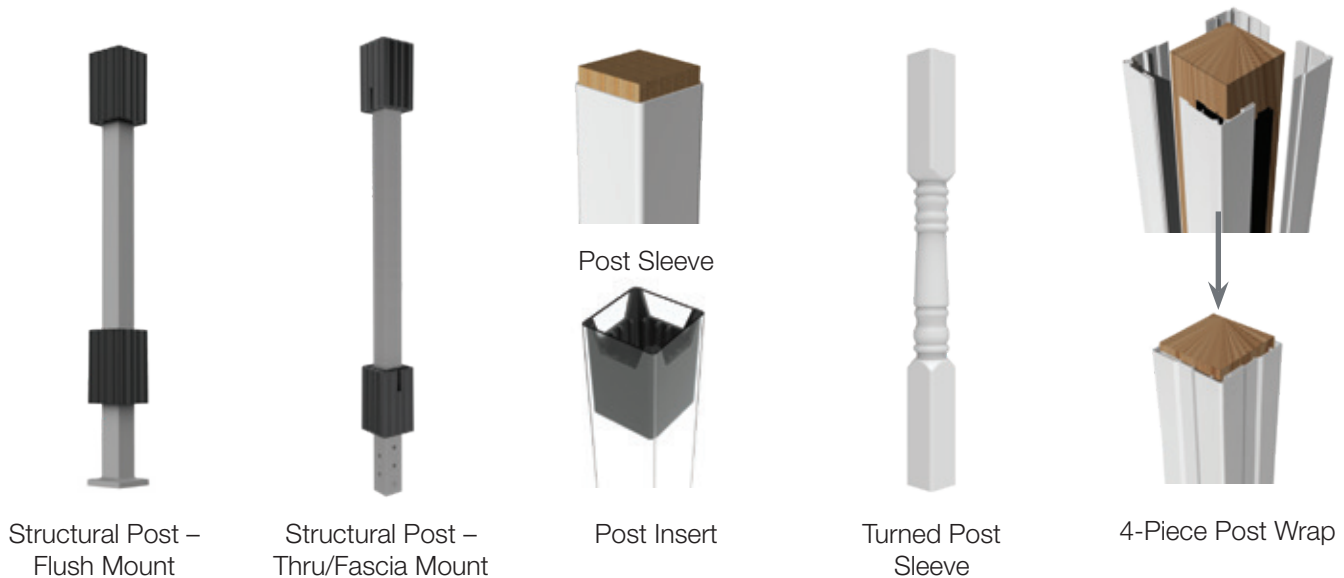

Vinyl Porch Posts			
Description	White	Clay	Sand
4" x 4" x 108" Square Post – 2,500 lb. Capacity*	73056308	N/A	N/A
4" x 4" x 108" Turned Post – 2,500 lb. Capacity*	73056309	N/A	N/A
5" x 5" x 108" Square Post – 5,000 lb. Capacity*	73056351	N/A	N/A
5" x 5" x 108" Turned Post – 5,000 lb. Capacity*	73056310	73056352	73056353

*Porch posts include round aluminum support tube, decorative column, filler strips (turned) or mounting blocks (square) and 2 surface mounting plates.

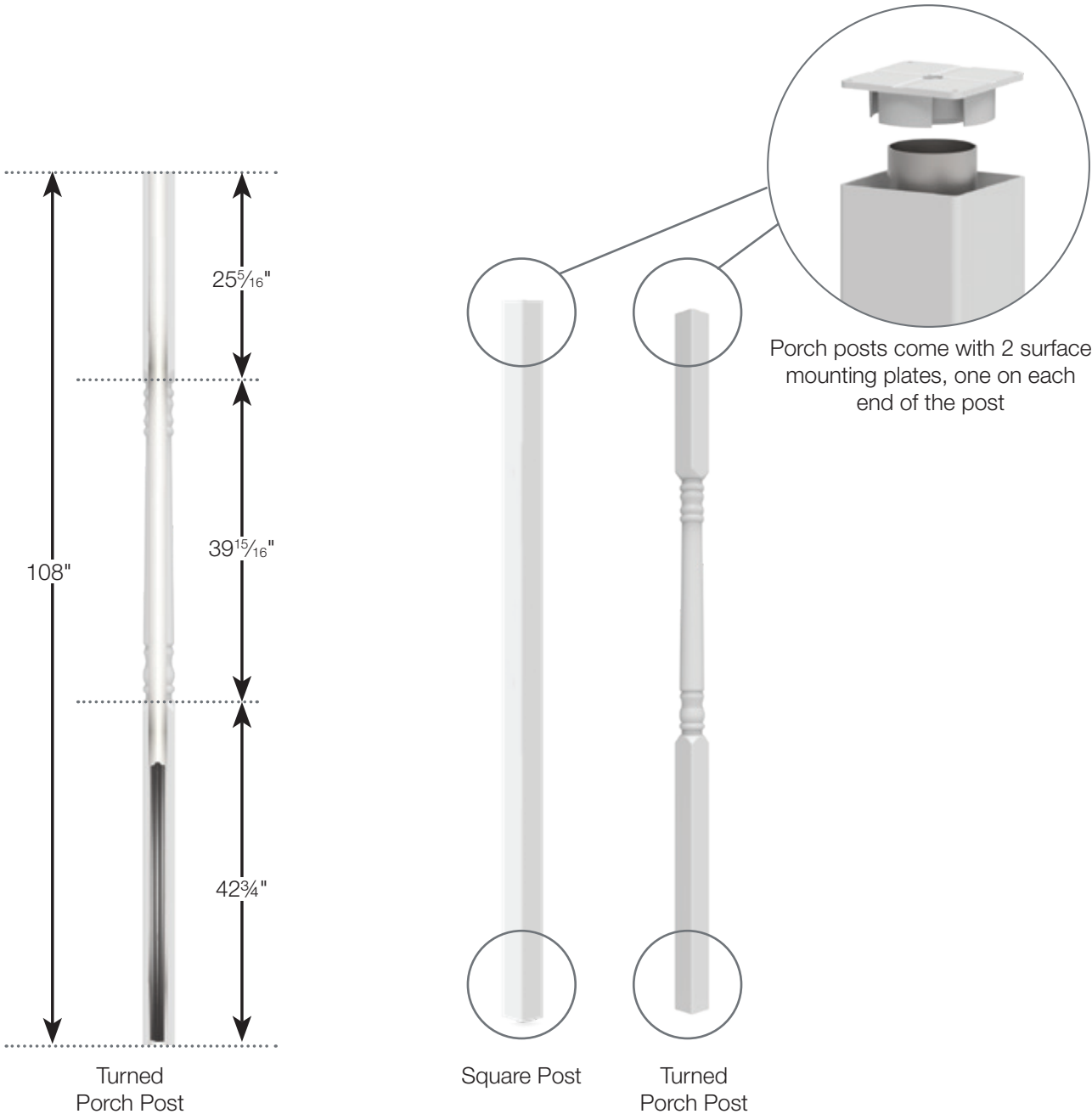

Vinyl Post Caps			
Description	White	Clay	Sand
4" x 4" Flat Post Cap	73018076	73053668	73041484
4" x 4" New England Post Cap	73044950	73053673	73044952
4" x 4" Elite Post Cap	73018073	73018071	73041485
4" x 4" Heritage Post Cap	73012500	N/A	N/A
4" x 4" Contemporary Post Cap	73019233	N/A	N/A
4" x 4" Contemporary Solar Post Cap	73019234	73045510	73045511
5" x 5" Flat Post Cap	73003093	N/A	N/A
5" x 5" New England Post Cap	73045003	N/A	N/A
5" x 5" Contemporary Post Cap	73013124	N/A	N/A
5" x 5" Contemporary Solar Post Cap	73013110	N/A	N/A
6" x 6" New England Post Cap	73018108	73018106	73041489
6" x 6" Elite Post Cap	73018105	N/A	N/A

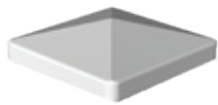

Flat Post Cap



New England Post Cap



4" Elite Post Cap



6" Elite Post Cap

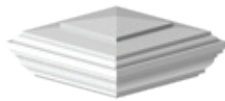

Heritage Post Cap



Contemporary Post Cap

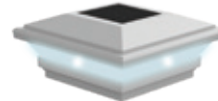

Contemporary Solar Post Cap

Vinyl Trim Rings			
Description	White	Clay	Sand
4" x 4" Elite Trim Ring	73018091	73018092	73041490
4" x 4" Heritage Trim Ring*	73012503	73053674	73045024
4" x 4" Low Profile Trim Ring	73045041	73053680	73045043
5" x 5" 2-Piece Trim Ring	73043929	N/A	N/A
3.5" to 6.5" – 4-Piece Elite Trim Ring**	73018131	73018066	73041493
6" x 6" Low Profile Trim Ring	73055142	N/A	N/A

*The Heritage Trim Ring complements the New England Post Cap and the Heritage Post Cap.

**Adjustable Elite 4–Piece Trim Ring can be installed at any time and can be adjusted to fit posts from 3½" x 3½" to 6½" x 6½" without nails, screws or glue.



Elite Trim Ring

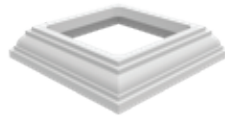

Heritage Trim Ring



Low Profile Trim Ring



5" 2-Piece Trim Ring



4-Piece Elite Trim Ring

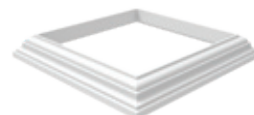

6" Low Profile Trim Ring

T-Top 1½" Square Baluster Rail Kits – 36" Height

Description	White	White*	Clay	Sand
4' x 36" H – Level Rail Kit	73019536	N/A	N/A	N/A
5' x 36" H – Level Rail Kit	73019560	N/A	73055456	N/A
6' x 36" H – Level Rail Kit	73019603	73019690	73053637	73041503
8' x 36" H – Level Rail Kit	73019652	73019691	73053649	73041563
10' x 36" H – Level Rail Kit	73019517	73019687	73053631	73041504
6' x 36" H – 26 Degree to 38 Degree Stair Rail Kit	73019599	73019600	73053639	73041505
8' x 36" H – 26 Degree to 38 Degree Stair Rail Kit	73019648	73019649	73053652	73041506
10' x 36" H – 26 Degree to 38 Degree Stair Rail Kit	73019515	N/A	N/A	N/A

*Packed in clear see-through shrink "toughpack"; all other kits boxed.

Kits include top and bottom rails with aluminum stiffeners, balusters, bracket kit, support foot (10' kits only) and installation hardware.

T-Top 1½" Square Baluster Rail Kits – 42" Height

Description	White	Clay	Sand
4' x 42" H – Level Rail Kit	73019543	N/A	N/A
5' x 42" H – Level Rail Kit	73019567	N/A	N/A
6' x 42" H – Level Rail Kit	73019616	73053641	73041509
8' x 42" H – Level Rail Kit	73019665	73053656	73041510
6' x 42" H – 26 Degree to 38 Degree Stair Rail Kit	73019615	N/A	N/A
8' x 42" H – 26 Degree to 38 Degree Stair Rail Kit	73019664	73053657	73041512

Kits include top and bottom rails with aluminum stiffeners, balusters, bracket kit, support foot and installation hardware.

T-Top 1½" Turned Baluster Rail Kits– 36" Height

Description	White	Clay
6' x 36" H – Level Rail Kit	73019604	73053638
8' x 36" H – Level Rail Kit	73019653	73053650
10' x 36" H – Level Rail Kit	73019519	73053632
6' x 36" H – 26 Degree to 38 Degree Stair Rail Kit	73019601	N/A
8' x 36" H – 26 Degree to 38 Degree Stair Rail Kit	73019650	73053653

Kits include top and bottom rails with aluminum stiffeners, balusters, bracket kit, support foot (10' kits only) and installation hardware.



1½" Square Balusters



1½" Turned Balusters



¾" Round Aluminum Balusters

T-Top 3/4" Round Aluminum Baluster Rail Kits – 36" Heights			
Description	White	Clay	Sand
4' x 36" H – Level Rail Kit	73019535	N/A	N/A
5' x 36" H – Level Rail Kit	73055261	73055457	N/A
6' x 36" H – Level Rail Kit	73019602	73053636	73041522
8' x 36" H – Level Rail Kit	73019651	73053648	73041523
10' x 36" H – Level Rail Kit	73019516	73053630	73041524
6' x 36" H – 26 Degree to 38 Degree Stair Rail Kit	73019598	N/A	N/A
8' x 36" H – 26 Degree to 38 Degree Stair Rail Kit	73019647	73053651	73041526

Kits include top and bottom rails with aluminum stiffeners, balusters, bracket kit, support foot (10' kits only) and installation hardware.

T-Top 3/4" Round Aluminum Baluster Rail Kits – 42" Heights	
Description	White
5' x 42" H – Level Rail Kit	73055458
6' x 42" H – Level Rail Kit	73055459
8' x 42" H – Level Rail Kit	73055460
6' x 42" H – 26 Degree to 38 Degree Stair Rail Kit	73055471
8' x 42" H – 26 Degree to 38 Degree Stair Rail Kit	73055472

T-Top Decorative Infill Pre-Built Panels – 36" Height	
Description	White
6' x 36" H – Chippendale Level Rail Panel	73047634
8' x 36" H – Chippendale Level Rail Panel	73047635
10' x 36" H – Chippendale Level Rail Panel	73047636
6' x 36" H – Freeport Level Rail Panel	73047637
8' x 36" H – Freeport Level Rail Panel	73047638
10' x 36" H – Freeport Level Rail Panel	73047639

Decorative infill SKUs come as pre-built panels. Brackets not included with rail panels; must be purchased separately.

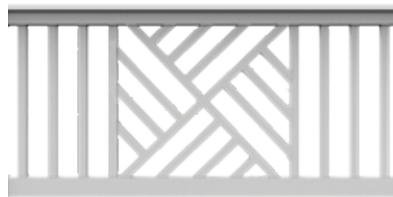

Chippendale

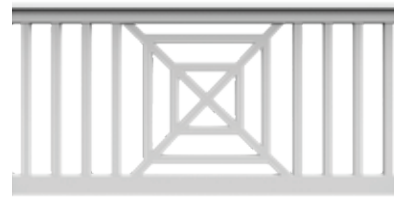

Freeport

T-Top Level Rail Kit for 3' x 6' Decorative Screen Panel Infill			
Description	White	Clay	Sand
6' x 36" H – Level Rail Kit for Decorative Screen Panels (sold separately)	73050461	73054371	73050463

Kit includes top and bottom rails with aluminum stiffeners, 2 uprights, bracket kit and installation hardware.



Level Rail Kit with Decorative Screen Panel infill (sold separately)

3' x 6' Decorative Screen Panels

Description	Boardwalk	Sanibel	River Rock	Optic
3' x 6' x 0.3" – White	73045664	N/A	N/A	N/A
3' x 6' x 0.3" – Gray	73045665	N/A	N/A	N/A
3' x 6' x 0.3" – Black	73030561	73050460	73045667	73050083

Actual size: 34" x 68" x 0.3".



Boardwalk



Sanibel
Design Patent Pending

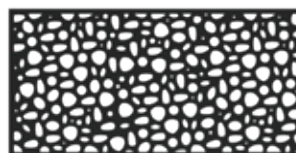

River Rock

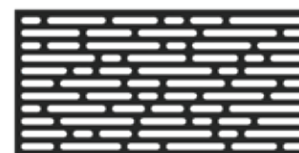

Optic

Decorative Screen Panels are designed with a matte, textured finish to allow them to be painted for complete customization.

Deck Top 1½" Square Baluster Rail Kits – 36" Height

Description	White	Clay	Sand
6' x 36" H – Level Rail Kit	73019584	73053634	73041529
8' x 36" H – Level Rail Kit	73019633	73053643	73041530
10' x 36" H – Level Rail Kit	73019518	N/A	N/A
6' x 36" H – 26 Degree to 38 Degree Stair Rail Kit	73019581	N/A	N/A
8' x 36" H – 26 Degree to 38 Degree Stair Rail Kit	73019630	73053646	73041533

Kits include top and bottom rails with aluminum stiffeners, balusters, bracket kit, support foot (10' kits only) and installation hardware.

Deck Top 1½" Square Baluster Rail Kits – 42" Height

Description	White	Clay	Sand
6' x 42" H – Level Rail Kit	73019610	N/A	N/A
8' x 42" H – Level Rail Kit	73019659	N/A	N/A
8' x 42" H – 26 Degree to 38 Degree Stair Rail Kit	73019658	N/A	N/A

Kits include top and bottom rails with aluminum stiffeners, balusters, bracket kit and installation hardware.

Deck Top ¾" Round Aluminum Baluster Rail Kits – 36" Height

Description	White	Clay	Sand
6' x 36" H – Level Rail Kit	73019583	73053633	73041549
8' x 36" H – Level Rail Kit	73019632	73053642	73041550
10' x 36" H – Level Rail Kit	73019507	N/A	N/A
6' x 36" H – 26 Degree to 38 Degree Stair Rail Kit	73019580	N/A	N/A
8' x 36" H – 26 Degree to 38 Degree Stair Rail Kit	73019629	73053645	73041553

Kits include top and bottom rails with aluminum stiffeners, balusters, bracket kit, support foot (10' kits only) and installation hardware.

T-Top Bracket Kits			
Description	White	Clay	Sand
Level Bracket Set (2 top and 2 bottom brackets)	73019685	73019681	73041560
Stair Bracket Set (2 top and 2 bottom brackets)	73019686	73019682	73041561
Swivel Stair Bracket Set (2 top and 2 bottom brackets)	73018804	N/A	N/A
Swivel Level-Angle Bracket Set (2 top and 2 bottom brackets)	73018805	N/A	N/A
Angle Bracket Set (1 pair – cut to desired angle)	73021923	73021924	73041562



T-Top Level Brackets



T-Top Stair Brackets
(26 Degrees to 38 Degrees)



T-Top Swivel Stair Brackets
(0 Degrees to 45 Degrees)



T-Top Swivel Level-Angle Brackets
(0 Degrees to 44 Degrees)



T-Top Angle Brackets

Deck Top Bracket Kits			
Description	White	Clay	Sand
Level Bracket Set (2 top and 2 bottom brackets)	73019670	73019666	73041554
Stair Bracket Set (2 top and 2 bottom brackets)	73019671	73019667	73041555
Angle Bracket Set (1 pair – cut to desired angle)	73021926	73021927	73041556



Deck Top Level Brackets



Deck Top Stair Brackets
(26 Degrees to 38 Degrees)



Deck Top Angle Brackets

Column and Angle Adapters			
Description	White	Clay	Sand
8" Round Column Adapter (2 pack)	73019680	73019674	73041557
22.5 Degree Angle Adapter (1 top and 1 bottom brackets)	73019678	73019672	73041559
45 Degree Angle Adapter (1 top and 1 bottom brackets)	73019679	73019673	73041558



Round Column Adapter
for 8" Columns



22.5 Degree
Adapter



45 Degree
Adapter

Vinyl Rail Gate Kits			
Description	White	Clay	Sand
Standard Width Gate Kit – 36" H – 1¼" Square Balusters	73018135	N/A	N/A
Custom Width Gate Kit – 36" H – 1¼" Square Balusters	73045025	N/A	N/A
Custom Width Gate Kit – 36" H – 1½" Square Balusters	73045028	73053676	73045030
Custom Width Gate Kit – 36" H – 1¼" Turned Balusters	73045034	N/A	N/A
Custom Width Gate Kit – 36" H – 1½" Turned Balusters	73045044	73053681	73045046
Custom Width Gate Kit – 36" H – ¾" Round Aluminum Balusters	73045031	73053677	73045033
Custom Width Gate Kit – 42" H – 1¼" Square Balusters	73045035	N/A	N/A
Custom Width Gate Kit – 42" H – 1½" Square Balusters	73045038	73053679	73045040

Standard gate kit has a maximum opening width of 36". Custom gate kits have a maximum width opening up to 48". Gate kits include everything to build a gate panel. Gate hardware sold separately.



Standard Gate Kit



Custom Gate Kit

Vinyl Gate Hardware		
Description	Black	White
Standard Wrap Hinge Pair	73028117	73025512
Two-Sided Locking Latch	73050187	73050188
Gravity Latch	73002252	73025491
24" Heavy-Duty Drop Rod	73014305	73014306

LED lighting options are available for use with Finyl Line. For details and options, see page 80.

Endurance® Original Rail™



Endurance Original Rail is a full vinyl railing system with everything needed to build a railing in one box. Endurance Original Rail offers dependable function with rails that are reinforced with aluminum stiffeners for added strength. A wide range of brackets are also available to meet a variety of installation needs.

- 4 infill options — including round aluminum balusters and glass slats
- Hidden fasteners provide a clean, finished look
- Aluminum stiffeners reinforce top and bottom rails for added strength and support
- Made in the USA with Transferable Limited Lifetime Warranty



White



Clay



How to Shop:

Square Balusters

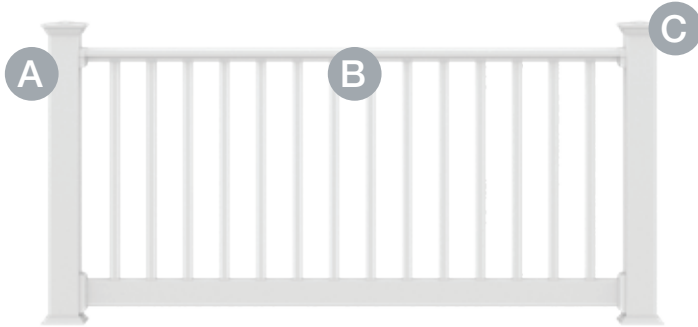

A Pick Your Posts

Post sleeves available for wooden 4" x 4" or structural posts.

B Pick Your Rail Kit

Includes top and bottom rails with aluminum stiffeners, balusters, brackets and mounting hardware.

C Pick Your Accessories

Post accessories include post caps in both standard and LED styles and trim rings.

Black Round Aluminum Balusters

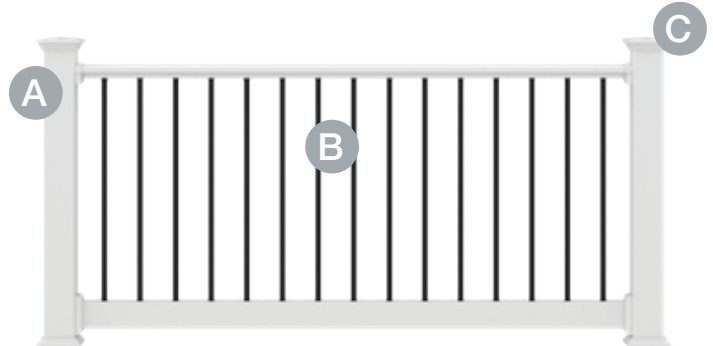

A Pick Your Posts

Post sleeves available for wooden 4" x 4" or structural posts.

B Pick Your Rail Kit

Includes top and bottom rails with aluminum stiffeners, balusters, brackets and mounting hardware.

C Pick Your Accessories

Post accessories include post caps in both standard and LED styles and trim rings.

Turned Balusters

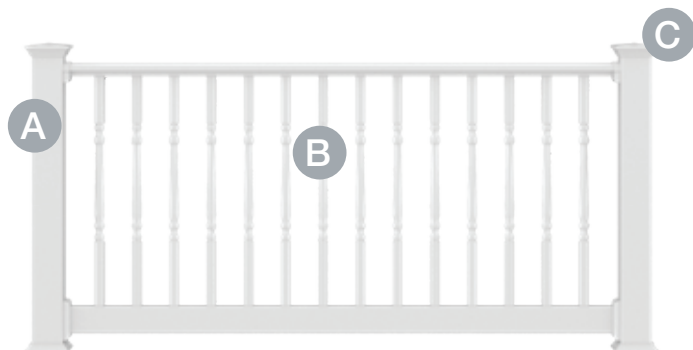

A Pick Your Posts

Post sleeves available for wooden 4" x 4" or structural posts.

B Pick Your Rail Kit

Includes top and bottom rails with aluminum stiffeners, balusters, brackets and mounting hardware.

C Pick Your Accessories

Post accessories include post caps in both standard and LED styles and trim rings.

Glass Slats (Level Only)

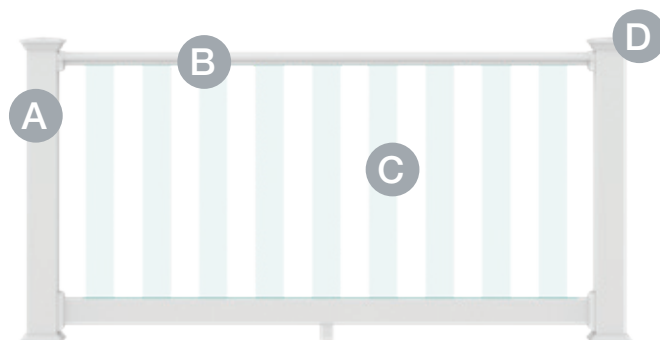

A Pick Your Posts

Post sleeves available for wooden 4" x 4" or structural posts.

B Pick Your Beam Kit

Includes top and bottom rails with aluminum stiffeners, brackets and mounting hardware.

C Pick Your Infill

Glass slats sold separately for 36" and 42" level sections only.

D Pick Your Accessories

Post accessories include post caps in both standard and LED styles and trim rings.

Structural Posts	
Description	
Structural Post for 36" Rail Height – Flush Mount	73019022
Structural Post for 36" Rail Height – Thru/Fascia Mount	73019023
Structural Post for 42" Rail Height – Flush Mount	73019024
Structural Post for 42" Rail Height – Thru/Fascia Mount	73019025

Vinyl Post Sleeves & Post Wraps		
Description	White	Clay
4" x 4" x 39" Post Sleeve (unit pack of 84)	61109087	73053601
4" x 4" x 39" Post Sleeve (unit pack of 22)	73019260	N/A
4" x 4" x 45" Post Sleeve	61109088	73053602
4" x 4" x 54" Post Sleeve	73019029	N/A
4" x 4" x 100" Post Sleeve	73012479	N/A
4" x 4" x 108" Post Sleeve	61109090	73053603
4" x 4" x 120" Post Sleeve	73006803	N/A
4" x 4" x 48" Turned Post Sleeve (requires structural post)	73056354	N/A
5" x 5" x 39" Post Sleeve	73043921	N/A
5" x 5" x 45" Post Sleeve	73043922	N/A
5" x 5" x 108" Post Sleeve	73043923	N/A
5" x 5" Post Inserts*	73019139	
6" x 6" x 54" Post Sleeve	73018734	N/A
6" x 6" x 108" Post Sleeve	73018731	73053608
6" x 6" x 144" Post Sleeve	73047640	N/A
4" x 4" x 96" – 4-Piece Post Wrap**	73018473	73053604
4" x 4" x 120" – 4-Piece Post Wrap**	73018007	73053605
6" x 6" x 96" – 4-Piece Post Wrap**	73018478	73053606
6" x 6" x 120" – 4-Piece Post Wrap**	73018008	73053607

*Post inserts are used when sleeving 4" x 4" wooden posts or structural posts.

**4" x 4" post wrap can wrap a post from 3³/₈" square to 4¹/₈" square and 6" x 6" post wrap can wrap a post from 5⁷/₁₆" square to 6¹/₈" square.

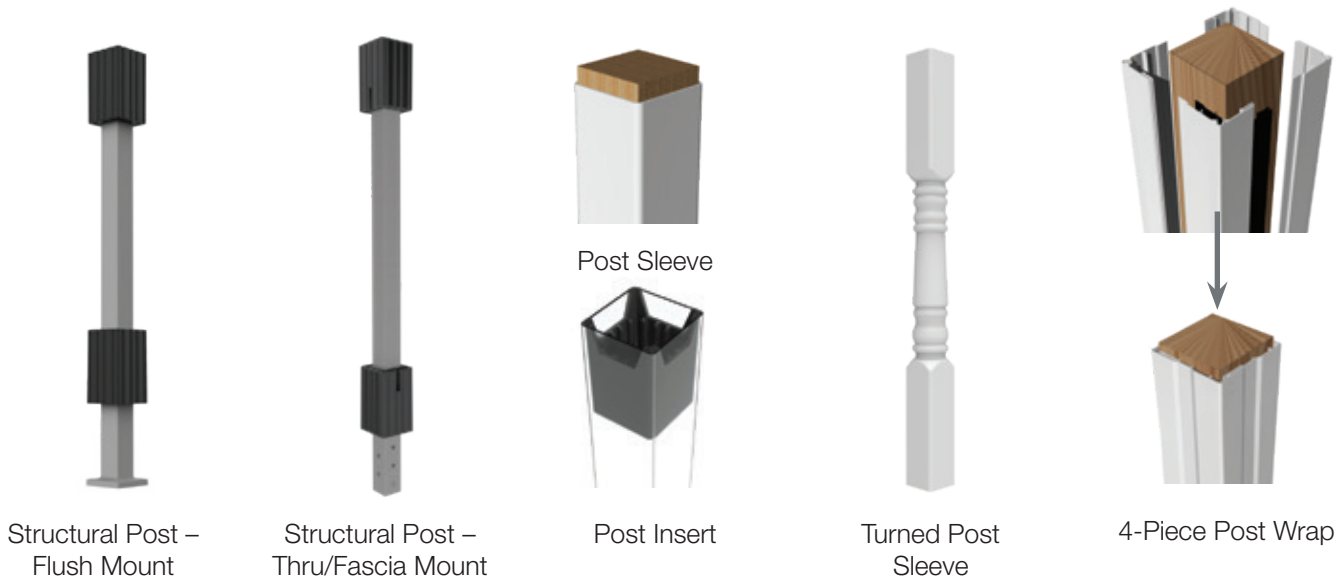

Vinyl Porch Posts		
Description	White	Clay
4" x 4" x 108" Square Post – 2,500 lb. Capacity*	73056308	N/A
4" x 4" x 108" Turned Post – 2,500 lb. Capacity*	73056309	N/A
5" x 5" x 108" Square Post – 5,000 lb. Capacity*	73056351	N/A
5" x 5" x 108" Turned Post – 5,000 lb. Capacity*	73056310	73056352

*Porch posts include round aluminum support tube, decorative column, filler strips (turned) or mounting blocks (square) and 2 surface mounting plates.

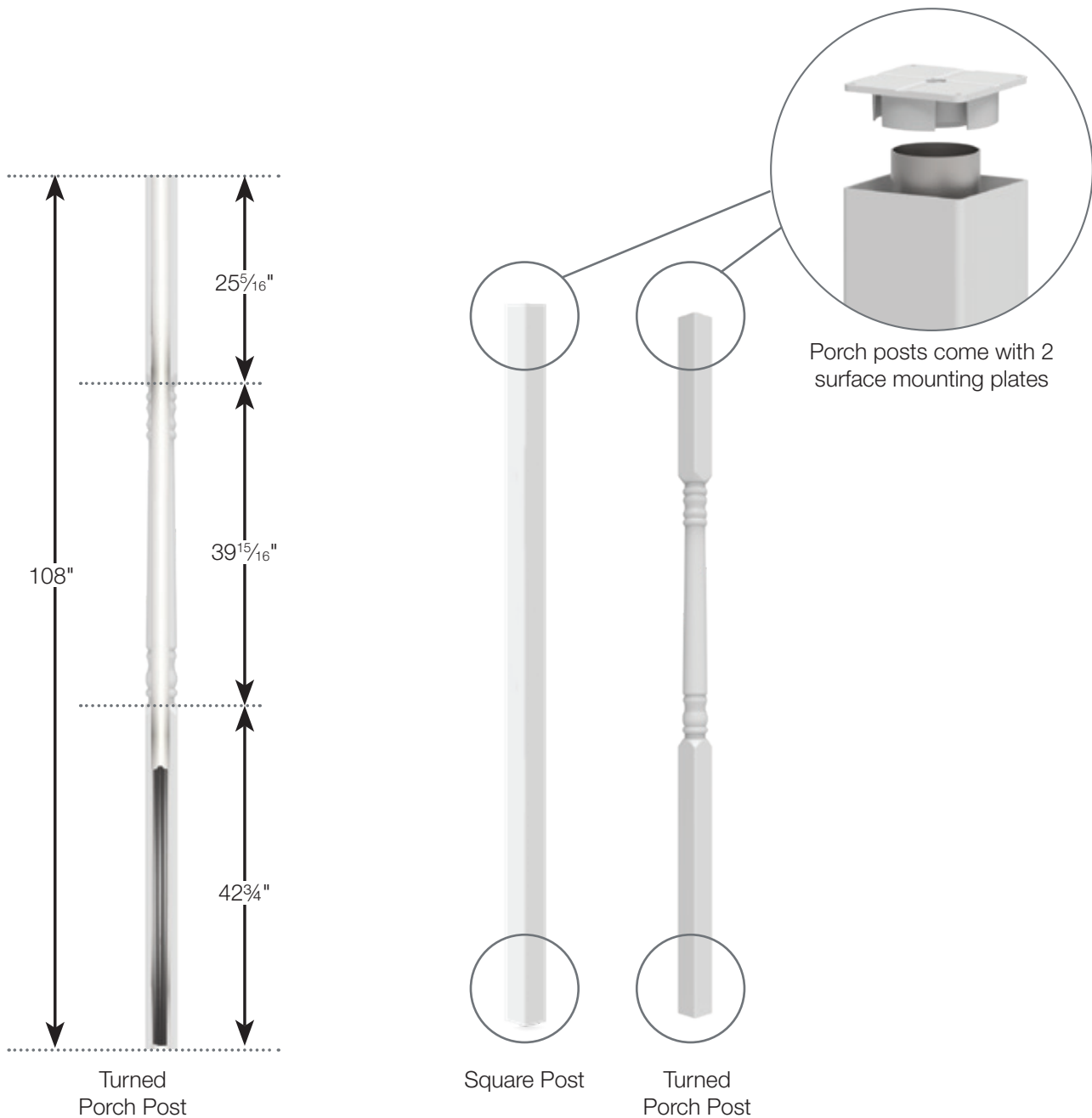

Vinyl Post Caps		
Description	White	Clay
4" x 4" Flat Post Cap	73018076	73053668
4" x 4" New England Post Cap	73044950	73053673
4" x 4" Elite Post Cap	73018073	73018071
4" x 4" Heritage Post Cap	73012500	N/A
4" x 4" Contemporary Post Cap	73019233	N/A
4" x 4" Contemporary Solar Post Cap	73019234	73045510
5" x 5" Flat Post Cap	73003093	N/A
5" x 5" New England Post Cap	73045003	N/A
5" x 5" Contemporary Post Cap	73013124	N/A
5" x 5" Contemporary Solar Post Cap	73013110	N/A
6" x 6" New England Post Cap	73018108	73018106
6" x 6" Elite Post Cap	73018105	N/A



Flat Post Cap



New England Post Cap



4" Elite Post Cap



6" Elite Post Cap

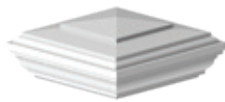

Heritage Post Cap



Contemporary Post Cap

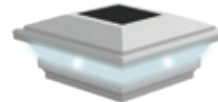

Contemporary Solar Post Cap

Vinyl Trim Rings		
Description	White	Clay
4" x 4" Elite Trim Ring	73018091	73018092
4" x 4" Heritage Trim Ring*	73012503	73053674
4" x 4" Low Profile Trim Ring	73045041	73053680
5" x 5" 2-Piece Trim Ring	73043929	N/A
3.5" to 6.5" – 4-Piece Elite Trim Ring**	73018131	73018066
6" x 6" Low Profile Trim Ring	73055142	N/A

*The Heritage Trim Ring complements the New England Post Cap and the Heritage Post Cap. Does not allow for a 2" bottom space when used with Endurance Original Rail.

**Adjustable Elite 4-Piece Trim Ring can be installed at any time and can be adjusted to fit posts from 3½" x 3½" to 6½" x 6½" without nails, screws or glue.



Elite Trim Ring

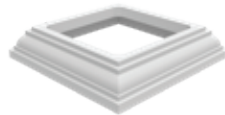

Heritage Trim Ring



Low Profile Trim Ring



5" 2-Piece Trim Ring



4-Piece Elite Trim Ring

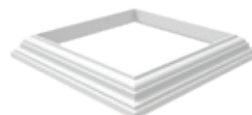

6" Low Profile Trim Ring

1¼" Square Baluster Kits

Description	White	Clay
4' x 36" H – Level Rail Kit	73018509	N/A
6' x 36" H – Level Rail Kit	73018009	73053618
8' x 36" H – Level Rail Kit	73018000	73053619
10' x 36" H – Level Rail Kit	73018498	N/A
6' x 36" H – 32 Degree to 38 Degree Stair Rail Kit	73019104	73053624
8' x 36" H – 32 Degree to 38 Degree Stair Rail Kit	73019116	73053627
6' x 42" H – Level Rail Kit	73018705	73053622
8' x 42" H – Level Rail Kit	73018708	73053623
8' x 42" H – 32 Degree to 38 Degree Stair Rail Kit	73019125	73053629

Kits include top and bottom rails with aluminum stiffeners, balusters, bracket kit and installation hardware. Support foot required and sold separately for all installed rail lengths over 8'.

¾" Round Aluminum Baluster Kits

Description	White	Clay
6' x 36" H – Level Rail Kit	73018553	73053620
8' x 36" H – Level Rail Kit	73018558	73053621
10' x 36" H – Level Rail Kit	73018547	N/A
6' x 36" H – 32 Degree to 38 Degree Stair Rail Kit	73019110	73053625
8' x 36" H – 32 Degree to 38 Degree Stair Rail Kit	73019122	73053628

Kits include top and bottom rails with aluminum stiffeners, balusters, bracket kit and installation hardware. Support foot required and sold separately for all installed rail lengths over 8'.

1¼" Turned Baluster Kits

Description	White
6' x 36" H – Level Rail Kit – 1¼" Turned Baluster	73018633
8' x 36" H – Level Rail Kit – 1¼" Turned Baluster	73018636
10' x 36" H – Level Rail Kit – 1¼" Turned Baluster	73018626
8' x 36" H – 32 Degree to 38 Degree Stair Rail Kit – 1¼" Turned Baluster	73019119

Kits include top and bottom rails with aluminum stiffeners, balusters, bracket kit and installation hardware. Support foot required and sold separately for all installed rail lengths over 8'.



1¼" Square Balusters



¾" Round Aluminum Balusters



1¼" Turned Balusters

Glass Slat Beam Kits	
Description	White
6' Level Beam Kit – for Glass Slats – Requires 9 Level Glass Slats	73018530
8' Level Beam Kit – for Glass Slats – Requires 12 Level Glass Slats	73018540

Kits include top and bottom rails with aluminum stiffeners, bracket kit, support foot and installation hardware. Glass slats sold separately.

Glass Slats		
Description	36"	42"
Glass Slats for Level Kits – Box of 9 – For Use with 6' Kits	73041331	73041332
Glass Slats for Level Kits – Box of 12 – For Use with 8' Kits	73041333	73041334

42" glass slats for residential use only. Support foot required and included for glass railing sections 6' to 8'.



4 1/8" Glass Slats (Level only)

Accessories		
Description	White	Clay
Level Mounting Bracket Kit – 2 Pairs	73019016	73019018
Stair Mounting Bracket Kit – 2 Pairs	73019017	73019019
0 Degree to 44 Degree Level Mounting Bracket Kit – 1 Pair	73018065	73018017
45 Degree Level Mounting Bracket Kit – 1 Pair	73018086	73018084
Round Column Mounting Bracket Kit – 1 Pair	73018115	73018113
Paintable Round Column Mounting Bracket Adapter Kit – 1 Pair	73018116	N/A
2" to 4" Level Rail Support Kit	73018129	73018127

Level rail support required for lengths over 8' (10' panels being used at any lengths longer than 8'). Endurance Original Rail kits (except glass kits) do not include a support foot.



Level Mounting Bracket Kit



Stair Mounting Bracket Kit



0 Degree to 44 Degree Level Mounting Bracket Kit*



45 Degree Mounting Bracket Kit



Round Column Mounting Bracket Kit For 8" Columns



Paintable Round Column Bracket Adapter Kit for 8" Columns

Vinyl Rail Gate Kits

Description	White	Clay
Standard Width Gate Kit – 36" H – 1¼" Square Balusters	73018135	N/A
Custom Width Gate Kit – 36" H – 1¼" Square Balusters	73045025	N/A
Custom Width Gate Kit – 36" H – 1½" Square Balusters	73045028	73053676
Custom Width Gate Kit – 36" H – 1¼" Turned Balusters	73045034	N/A
Custom Width Gate Kit – 36" H – 1½" Turned Balusters	73045044	73053681
Custom Width Gate Kit – 36" H – ¾" Round Aluminum Balusters	73045031	73053677
Custom Width Gate Kit – 42" H – 1¼" Square Balusters	73045035	N/A
Custom Width Gate Kit – 42" H – 1½" Square Balusters	73045038	73053679

Standard gate kit has a maximum opening width of 36". Custom gate kits have a maximum width opening up to 48". Gate kits include everything to build a gate panel. Gate hardware sold separately.



Standard Gate Kit



Custom Gate Kit

Vinyl Gate Hardware

Description	Black	White
Standard Wrap Hinge Pair	73028117	73025512
Two-Sided Locking Latch	73050187	73050188
Gravity Latch	73002252	73025491
24" Heavy-Duty Drop Rod	73014305	73014306

LED lighting options are available for use with Endurance Original Rail. For details and options, see page 80.

Titan Pro Rail®



Titan Pro Rail Vinyl Railing — created with the installer in mind — features rail sections that assemble in minutes and metal-to-metal connections that are engineered for easy and safe installation. Panels are supported by structural steel posts clad in low-maintenance vinyl. Titan Pro Rail is ideal for residential and commercial applications.

- Structural steel vinyl-clad posts provide superior strength and support
- Hidden fasteners provide a clean, finished look
- Posts feature pre-attached brackets
- Code compliant and easy to maintain
- Transferable Limited Lifetime Warranty



White



How to Shop:

Square Balusters with Titan Posts

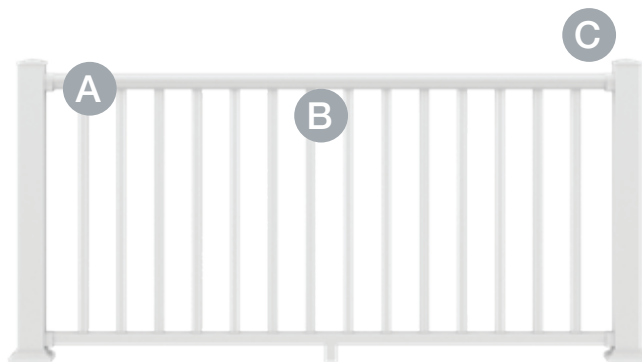

A Pick Your Posts

Titan Pro Rail posts include a flush mount steel post insert with vinyl sleeve and pre-attached brackets (except blank post).

B Pick Your Rail Kit

Includes top and bottom rails with aluminum stiffeners, balusters and a support foot. Brackets included with posts or sold separately if needed.

C Pick Your Accessories

Post caps must be purchased separately – choose from 2 styles.

Square Balusters with Vinyl Posts

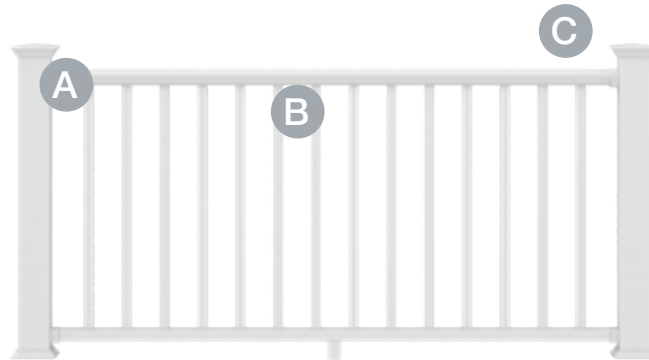

A Pick Your Posts

Post sleeves available for wooden 4" x 4" or structural posts.

B Pick Your Rail Kit

Includes top and bottom rails with aluminum stiffeners, balusters and a support foot. Brackets sold separately and required.

C Pick Your Accessories

Post caps and LED post caps as well as a variety of trim rings available for 4" x 4" sleeved post options; 4" x 4" Low Profile trim ring is recommended for this installation.

Post Kits – with 2" Bottom Space	
Description	White
3.4" x 3.4" x 38.125" Blank Post Assembly for 36" Railing Height	73018657
3.4" x 3.4" x 38.125" End Post Assembly for 36" Railing Height	73018662
3.4" x 3.4" x 38.125" Mid Post Assembly for 36" Railing Height	73018664
3.4" x 3.4" x 38.125" Corner Post Assembly for 36" Railing Height	73018660
3.4" x 3.4" x 44.125" Blank Post Assembly for 42" Railing Height	73018658
3.4" x 3.4" x 44.125" End Post Assembly for 42" Railing Height	73018663
3.4" x 3.4" x 44.125" Mid Post Assembly for 42" Railing Height	73018665
3.4" x 3.4" x 44.125" Corner Post Assembly for 42" Railing Height	73018661
3.4" x 3.4" x 50.125" Blank Post Assembly for 42" Railing Height (for stairs)	73018659

Post kits include steel post insert, vinyl sleeve, brackets with covers (except blank posts), trim ring and two vinyl shims. Titan posts with sleeve are 3.4" x 3.4" square and bottom brackets are set for a 2" bottom space.



Blank Post



End Post



Mid Post



Corner Post

Post Accessories	
Description	White
Flat Post Cap	73018242
Decorative Post Cap	73018240

For other post options (including 4" x 4", 5" x 5", 6" x 6" and structural posts) and additional accessories if not using a Titan post, see our vinyl posts and post accessories on page 47. Only the Low Profile or 4-piece Adjustable trim ring provide sufficient clearance for Titan bottom brackets.



Flat Post Cap



Decorative Post Cap

Rail Kits – 1¼" Square Baluster

Description	White
6' x 36" H – Level Rail Kit	73018163
8' x 36" H – Level Rail Kit	73018012
10' x 36" H – Level Rail Kit	73018157
6' x 36" H – 32 Degree to 38 Degree Stair Rail Kit	73018200
8' x 36" H – 32 Degree to 38 Degree Stair Rail Kit	73018207
6' x 42" H – Level Rail Kit	73018167
8' x 42" H – Level Rail Kit	73018173
10' x 42" H – Level Rail Kit	73018161
6' x 42" H – 32 Degree to 38 Degree Stair Rail Kit	73018204
8' x 42" H – 32 Degree to 38 Degree Stair Rail Kit	73018211

Brackets not included in rail kits. Titan posts come with pre-attached brackets for ease of install for level applications; if not using Titan posts, level brackets must be purchased separately from your rail kit. Stair brackets sold separately.



1¼" Square Balusters

Bracket Accessories	
Description	White
Level Bracket Kit – 2 Pair (4 steel brackets and 4 vinyl bracket covers)	73018011
Stair Bracket Kit – 2 Pair (4 steel brackets and 4 vinyl bracket covers)	73018229
No-Cut Stair Bracket Kit – 2 Pair	73018230
45 Degree Bracket Adapter Kit – 1 Pair	73018225
22.5 Degree Bracket Adapter Kit – 1 Pair	73018223
Round Column Adapter Kit – 1 Pair	73018251
2-Piece Trim Ring*	73018915

*Titan posts include 2-piece trim ring; if a replacement is needed, this item can be ordered.



Level Bracket Kit



Stair Bracket Kit



No-Cut Stair Bracket Kit



45 Degree Bracket Adapter



22.5 Degree Bracket Adapter



Round Column Adapter for 8" Columns



2-Piece Trim Ring

Vinyl Rail Gate Kits

Description	White
Standard Width Gate Kit – 36" H – 1¼" Square Balusters	73018135
Custom Width Gate Kit – 36" H – 1¼" Square Balusters	73045025
Custom Width Gate Kit – 42" H – 1¼" Square Balusters	73045035

Standard gate kit has a maximum opening width of 36". Custom gate kits have a maximum width opening up to 48". Gate kits include everything to build a gate panel. Gate hardware sold separately.



Standard Gate Kit



Custom Gate Kit

Vinyl Gate Hardware

Description	Black	White
Standard Wrap Hinge Pair	73028117	73025512
Two-Sided Locking Latch	73050187	73050188
Gravity Latch	73002252	73025491
24" Heavy-Duty Drop Rod	73014305	73014306

LED lighting options are available for use with Titan Pro Rail.
For details and options, see page 80.

Vinyl ADA Handrail



Vinyl ADA Handrail is a code compliant graspable handrail that provides added safety and security to stairs and ramps. Featuring versatile components and metal-to-metal connections for maximum strength, this system can be joined in many different configurations.

- Metal-to-metal connections for maximum strength
- Versatile components that can accommodate angles up to 90 degrees
- Code compliant and easy to maintain
- Transferable Limited Lifetime Warranty



White



Vinyl ADA Handrail

How to Shop



A ADA Handrail lineals are available in multiple lengths as well as a 180 degree return loop to meet ADA graspability requirements.

B Internal adjustable joiner allows you to create the angle you need from 0 degree to 90 degrees.

C Mounting brackets attach to your wall or rail posts to support Handrail lineals. Returns terminate the lineal to your wall or post.

D Complete your install with accessories like the Handrail end cap to hide lineal ends for a finished look.

Vinyl ADA Handrail – Lineals

Description	White
120" Vinyl Clad Aluminum Lineal	73018380
104" Vinyl Clad Aluminum Lineal	73018377
80" Vinyl Clad Aluminum Lineal	73018381
180 Degree Return Loop	73018392



Vinyl Clad Aluminum Lineal



180 Degree Return Loop

Vinyl ADA Handrail – Mounting Brackets

Description	White
Mounting Bracket	73018384
Inside Corner Mounting Bracket	73018394
90 Degree Post Return	73018398
Straight Wall Return	73018402

A mounting bracket is required every 6' of Handrail lineal. Hardware to attach mounting brackets to lineals included; hardware to attach to posts not included.



Mounting Bracket



Inside Corner Mounting Bracket



90 Degree Post Return



Straight Wall Return

Vinyl ADA Handrail – Joiners

Description	White
90 Degree Corner	73018386
Internal Adjustable Joiner (no color)	73018382
Internal Straight Joiner (no color)	73018399

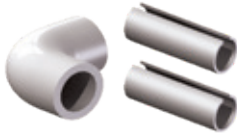

90 Degree Corner



Internal Adjustable Joiner



Internal Straight Joiner

Vinyl ADA Handrail – Accessories

Description	White
Joint Ring	73018396
End Cap	73018390



Joint Ring



End Cap

Aluminum ADA Handrail



Aluminum ADA Handrail is the perfect solution for applications where durable, low-maintenance, graspable metal handrail is desired. Strong, metal-to-metal connections ensure dependable safety and security for any stair or ramp that requires ADA code compliance.

- Metal-to-metal connections for maximum strength
- Versatile components that can accommodate angles up to 90 degrees
- Code compliant and easy to maintain
- Premium powder coating meets and exceeds AAMA 2604 specifications
- Transferrable Limited Lifetime Warranty



Aluminum ADA Handrail

How to Shop

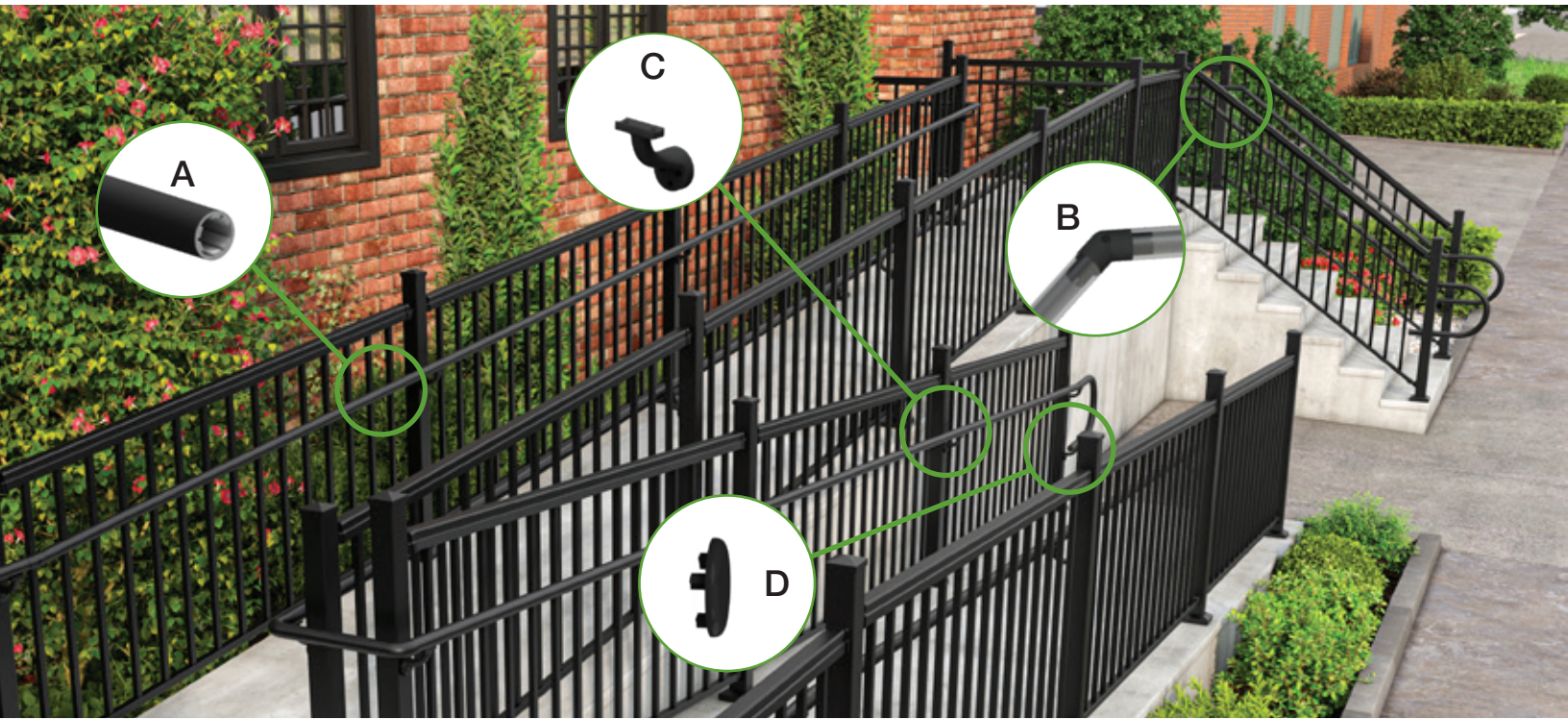

A ADA Handrail lineals are available in multiple lengths as well as a 180 degree return loop to meet ADA graspability requirements.

B Our innovative external adjustable joiner fits securely into the lineals & allows installations of angles up to 45 degrees.

C Mounting brackets attach to wall or rail posts to support Handrail lineals. Cast aluminum straight return fits neatly into the lineal and terminates the lineal to any wall or post.

D Complete your install with accessories like the Handrail end cap to hide lineal ends for a finished look.

Aluminum ADA Handrail – Lineals				
Description	White	Matte Black	Hammered Bronze	Matte Bronze
1½" x 80" Aluminum Lineal	73019171	73019169	73019170	73041311
1½" x 104" Aluminum Lineal	73019175	73019173	73019174	73041309
1½" x 120" Aluminum Lineal	73019179	73019177	73019178	73041310
180 Degree Return Loop	73019227	73019229	N/A	73041325



Aluminum Lineal



180 Degree Return Loop

Aluminum ADA Handrail – Mounting Brackets

Description	White	Matte Black	Hammered Bronze	Matte Bronze
Mounting Bracket	73019151	73019149	73019150	73041323
Mounting Bracket for Vinyl Posts	N/A	73042847	N/A	N/A
Inside Corner Mounting Bracket	73041318	73041317	N/A	73041315
90 Degree Post Return	73019147	73019145	73019146	73041324
90 Degree Post Return for Vinyl Posts	N/A	73042848	N/A	N/A
Straight Wall Return	73019155	73019153	73019154	73041326

A mounting bracket is required every 6' of Handrail lineal. Hardware to attach mounting brackets to steel or aluminum posts included and hardware for vinyl posts included in brackets indicating use for vinyl posts.



Aluminum ADA Handrail – Joiners

Description	White	Matte Black	Hammered Bronze	Matte Bronze
External Adjustable Joiner	73019167	73019165	73019166	73041314
Internal Straight Joiner (no color)	73018399			
90 Degree Corner	73019163	73019161	73019162	73041312



Aluminum ADA Handrail – Accessories

Description	White	Matte Black	Hammered Bronze	Matte Bronze
End Cap	73019159	73019157	73019158	73041313
Joint Ring	73041322	73041321	N/A	73041319
Spacer Block*	73041469	73042849	N/A	73043094

*Spacer Block is 1/4" thick and used to help block out brackets for narrower, 2" Over-the-Top in-line Avalon posts installed between standard 2 1/2" Avalon posts.



Lighting



Finyl Line T-Top with square balusters in White with Contemporary LED Light Post Caps, Dome Lights and Side/Stair Lights (set in stairs).

Solar Post Caps and a full LED Lighting system are available for use with all RDI vinyl, aluminum and steel railing products. Under-rail LED lighting strips feature an adhesive backing and easily connect with a 50W Bluetooth+WiFi compatible transformer. Additional LED accessories include post caps, dome lights, flush deck and side/stair lights.

- LED plug-and-play lighting system does not require cutting or splicing of wires
- Long-lasting, true white LED lights — rated at 50,000 hours
- Adjust and control lighting with smartphone
- Transformer is Bluetooth+WiFi compatible and can work with Alexa and Google Home
- Post cap and/or under-rail LED lighting options
- Limited Warranty

LED Lighting Features



- A** LED plug-and-play lighting system does not require cutting or splicing of wires
- B** Under-rail light channel available for certain railing styles

- C** Long-lasting, true white LED lights — rated at 50,000 hours
- D** Adjust and control lighting with smartphone, Google Home and Alexa

Aluminum Rail – Lighted Accessories			
Description	White	Matte Black	Matte Bronze
2½" 3-in-1 LED Light Post Cap (1.6W)	73021946	73021947	73021948
2½" Solar Light Post Cap	73044955	73044954	73044941
2½" Solar Down Light Post Cap	73044936	73044935	73044953
4¼" Solar Light Post Cap	73050527	73050526	73050528
4¼" LED Light Post Cap (0.80W)	73050524	73050523	73050525
92" Under-Rail LED Lighting (3W for 92" length)	73019376		
Flush Deck Light (0.40W)	73019403		



3-in-1 LED Light Post Cap



Solar Light Post Cap



Solar Down Light Post Cap

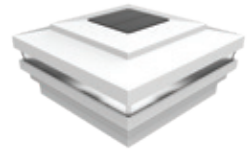

4¼" Solar Light Post Cap

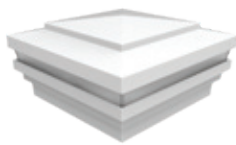

4¼" LED Light Post Cap



92" Under-Rail LED Lighting (3W)



Flush Deck Light (0.40W)

Steel Rail – Lighted Accessories	
Description	Matte Black
2" LED Post Cap (0.80W)	73043000
3" LED Post Cap (0.80W)	73043001
2" Solar Down Light Post Cap	73044933
3" Solar Down Light Post Cap	73044934
Flush Deck Light (0.40W)	73019403

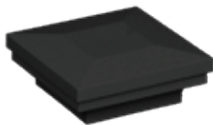

LED Lighted Post Cap (2" or 3")

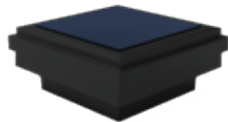

Solar Down Light Post Cap (2" or 3")



Flush Deck Light (0.40W)

Vinyl Rail – Lighted Accessories

Description	White	Clay	Sand
4" x 4" Contemporary Solar Post Cap	73019234	73045510	73045511
4" x 4" Contemporary LED Post Cap (0.80W)	73019377	73045506	73045507
5" x 5" New England LED Post Cap (0.80W)	73043928	N/A	N/A
5" x 5" Contemporary Solar Post Cap	73013110	N/A	N/A
Dome Light (0.80W)	73019404	73045508	73045509
Side/Stair Light (0.40W)	73019411	N/A	N/A
92" Under-Rail LED Lighting (3W for 92" length)	73019376		
Flush Deck Light (0.40W)	73019403		

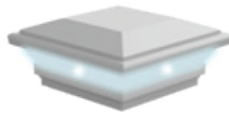

Contemporary Post Cap (Solar or LED)

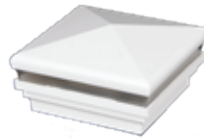

New England LED Post Cap (0.80W)



Dome Light (0.80W)



Side/Stair Light (0.40W)

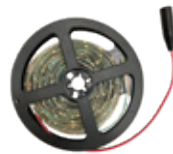

92" Under-Rail LED Lighting (3W)



Flush Deck Light (0.40W)

LED Lighting – Components

Description	SKU
Bluetooth Transformer for LED Lighting System	73041277
2-Way Splitter	73019370
5-Way Splitter	73019371
2' Electrical Lighting Wire	73032449
5' Electrical Lighting Wire	73019375
7' Electrical Lighting Wire	73019373
9' Electrical Lighting Wire	73019374
92" Under-Rail Light Channel (10 pack for use with Endurance Original Rail, Finyl Line and Titan Pro Rail) – WHITE	73024866

Transformer is 50W. Includes photocell, built-in dimmer and timer. Transformer is Bluetooth capable; "SmartPower50" app available from the App Store and Google Play.



Transformer (50W) with Bluetooth and WiFi capability



2-Way Splitter



Lighting Wire – available in 2', 5', 7' or 9' lengths.



5-Way Splitter



Under-Rail Light Channel (92" length)



The perfect complement to your outdoor or indoor living space, our complementary accents allow you to get creative and easily enhance a room, deck, patio or garden area. Freestyle Complementary Accents include Decorative Screen Panels and Lattice to create privacy and semi-privacy solutions, Pergola, and EncloSure Screen System to extend your outdoor space.

Decorative Screen Panels



Lattice



Pergola



EncloSure Screen System



Decorative Screen Panels

Decorative Screen Panels offer a unique and attractive way to customize an indoor or outdoor setting. Allowing for creativity with privacy screening, Decorative Screen Panels are the perfect home accent to enhance a room, patio, garden or a stylish solution for under a deck. Panels can also be installed up to three high in our aluminum Frame Kit — creating a divider screen for increased privacy wherever it is needed.

- Low-maintenance, impact resistant material ensures stability in extreme climates
- Select designs feature a dimensional effect for added realism
- Resists warping, rot, twisting, splitting, discoloration and scratching
- Available in 8 designs and 2 sizes
- Paintable
- Limited Lifetime Warranty

Decorative Screen Panel Colors



Frame Kit Color



Decorative Screen Panel Frame Kits with Corner Post and Boardwalk Decorative Screen Panels in Umber.

2' x 4' Decorative Screen Panels

Description	Black	White	Gray	Umber
2' x 4' x 0.3" Boardwalk Decorative Screen Panel	73042822	73042821	73050384	73055917
2' x 4' x 0.3" Morse Decorative Screen Panel	73004796	73004795	73050383	N/A
2' x 4' x 0.3" Sprig Decorative Screen Panel	73004791	73004790	73050382	73055918
2' x 4' x 0.3" Sanibel Decorative Screen Panel	73050358	N/A	N/A	73050359
2' x 4' x 0.3" Aztek Decorative Screen Panel	73055263	N/A	N/A	N/A
2' x 4' x 0.3" Freesia Decorative Screen Panel	73055262	N/A	N/A	N/A

Actual size: 23.88" x 47.88" x 0.3".

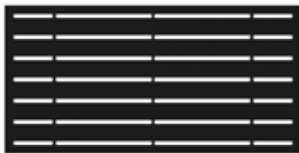

Boardwalk
US Des. Pat. No. D889,142



Morse
US Des. Pat. No. D843,607

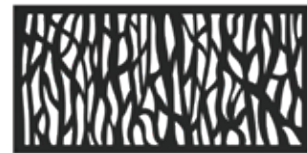

Sprig
US Des. Pat. No. D843,605



Sanibel
Design Patent Pending



Aztek
Design Patent Pending

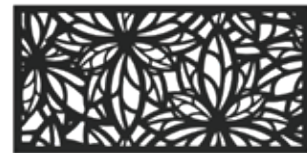

Freesia
Design Patent Pending

3' x 6' Decorative Screen Panels

Description	Black	White	Gray
3' x 6' x 0.3" Boardwalk Decorative Screen Panel	73030561	73045664	73045665
3' x 6' x 0.3" Sanibel Decorative Screen Panel	73050460	N/A	N/A
3' x 6' x 0.3" River Rock Decorative Screen Panel	73045667	N/A	N/A
3' x 6' x 0.3" Optic Decorative Screen Panel	73050083	N/A	N/A

Actual size: 34" x 68" x 0.3".



Boardwalk



Sanibel
Design Patent Pending

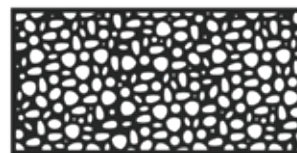

River Rock

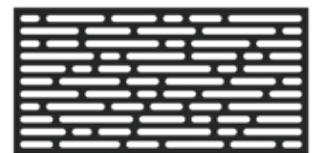

Optic

Decorative Screen Panels are designed with a matte, textured finish to allow them to be painted for complete customization.

Decorative Screen Panels

Decorative Screen Panel Hardware	
Description	
Fastener Kit (12 stainless steel screws and 12 color matched screw covers) – White	73025526
Fastener Kit (12 stainless steel screws and 12 color matched screw covers) – Gray	73050385
Fastener Kit (12 stainless steel screws and 12 color matched screw covers) – Umber	73050380
Fastener Kit (12 stainless steel screws and 12 color matched screw covers) – Black	73025527

Decorative Screen Panel Frame Kits (Posts Included)	
Description	Matte Black
2' x 4' Horizontal Frame Kit (holds up to three 2' x 4' Decorative Screen Panels — sold separately)	73050431
2' x 4' Line Post Kit (use with Frame Kit to create a continuous section)	73050432
2' x 4' Corner Post Kit (use with Frame Kit to create a corner section)	73050433
3' x 6' Horizontal Frame Kit (holds up to two 3' x 6' Decorative Screen Panels — sold separately)	73050434
3' x 6' Vertical Frame Kit (holds one 3' x 6' Decorative Screen Panel — sold separately)	73050437
3' x 6' Line Post Kit (use with Horizontal or Vertical Frame Kit to create a continuous section)	73050435
3' x 6' Corner Post Kit (use with Horizontal or Vertical Frame Kit to create a corner section)	73050436

2' x 4' Decorative Screen Panel Frame Kits contain two 2" aluminum end posts, two top/bottom U-channels, two mid H-channels, surface mounting kit, post caps and hardware.

3' x 6' Decorative Screen Panel Frame Kits contain two 2" aluminum end posts, two top/bottom U-channels, one mid H-channel, surface mounting kit, post caps and hardware.

Line and Corner Post Kits contain one 2" aluminum post (for either line or corner orientation), two top/bottom U-channels, two mid H-channels (1 for a 3' x 6'), surface mounting kit, post cap and hardware.



2' x 4' Frame Kit
(Decorative Screen Panels sold separately)



3' x 6' Horizontal Frame Kit
(Decorative Screen Panels sold separately)



3' x 6' Vertical Frame Kit
(Decorative Screen Panels sold separately)



Line Post Kit



Corner Post Kit

Decorative Screen Panel Frame Kit (Posts Not Included*)

Description	Matte Black
2' x 4' Frame Kit (holds up to three 2' x 4' Decorative Screen Panels — sold separately)	73055202

2' x 4' Decorative Screen Panel Frame Kits contain two vertical channels, two top/bottom U-channels, two mid H-channels, 14 DSP clips and hardware. Can be mounted on any flat post (sold separately).

*Can be used with any blank or flat post of your choice.



Aluminum Frame Kit for 2' x 4' Panels
(Decorative Screen Panels sold separately. Posts not included.)

Pergola

Perfect for smaller spaces, the 8' x 8' aluminum Pergola is a modern twist on traditional wood pergolas. Offering both form and function along with creating a unique outdoor living space for entertaining, dining and outdoor movies. Easy to assemble and install, the Pergola features a durable premium matte black powder coat that requires minimal maintenance. Pergola can be customized by adding any of our 2' x 4' Decorative Screen Panels (DSPs) to the roof, providing both privacy and shade. For additional privacy, an optional Side Wall Kit — featuring a rail that allows four DSPs to easily slide in — can be installed at any height.

- Easy assembly and installation
- Modern design, perfect for smaller spaces
- Durable premium powder coat requires minimal maintenance
- Customize by adding 2' x 4' Decorative Screen Panels as a roof or side walls
- Limited Lifetime Warranty

Pergola Color

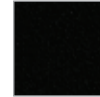

Matte Black



Pergola	
Description	Matte Black
8' x 8' Pergola – Uses eight 2' x 4' Decorative Screen Panels (sold separately)	73050386
Pergola Side Wall Add-on – Uses four 2' x 4' Decorative Screen Panels (sold separately)	73050387



8' x 8' Pergola
(Decorative Screen Panels
sold separately)



Side Wall Add-on
(Shown with Pergola. Pergola and
Decorative Screen Panels sold separately)

Lattice

Lattice panels are the perfect way to add privacy and conceal unsightly outdoor areas. Easy to maintain and install, durable plastic lattice is resistant to termites and other wood-eating pests. Lattice maintains its classic look without the need for sanding, staining or painting. Available in classic diamond, privacy diamond and privacy square patterns.

- Low-maintenance
- Impact resistant plastic
- Matching screws, cap, molding and divider molding available
- Resists warping and twisting
- Made in the USA
- Limited Lifetime Warranty

Colors



Lattice				
Color	Classic Diamond (2' x 8')	Classic Diamond (4' x 8')	Privacy Diamond (4' x 8')	Privacy Square (4' x 8')
White	73004010	73004026	73004042	73004051
Woodland Green	N/A	73004020	73004037	N/A
Sierra Cedar	N/A	73004021	73004038	N/A
Redwood	N/A	73004023	73004040	N/A
Clay	N/A	73054359	73054360	N/A
Brazilian Walnut	N/A	73004144	73004142	N/A
Nantucket Gray	N/A	73004145	73004143	N/A
Black	N/A	73004497	73004479	73053435
Espresso	N/A	73053436	73053437	N/A

Lattice comes in a variety of color options and is NOT intended to be painted.



Lattice Accessories			
Color	Cap Molding	Divider Molding	1½" Color-Matched Screws*
White	73004058	73004066	73003464
Woodland Green	73004057	73004079	73003466
Sierra Cedar	73004059	73004067	73003467
Redwood	73004061	73004069	73003470
Clay	73054361	73054362	73003469
Brazilian Walnut	73004140	73004138	73003999
Nantucket Gray	73004141	73004139	73013281
Black	73004496	73004477	73014290
Espresso	73053438	73053439	73053440

*Color-Matched Screws are stainless steel and come in packs of 12.



Cap Molding



Divider Molding



1½" Color-Matched Screws

EncloSure™ Screen System

Freestyle's DIY-friendly screen enclosure solution — EncloSure™ — allows homeowners to enjoy being outdoors while offering protection against insects and the elements. Able to be installed into an existing covered patio, deck or upper balcony, EncloSure easily creates an extra space for entertaining and allows for increased privacy. Made of durable aluminum framing featuring a premium powder coat and high-quality screening with a flat spline technology that ensures screens stay in place even in the windiest conditions. With an easy four step purchasing system, homeowners can select from three sizes that best fits their existing covered space and, if needed, adjust post and rail sizes using a miter or circular saw. Additional options like a railing infill kit, screen door and in-swing kit are also available.

- Durable aluminum framing with premium powder coat
- High-quality pool and patio screen for large enclosures
- DIY-friendly with easy four step purchasing system
- Limited Lifetime Warranty

Frame Colors



White



Matte Black



Charcoal
Bronze

Screen Color



Charcoal

Step 1



Start with the Framing Kit for the inside perimeter of your opening.

Step 2

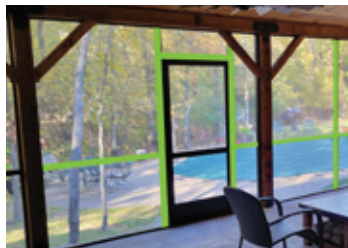

Choose Divider Post Kits to divide the open area with a vertical 2' x 2', a horizontal 2' x 2' as a chair rail or to frame a screen door.

Step 3



Consider a Screen Railing Infill Kit for a covered, upper deck or balcony.

Step 4



Choose from 50' rolls of 5', 6', 7', 8' and 9' x 100'.



Frame Kits — Step 1: Start with the framing kit for the inside perimeter of your opening

Description	White	Matte Black	Charcoal Bronze
1" x 2" x 8'* Frame Kit 4-Pack (includes spline and fasteners)	73057001	73057000	73057527
1" x 2" x 10' Frame Kit 4-Pack (includes spline and fasteners)	73057069	73057070	73057529
1" x 2" x 12' Frame Kit 4-Pack (includes spline and fasteners)	73057140	73057121	73057530

*1" x 2" x 8' actual size is 1" x 2" x 95¼"

Divider Post Kits — Step 2: Choose divider post kits to divide the open area with a vertical and/or horizontal post

Description	White	Matte Black	Charcoal Bronze
2" x 2" x 8'* Divider Post Kit 2-Pack (includes bracket clips, spline & fasteners)	73057148	73057141	73057531
2" x 2" x 10' Divider Post Kit 2-Pack (includes bracket clips, spline & fasteners)	73057201	73057191	73057532
2" x 2" x 12' Divider Post Kit 2-Pack (includes bracket clips, spline & fasteners)	73057218	73057202	73057533

*2" x 2" x 8' actual size is 2" x 2" x 95¼"

Screen Railing Infill Kits — Step 3: Consider a railing system for a covered deck or balcony

Description	White	Matte Black	Charcoal Bronze
6' Screen Railing Infill Kit with 1" Square Balusters Kit	73057245	73057244	73057534
8'* Screen Railing Infill Kit with 1" Square Balusters Kit	73057351	73057326	73057535

*8' actual size is 95¼"

Screens — Step 4: Select your desired screen size

Description	Charcoal
60" x 50' Pool and Patio 18/14 Mesh Screen Roll	73050089
72" x 50' Pool and Patio 18/14 Mesh Screen Roll	73050686
84" x 50' Pool and Patio 18/14 Mesh Screen Roll	73050687
96" x 50' Pool and Patio 18/14 Mesh Screen Roll	73050688
108" x 100' Pool and Patio 18/14 Mesh Screen Roll	73050689

Screen Doors

Description	White	Satin Black*	Charcoal Bronze
36" x 80" Aluminum Screen Door with Hardware	73050712	73050698	73052588
80" Astragal for Double Doors	73050713	73050699	73052099
In-Swing Screen Door Handle Set	73050714	73050700	73052584

*Texture is not identical to texture of EncloSure Kit components.

Fasteners

Description	White	Matte Black	Charcoal Bronze
Bag of 25 Clips with 100 ¾" Self-Drilling Hex Color-Matched Fasteners	73057476	73057477	73057559
Bag of 25 2¼" Hex Head Color-Matched Tapcons	73057023	73057022	73057555
Bag of 50 #10 2" SMS Hex Head Color-Matched Fasteners	73057025	73057024	73057556
Bag of 100 #10 2" SMS Hex Head Color-Matched Fasteners	73057027	73057026	73057557
Bag of 50 #10 3" SMS Hex Head Color-Matched Fasteners	73057029	73057028	73057558

Spline and Screen Roller

Description	Black
.290" x 100' Flat Spline Roll	73050695
Screen Roller with Ball Bearing Wheels	73050697



An Oldcastle® APG Outdoor Brand
rdirail.com